



PROSMAN

PROFESIONALES EN MANTENIMIENTO Y LIMPIEZA

Somos limpieza, somos calidad, somos **PROSMAN.**

www.prosman.com.mx





Rubbermaid

®

Commercial Products

UTILITY REFUSE

DECORATIVE REFUSE

CLEANING

SAFETY

MATERIAL HANDLING

WASHROOM

FOODSERVICE

MEET OUR NEW PRODUCTS



SLIM JIM® RECYCLING STATION PAGE 30

The Slim Jim® Recycling Station offers a front-of-house look with back-of-house functionality. Intuitive lid openings help patrons and staff sort recyclables more effectively. A snap-in connector enables easy and efficient set-up without the use of tools or hardware.



SLIM JIM® UNDER-COUNTER PAGE 33

New Slim Jim® Under-Counter containers are designed with a large, angled opening, providing 2X more access under the counter than traditional slim containers.* This eliminates the need to pull containers out from under the counter, improving user productivity.

*Compared to 23G Vented Slim Jim® containers



THE NEW GENERATION WAVEBRAKE® PAGE 95

With features that surpass traditional mop buckets, the new generation of WaveBrake® helps to clean floors with less effort to get the job done safer, without sacrificing quality and durability. Patented WaveBrake® baffles result in less splashing while mopping and maneuvering, helping to create a safer environment for patrons and staff.



SPILL MOP PAGE 158

The Spill Mop helps clean up spills faster, so the floor dries quicker. Each Spill Mop Pad is made with highly absorbent material designed for quickly removing liquid, water-based spills, and each Biohazard Spill Mop Pad is made with highly absorbent material designed for quickly removing liquid, biohazard spills. Pads turn liquid into gel so that once liquid is fully absorbed, it will not drip.



HEAVY DUTY ADAPTABLE CART PAGE 171

The Heavy Duty Adaptable Cart provides superior versatility for tackling whatever task is at hand. It reduces the need for time-consuming user modifications with a variety of integrated features including: an ergonomic adjustable handle with four positions for maximum comfort, a flip-up shelf, locking casters, and numerous storage features designed to help organize tools and small parts.



FRESHWORKS™ PRODUCE SAVER PAGE 227

The FreshWorks™ Produce Saver regulates the flow of oxygen and ethylene, creating the optimal environment to store fruits and vegetables. By allowing the produce to “breathe”, the FreshWorks™ Produce Saver helps maintain their peak freshness for a longer period of time, reducing the amount of food thrown away due to spoilage.

UTILITY REFUSE AND RECYCLING

BRUTE® Utility and Recycling	12
Rollout Containers	17
Slim Jim® Containers & Accessories.....	22
Indoor/Outdoor Utility and Recycling Options	36
Steel Wastebaskets	42
Can Liners.....	43
Accessories	44

DECORATIVE REFUSE

Indoor/Outdoor Containers	48
Indoor Containers	51
Outdoor Containers	58
Smoking Management.....	65

CLEANING

HYGEN™ Microfiber	74
Microfiber.....	87
WaveBrake® Mopping Systems.....	95
Wet Mop Selection Guide	98
MAXIMIZER™ Wet Mops.....	102
Premium Wet Mops	103
Standard Wet Mops.....	107
Economy Wet Mops.....	110
Specialty and Finish Wet Mops	113
Wet Mop Handles.....	115
Mopping Accessories.....	117
Dust Mop Frames and Handles.....	125
Carpet Bonnets.....	125
Brooms.....	126
Brushes.....	130
Cleaning Brushes.....	131
Cleaning Tools	133
Cleaning Carts	138
Cleaning Cart Accessories.....	140
Traditional Housekeeping Carts and Accessories	142
Quick Carts	145
Mechanical Sweepers	147
Tools and Accessories	148

SAFETY

Safety Signs.....	154
Safety Cones.....	156
Barriers.....	157
Absorbents	157

MATERIAL HANDLING

Bulk Collection.....	164
Utility Carts.....	171
Platform Trucks	179
Caster Selection Guide.....	182
Accessories	183
Outdoor Handling and Storage	185
Storage.....	187

WASHROOM

Skin Care	191
Air Care	202
Fixtures.....	211
Surface Care	214
Accessories	216

FOODSERVICE

Storage.....	222
Preparation	232
Monitoring	234
Transport	237
Table Service.....	241
Youth Service.....	242

COMMON CONVERSIONS

Common Metric-English Conversions.....	244
--	-----

STANDARD COLOR GUIDE

Standard Color Guide	245
----------------------------	-----

INDEX







Product Index	246
Component Parts	275

CUSTOMER SERVICE 800-347-9800

WWW.RUBBERMAIDCOMMERCIAL.COM

©2019 Rubbermaid Commercial Products LLC
8900 Northpointe Executive Park Drive
Huntersville, NC 28078

CERTIFICATIONS

 <p>BS EN ISO 9001/Cleveland, TN 2000 Overhead Bridge Road Cleveland, Tennessee 37312, USA Certificate Number FM 33122</p> <p>Rubbermaid Commercial Products LLC operates a quality management system which complies with the requirements listed above.</p>	<p>ISTA International Safe Transit Association. The Compacted Mops were tested and certified via ISTA Test Procedures.</p> <p>UL Underwriters Laboratory. The UL Classified baskets (FG254000, FG254100, FG254200, FG254300, FG254400) meet the criteria for UL Standard 242 which is a standard of performance for open top, non-metallic wastepaper containers. UL classified baskets are generally found in use in patient care rooms (hospitals/nursing homes).</p> <p>Decorative Waste products that are UL Classified have been tested and approved only to burning paper containment and resistance to temperature rise of surrounding surfaces.</p> <p>Decorative Waste products that are UL Listed/FM Approved/Fire-Safe/Self-Extinguishing have been tested and approved for the fire-safe containment of dry flammable paper waste products.</p> 	<p>FDA Food and Drug Administration does not approve products. The FDA sets regulations which require compliance.</p> <p>NSF Registration Guidelines for Proprietary Substances and Nonfood Compounds:</p> <p>Handwashing and sanitizing products (Category Code E2): Combination of detergents-germicides (single step preparations designed to combine hand washing and sanitizing) will be considered for registration on the basis of their ability to effectively clean the hands as well as their germicidal equivalency to 50 ppm available chlorine. The hands need not be washed with soap or detergent prior to the use of such preparations. However, the hands must be rinsed with potable water after the use of the product and before handling food.</p> <p>Hand sanitizing products (Category Code E3): Products manufactured from those solutions described in CFR Title 21, Section 178.1010, which are applicable for the purpose may be used to sanitize the hands of employees handling food products without a subsequent rinse provided they are germicidally equivalent to 50 ppm available chlorine. Products shall not contain perfumes leaving a residual odor on hands after usage. These sanitizing solutions may be used only after thoroughly washing hands with soap or detergent and water, followed by rinsing with potable water. In many instances, these hand sanitizers may be injected directly into wash/rinse water.</p>
<p>ASTM ASTM 404-18 is an American Society for Testing and Materials safety standard for evaluating a High Chair. A "test dummy" that simulates a child of predetermined size is strapped into the chair and various push, pull, and racking tests are conducted on the chair and also using the dummy to simulate forces required to remove dummy, and to determine the safety aspects of ensuring proper confinement within the chair without causing harm to the child.</p> <p>ASTM 2285-04 is an American Society for Testing and Materials safety performance specification that establishes performance requirements, test methods, and labeling requirements to minimize the hazards to children presented by Diaper Changing Tables for commercial use with children up to 50 lbs.</p> 	<p>ADA</p> <ul style="list-style-type: none"> ■ The Americans with Disabilities Act prohibits discrimination and ensures equal opportunity for persons with disabilities in employment, state and local government services, public accommodations, commercial facilities, and transportation ■ Rubbermaid Commercial Products refuse containers need to comply with the ADA regulation; as long as "access openings" for containers are below 48", containers are compliant to ADA regulations ■ All Decorative Waste products comply with ADA Reach Range Requirements, except for step can models; all Decorative Waste wall mount models comply with ADA Reach Range Requirements, dependent upon height placement within the mandated "Reach Range"  <p>ADA COMPLIANT</p> <p>CE The CE marking (an acronym for the French "Conformite Europeenne") certifies that a product has met EU health, safety, and environmental requirements, which ensure consumer safety. Manufacturers in the European Union (EU) and abroad must meet CE marking requirements where applicable in order to market their products in Europe.</p> 	<p>CSFM California State Fire Marshal listing is obtained for various types of containers once tested (by independent testing laboratories) against specific criteria. Following our receipt of UL and/or FM approval for those items, the results were submitted/accepted by California. The State of California is generally regarded to have the most stringent fire codes of all the United States. For an annual fee (every June 30th) the CSFM listings are updated.</p> <p>Decorative Waste products that are UL Listed/FM Approved Fire-Safe/Self-Extinguishing and UL Classified are listed by the California State Fire Marshal pursuant to section 13144.1 of the California Health and Safety Code. See CSFM Listing No. 4480-1025:100.</p> <p>CSFM</p> <p>FM Factory Mutual is an independent testing agency whose approvals are based on Standard 6921 Combustible Waste Containers. Standard 6921 is performance criteria for containers with covers (lids) and their ability to withstand internal fires, maintain a certain range of stability, if dumped, and stay intact over a wide temperature range. Standard 6920 is performance criteria for Oily Waste Containers.</p> 

GREEN SEAL™

This product meets the Green Seal™ standard for institutional hand cleaners based on its reduced human and aquatic toxicity and reduced smog production potential.



HACCP

Hazard Analysis and Critical Control Points is a systematic method using principles (Food Hygiene Practices) for analyzing a food process and determining the possible chemical, physical, and biological hazards within that process that should prevent any unsafe food from leaving the process (this process could be for a food processing plant or food preparation in a restaurant).

The seven principles are: 1. Application, 2. HACCP Plan Validation, 3. Quality Manual Review, 4. On-site Readiness Review, 5. Registration Audit, 6. Registration, and, 7. Surveillance.

JOINT COMMISSION

The Joint Commission (formerly known as JCAHO) evaluates and accredits nearly 15,000 health care organizations and programs in the U.S. Joint Commission standards address the organization's level of performance in key functional areas, such as patient rights, patient treatment, and infection control.

US GREEN BUILDING COUNCIL

As a member of the United States Green Building Council, we are dedicated to promoting products for buildings that are environmentally responsible and healthy places to work. We offer over 1,000 products that contribute to buildings achieving LEED Certification. Visit www.rubbermaidcommercial.com for more information on USGBC and LEED Certification.



NFPA

Our Steel and Aluminum products comply with the National Fire Protection Association, Life Safety Code #101, section #31, which states wastebaskets and other waste containers shall be noncombustible.



NSF

National Sanitation Foundation is an independent testing lab/organization in Ann Arbor, Michigan. NSF lists products which meet their criteria for cleanability and sanitation: food contact, splash zone and non-food contact, per Standard 2: Food Equipment and Standard 18: Manual Beverage Dispensers. NSF 3-A USDA for equipment used in processing meat and poultry products. Also, Standard 21: Thermoplastic Refuse Containers.



EU

Regulation (EC) No 1935/2004 of the European Parliament and of the council on materials and articles intended to come into contact with food:

The purpose of this European Union Regulation is to ensure that materials and articles intended to come into contact directly or indirectly with food are safe in design and construction to protect the health of consumers.



OBRA

All UL Listed/ FM Approved Fire-Safe/Self-Extinguishing steel receptacles comply with the following Omnibus Budget Reconciliation Act of 1990 Nursing Home Reform Legislation regulations:

- Quality of Life-483.15(h)(1) Environment
- Dietary Service-483.35(h)(3) Disposal of Garbage and Refuse
- Infection Control-483.65(a) Infection Control Program (c) Storage of Linen
- Physical Environment-483.70(a) Life Safety From Fire (g)(2) Smoking Areas

OSHA

- Decorative Waste products comply with Occupational Safety and Health Administration (OSHA) Standard for Occupational Safety and Health Part 1910.141 Sanitation
- Defenders® Step Cans and Medi-Cans™ comply with OSHA Standard for Bloodborne Pathogens, Final Rule 29CFR, Part 1910.1030

LEGEND



Product is packaged for sale in a retail environment



Indicates Executive Series™ Product



Indicates products that contribute to Green Cleaning and Sustainability



UTILITY REFUSE AND RECYCLING

DECORATIVE REFUSE

CLEANING

MATERIAL HANDLING

WASHROOM

FOODSERVICE

ACCESSORIES
& INDEX



FG264360GRAY AND FG262073BLUE

UTILITY REFUSE AND RECYCLING



1956185, 1955959, 1956191

BRUTE® UTILITY AND RECYCLING

BRUTE® Utility Containers	12
BRUTE® Lids and Tops	13
BRUTE® Dollies	14
BRUTE® Outdoor Accessories	14
BRUTE® Cleaning Accessories	15
BRUTE® Square Containers	15

ROLLOUT CONTAINERS

BRUTE® Rollout	17
BRUTE® Step-On Rollout	17
BRUTE® Rollout with Casters	18
BRUTE® Step-On Rollout With Casters	18
BRUTE® Medical Waste Rollout With Casters	19

SLIM JIM® CONTAINERS

Slim Jim® Containers with Venting Channels	22
Slim Jim® Accessories	23
Slim Jim® Cleaning Accessories	24
Slim Jim® Lids	26
Slim Jim® Recycling Station	30
Slim Jim® Under-Counter Containers	33
Resin Slim Jim® Step-On Containers	35

INDOOR/OUTDOOR UTILITY REFUSE AND RECYCLING

Resin Step-On Containers	36
Untouchable® Containers and Tops	37
Deskside Waste and Recycling Baskets and Tops	38
Hide-A-Bag	39
Concept Collection™	39
Profile Containers	40
Fire-Resistant Wastebaskets	40
Recycling Boxes	41
Glutton® Recycling Stations	41

STEEL WASTEBASKETS

Steel Wastebasket Open Tops	42
Steel Wastebasket Dome Tops	42

CAN LINERS

Can Liners	43
High-Density Coreless Roll	43
Linear Low-Density	43

ACCESSORIES

Utility Refuse Waste Stream Label Kits	44
--	----



Resin-based product lines with this symbol contain, at minimum, 20% post-consumer recycled content on select colors and styles.



Metal-based products with this symbol contain, at minimum, 30% post-consumer recycled steel or 70% post-consumer recycled aluminum—which exceeds EPA guidelines.

LOOK FOR THE SPECIALLY MARKED EXECUTIVE SERIES™ PRODUCTS.



UTILITY REFUSE AND RECYCLING

BRUTE® CONTAINERS	12	SLIM JIM® ACCESSORIES	23
BRUTE® ACCESSORIES	13	UNTOUCHABLE® CONTAINERS AND TOPS	37
ROLLOUT CONTAINERS	17	DESKSIDE CONTAINERS & WASTEBASKETS	38
SLIM JIM® CONTAINERS	22		

INCREASE RECYCLING EFFECTIVENESS

IN-FIELD STUDIES YIELDED HIGH DIVERSION RATES

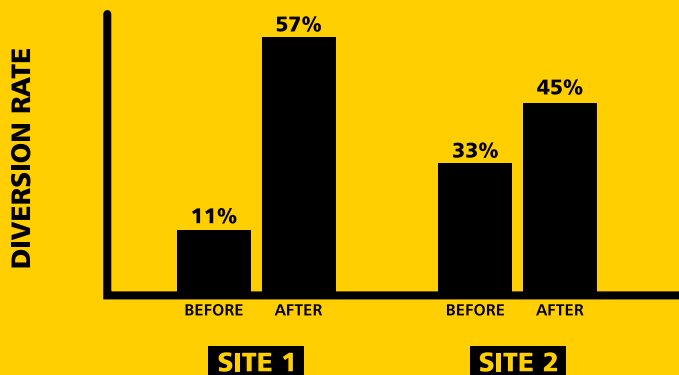

Improving recycling effectiveness has a positive environmental impact, helps facilities achieve sustainability initiatives, and can lead to cost savings. In-field trials that utilized colored containers, labels, lids with stream specific openings proved to increase recycling effectiveness.

In-field Recycling Study—July 2013

BRUTE® UTILITY CONTAINERS



50% EASIER TO LIFT LINERS

THE BRUTE® CONTAINER IS DESIGNED WITH FOUR BUILT-IN VENTING CHANNELS that create airflow throughout the container. This air circulation eliminates the vacuum effect that occurs when lifting out liners in traditional containers. By reducing the pull force required to lift out liners by up to 50%, the BRUTE® container improves productivity and reduces the risk of injury when compared to traditional containers.

UTILITY REFUSE
AND RECYCLING

DECORATIVE REFUSE

CLEANING

MATERIAL HANDLING

WASHROOM

FOODSERVICE

ACCESSORIES
& INDEX



BRUTE

COMMERCIAL-GRADE CONSTRUCTION

Proprietary design constructed with the highest quality material plus a UV inhibitor ensures long life in even the most extreme commercial environments. Guaranteed to never fade, warp, crack, or crush.



RIM WITH RIB-STRENGTHENED DESIGN

Increases strength and resists crushing.

BAG CINCHES

Secure liners allowing for knot-free liner changes. Tested to 20,000 cycles.

ROUNDED HANDLES

Make lifting and moving easier, and are reinforced to resist tearing or damage from even the heaviest loads.

SEAMLESS CONSTRUCTION

Helps make cleaning easier.

VENTING CHANNELS

Make removing liners up to 50% easier, improving productivity and reducing the risk of injury.



CONTOURED BASE HANDLES

Improve grip and ergonomics, reducing strain and improving efficiency when emptying containers.



REINFORCED BASE

Specifically engineered to be dragged over rough surfaces, extending life and durability in even the toughest environments.



UTILITY REFUSE
AND RECYCLING

DECORATIVE REFUSE

CLEANING

MATERIAL HANDLING

WASHROOM

FOODSERVICE

ACCESSORIES
& INDEX



2 & 21 Compliant

BRUTE® Utility Containers

Innovative venting channels make lifting out liners up to 50% easier, improving productivity and reducing the risk of injury.

- Integrated cinches secure the liner, allowing for efficient, knot-free liner changes. Tested to 20,000 cycles
- Proprietary design constructed with the highest quality material plus a UV inhibitor ensures long life in even the most extreme commercial environments. Guaranteed to never fade, warp, crack, or crush
- Rounded handles make lifting and moving easier, and are reinforced to resist tearing or damage from even the heaviest loads
- Reinforced base is specifically engineered to be dragged over rough surfaces, extending life and overall durability even in the toughest environments
- Rim features integrated rib structure to increase strength and resist crushing



Available in a wide range of colors and sizes to complement recycling initiatives and all other collection and sortation needs.



Waste Stream Label Kit

Waste Stream Label Kit Version A* (1977785) and Version C* () contain ten intuitive waste stream decals, ensuring waste sortation accuracy.



Vented BRUTE® Containers

NO.	COLOR	DESCRIPTION	U.S. DIMENSIONS	U.S. CAPACITY	U.S. SHIP WT/CTN	METRIC DIMENSIONS	METRIC CAPACITY	METRIC SHIP WT/CTN	CAN LINERS	PACK
FG261000	GRAY, WHT, RED, YEL, DGRN	BRUTE® Container without Lid	15.6" dia x 17.3" h	10 gal	18.5 lb	39.7 cm dia x 43.0 cm	37.9 L	8.4 kg	5003-88	6
1779699	BLUE	BRUTE® Container without Lid	15.6" dia x 17.3" h	10 gal	18.5 lb	39.7 cm dia x 43.0 cm	37.9 L	8.4 kg	5003-88	6
1926827	BLACK	BRUTE® Container without Lid	15.6" dia x 17.3" h	10 gal	18.5 lb	39.7 cm dia x 43.0 cm	37.9 L	8.4 kg	5003-88	6
FG262000	GRAY, WHT, BLUE, RED, YEL, DGRN	BRUTE® Container without Lid	19.5" dia x 22.9" h	20 gal	35.0 lb	49.5 cm dia x 58.1 cm	75.7 L	15.9 kg	5006-88	6
1779734	BLACK	Executive BRUTE® Container without Lid	19.5" dia x 22.9" h	20 gal	35.0 lb	49.5 cm dia x 58.1 cm	75.7 L	15.9 kg	5006-88	6
FG263200	GRAY, WHT, BLUE, RED, YEL, DGRN	BRUTE® Container without Lid	22.0" dia x 27.3" h	32 gal	47.0 lb	55.9 cm dia x 69.2 cm	121.1 L	21.3 kg	5007-88	6
1867531	BLACK	Executive BRUTE® Container without Lid	22.0" dia x 27.3" h	32 gal	47.0 lb	55.9 cm dia x 69.2 cm	121.1 L	21.3 kg	5007-88	6
FG264360	GRAY, BLUE, RED, YEL, BLA	BRUTE® Container without Lid	24.0" dia x 31.5" h	44 gal	49.5 lb	61.0 cm dia x 80.0 cm	166.6 L	22.4 kg	5008-88	4
1779740	WHITE	BRUTE® Container without Lid	24.0" dia x 31.5" h	44 gal	49.5 lb	61.0 cm dia x 80.0 cm	166.6 L	22.4 kg	5008-88	4
1779741	DARK GREEN	BRUTE® Container without Lid	24.0" dia x 31.5" h	44 gal	49.5 lb	61.0 cm dia x 80.0 cm	166.6 L	22.4 kg	5008-88	4
FG265500	GRAY, WHT, RED, YEL, DGRN	BRUTE® Container without Lid	26.4" dia x 33.0" h	55 gal	52.9 lb	67.0 cm dia x 83.8 cm	208.2 L	24.0 kg	5011-88	3
1779732	BLUE	BRUTE® Container without Lid	26.4" dia x 33.0" h	55 gal	52.9 lb	67.0 cm dia x 83.8 cm	208.2 L	24.0 kg	5011-88	3
1779739	BLACK	BRUTE® Container without Lid	26.4" dia x 33.0" h	55 gal	52.9 lb	67.0 cm dia x 83.8 cm	208.2 L	24.0 kg	5011-88	3

BRUTE® Recycling

NO.	COLOR	DESCRIPTION	U.S. DIMENSIONS	U.S. CAPACITY	U.S. SHIP WT/CTN	METRIC DIMENSIONS	METRIC CAPACITY	METRIC SHIP WT/CTN	PACK
FG262073*	BLUE	BRUTE® Recycling Container without Lid	19.5" dia x 22.9" h	20 gal	35.0 lb	49.5 cm dia x 58.1 cm	75.7 L	15.9 kg	6
1926828	GREEN	BRUTE® Recycling Container without Lid	19.5" dia x 22.9" h	20 gal	35.0 lb	49.5 cm dia x 58.1 cm	75.7 L	15.9 kg	6
FG263273*	BLUE	BRUTE® Recycling Container without Lid	22.0" dia x 27.3" h	32 gal	47.0 lb	55.9 cm dia x 69.2 cm	121.1 L	21.3 kg	6
1788472*	GREEN	BRUTE® Recycling Container without Lid	22.0" dia x 27.3" h	32 gal	47.0 lb	55.9 cm dia x 69.2 cm	121.1 L	21.3 kg	6
FG264307	BLUE	BRUTE® Recycling Container without Lid	24.0" dia x 31.5" h	44 gal	49.5 lb	61.0 cm dia x 80.0 cm	166.6 L	22.4 kg	4
1926829	GREEN	BRUTE® Recycling Container without Lid	24.0" dia x 31.5" h	44 gal	49.5 lb	61.0 cm dia x 80.0 cm	166.6 L	22.4 kg	4
2044156	BLUE	BRUTE® Recycling Container without Lid	26.4" dia x 33.0" h	55 gal	52.9 lb	67.0 cm dia x 83.8 cm	208.2 L	24.0 kg	4
1977785		Waste Stream Label Kit Version A fits 20-Gallon BRUTE® Containers	7.8" w x 4.7" h						10
1977787		Waste Stream Label Kit Version C fits 32- and 44-Gallon BRUTE® Containers	9.5" w x 5.7" h						10

*NSF Standards 2 and 21 do not apply to recycling containers.

BRUTE® Lids and Tops

Select from a wide range of lids for use in any environment.

SELF-DRAINING LIDS

- Self-draining channels prevent water from pooling, reducing still water buildup
- Snap-lock ensures a secure fit
- Ridges enable stacking of BRUTE® containers to provide a space-efficient storage solution
- Available in 7 colors



DOME TOP LIDS

- Spring action door allows for easy trash disposal while keeping odors in and insects out
- Snap-lock ensures a secure fit

BRUTE® RECYCLING LIDS*

- Intuitive recycling lids with color-coding options ensure recyclables get into the right bins.



FUNNEL TOP LIDS

- Cut-out top enables hands-free refuse disposal
- Funnel design conceals waste from public view

NO.	COLOR	DESCRIPTION	U.S. DIMENSIONS	U.S. SHIP WT/CTN	METRIC DIMENSIONS	METRIC SHIP WT/CTN	PACK
FG260900	YEL, WHT, RED, GRAY, DGRN	Lid for 10-Gallon BRUTE® Container	15.9" dia x 1.2" h	4.7 lb	40.4 cm dia x 3.0 cm	2.1 kg	6
1779700	BLUE	Lid for 10-Gallon BRUTE® Container	15.9" dia x 1.2" h	4.7 lb	40.4 cm dia x 3.0 cm	2.1 kg	6
1926826	BLACK	Lid for 10-Gallon BRUTE® Container	15.9" dia x 1.2" h	4.7 lb	40.4 cm dia x 3.0 cm	2.1 kg	6
FG261960	YEL, WHT, RED, GRAY, BLA, DGRN	Lid for 20-Gallon BRUTE® Container	19.8" dia x 1.7" h	7.1 lb	50.5 cm dia x 4.3 cm	3.2 kg	6
1779731	BLUE	Lid for 20-Gallon BRUTE® Container	19.8" dia x 1.7" h	7.1 lb	50.5 cm dia x 4.3 cm	3.2 kg	6
FG263100	YEL, WHT, RED, GRAY, DGRN, BLUE	Lid for 32-Gallon BRUTE® Container	22.2" dia x 1.6" h	12.3 lb	56.5 cm dia x 4.1 cm	5.6 kg	6
1867532	BLACK	Executive Lid for 32-Gallon BRUTE® Container	22.2" dia x 1.6" h	12.3 lb	56.5 cm dia x 4.1 cm	5.6 kg	6
FG264560	YEL, WHT, RED, GRAY, BLA, DGRN	Lid for 44-Gallon BRUTE® Container	27.5" dia x 2.0" h	14.3 lb	69.8 cm dia x 5.0 cm	6.5 kg	4
1779636	BLUE	Lid for 44-Gallon BRUTE® Container	27.5" dia x 2.0" h	14.3 lb	69.8 cm dia x 5.0 cm	6.5 kg	4
FG265400	YEL, WHT, RED, GRAY, DGRN	Lid for 55-Gallon BRUTE® Container	29.1" dia x 3.0" h	11.6 lb	68.4 cm dia x 7.4 cm	5.3 kg	3
1779733	BLUE	Lid for 55-Gallon BRUTE® Container	29.1" dia x 3.0" h	11.6 lb	73.9 cm dia x 7.6 cm	5.3 kg	3
1779738	BLACK	Executive Lid for 55-Gallon BRUTE® Container	29.1" dia x 3.0" h	11.6 lb	73.9 cm dia x 7.6 cm	5.3 kg	3
FG263788	GRAY, RED	BRUTE® Dome Top for 32-Gallon BRUTE® Container	22.6" dia x 12.2" h	9.8 lb	57.6 cm dia x 31.1 cm	4.4 kg	1
1829398	BLUE	BRUTE® Dome Top for 32-Gallon BRUTE® Container	22.6" dia x 12.2" h	9.8 lb	57.6 cm dia x 31.1 cm	4.4 kg	1
2044152	Black	BRUTE® Dome Top for 32-Gallon BRUTE® Container	22.6" dia x 12.2" h	9.8 lb	57.6 cm dia x 31.1 cm	4.4 kg	1
FG264788	GRAY, RED	BRUTE® Dome Top for 44-Gallon BRUTE® Container	24.8" dia x 12.6" h	12.1 lb	63.0 cm dia x 32.1 cm	5.5 kg	1
1834840	BLUE	BRUTE® Dome Top for 44-Gallon BRUTE® Container	24.8" dia x 12.3" h	12.1 lb	63.0 cm dia x 32.1 cm	5.5 kg	1
2044039	Black	BRUTE® Dome Top for 44-Gallon BRUTE® Container	24.8" dia x 12.3" h	12.1 lb	63.0 cm dia x 32.1 cm	5.5 kg	1
FG265788	GRAY, RED	BRUTE® Dome Top for 55-Gallon BRUTE® Container	27.2" dia x 15.5" h	13.0 lb	69.2 cm dia x 39.3 cm	5.9 kg	1
2044151	BLUE	BRUTE® Dome Top for 55-Gallon BRUTE® Container	27.2" dia x 15.5" h	13.0 lb	69.2 cm dia x 39.3 cm	5.9 kg	1
2044040	BLACK	BRUTE® Dome Top for 55-Gallon BRUTE® Container	27.2" dia x 15.5" h	13.0 lb	69.2 cm dia x 39.3 cm	5.9 kg	1
FG354300 ¹	GRAY	Funnel Top for 32-Gallon BRUTE® Containers	22.3" dia x 5.0" h	8.8 lb	56.8 cm dia x 12.7 cm	4.0 kg	4
2017962	Red	BRUTE® 32G Lid – Open Top	24.1" dia x 5.9" h	14.3 lb	61.2 cm dim x 15.2 cm	6.5 kg	6
2017963	Yellow	BRUTE® 32G Lid – Open Top	24.1" dia x 5.9" h	14.3 lb	61.2 cm dim x 15.2 cm	6.5 kg	6
2017964	Dark Green	BRUTE® 32G Lid – Open Top	24.1" dia x 5.9" h	14.3 lb	61.2 cm dim x 15.2 cm	6.5 kg	6
2017965	Blue	BRUTE® 32G Lid – Open Top	24.1" dia x 5.9" h	14.3 lb	61.2 cm dim x 15.2 cm	6.5 kg	6
2017738	Black	BRUTE® 32G Lid – Open Top	24.1" dia x 5.9" h	14.3 lb	61.2 cm dim x 15.2 cm	6.5 kg	6
2017740	Red	BRUTE® 32G Lid – Bottles/Cans	24.1" dia x 5.9" h	14.3 lb	61.2 cm dim x 15.2 cm	6.5 kg	6
2018161	Yellow	BRUTE® 32G Lid – Bottles/Cans	24.1" dia x 5.9" h	14.3 lb	61.2 cm dim x 15.2 cm	6.5 kg	6
2018162	Dark Green	BRUTE® 32G Lid – Bottles/Cans	24.1" dia x 5.9" h	14.3 lb	61.2 cm dim x 15.2 cm	6.5 kg	6
2018163	Blue	BRUTE® 32G Lid – Bottles/Cans	24.1" dia x 5.9" h	14.3 lb	61.2 cm dim x 15.2 cm	6.5 kg	6
2018166	Red	BRUTE® 32G Lid – Paper	24.1" dia x 5.9" h	14.3 lb	61.2 cm dim x 15.2 cm	6.5 kg	6
2018167	Yellow	BRUTE® 32G Lid – Paper	24.1" dia x 5.9" h	14.3 lb	61.2 cm dim x 15.2 cm	6.5 kg	6
2018168	Dark Green	BRUTE® 32G Lid – Paper	24.1" dia x 5.9" h	14.3 lb	61.2 cm dim x 15.2 cm	6.5 kg	6
2018169	Blue	BRUTE® 32G Lid – Paper	24.1" dia x 5.9" h	14.3 lb	61.2 cm dim x 15.2 cm	6.5 kg	6
2018212	Red	BRUTE® 32G Lid – Mixed Recycling	24.1" dia x 5.9" h	14.3 lb	61.2 cm dim x 15.2 cm	6.5 kg	6
2018213	Yellow	BRUTE® 32G Lid – Mixed Recycling	24.1" dia x 5.9" h	14.3 lb	61.2 cm dim x 15.2 cm	6.5 kg	6
2018214	Dark Green	BRUTE® 32G Lid – Mixed Recycling	24.1" dia x 5.9" h	14.3 lb	61.2 cm dim x 15.2 cm	6.5 kg	6
2018215	Blue	BRUTE® 32G Lid – Mixed Recycling	24.1" dia x 5.9" h	14.3 lb	61.2 cm dim x 15.2 cm	6.5 kg	6
1788380	Blue	BRUTE® 32G Lid – Mixed Recycling	24.0" dia x 22.5" h	12.2 lb	60.9 cm dim x 57.1 cm	5.5 kg	6
1788471	Green	BRUTE® 32G Lid – Mixed Recycling	24.0" dia x 22.5" h	12.2 lb	60.9 cm dim x 57.1 cm	5.5 kg	6

¹ Provides hands-free product use.

* NSF Standard 2 and NSF Standard 21 Certification applies to BRUTE® Self-Draining Lids.



BRUTE® Dollies

Provide easy mobility and maneuverability when collecting and transporting heavy loads.



QUIET DOLLY



FG264043

TANDEM DOLLY



FG264600



NONMARKING CASTERS
Nonmarking casters on the Quiet Dolly eliminate 88% of traditional dolly noise across smooth and uneven surfaces.

TWIST LOCK
Secures your BRUTE® container to the BRUTE® Dolly.

STRUCTURAL FOAM
Provides added strength and durability.

NO.	COLOR	DESCRIPTION	U.S. DIMENSIONS	U.S. CAPACITY	U.S. SHIP WT/CTN	METRIC DIMENSIONS	METRIC CAPACITY	METRIC SHIP WT/CTN	PACK
FG264000	BLA	BRUTE® Dolly for 20-, 32-, 44-, and 55-Gallon BRUTE® Containers	18.2" dia x 6.6" h	250.0 lb	11.4 lb	46.4 cm dia x 16.8 cm	113.3 kg	5.2 kg	2
FG264043	BLA	BRUTE® Quiet Dolly for 20-, 32-, 44-, and 55-Gallon BRUTE® Containers	18.2" dia x 6.6" h	250.0 lb	10.8 lb	46.4 cm dia x 16.8 cm	113.3 kg	4.9 kg	2
FG264600	BLA	BRUTE® Tandem Dolly for 20-, 32-, 44-, and 55-Gallon BRUTE® Containers	45.0" l x 20.2" w x 8.0" h	200.0 lb per platform	19.0 lb	114.3 cm x 51.4 cm x 20.3 cm	90.7 kg per platform	8.6 kg	1
FG265000	BLA	Universal Drum Dolly for 55-Gallon BRUTE® Containers	24.4" dia x 7.1" h	500.0 lb	28.2 lb	61.9 cm dia x 18.1 cm	226.7 kg	12.8 kg	2
FG353000	BLA	BRUTE® Square Dolly for BRUTE® Square Containers	17.2" sq x 6.2" h	300.0 lb	13.5 lb	43.8 cm sq x 15.9 cm	136.07 kg	6.1 kg	2

BRUTE® Outdoor Accessories

BRUTE® Outdoor Accessories are designed to make BRUTE® containers more productive than ever.

- The BRUTE® Construction and Landscape Dolly is built to easily maneuver over rough terrain for superior handling of heavy loads.
- Built to handle rough and uneven surfaces, the BRUTE® Multi-Surface Dolly is designed to help make moving waste easier than ever.
- The BRUTE® Anchor secures BRUTE® containers to a variety of surfaces for a lifetime of use. The structural foam base fits any 20-, 32-, 44-, and 55-gallon BRUTE® container and is available in Dirt/Sand/Grass and Concrete Kits.



1997801

1997410



1997803



1997802

NO.	COLOR	DESCRIPTION	U.S. DIMENSIONS	U.S. CAPACITY	U.S. SHIP WT/CTN	METRIC DIMENSIONS	METRIC CAPACITY	METRIC SHIP WT/CTN	PACK
1997410	RED	BRUTE® Construction And Landscape Dolly	25.2" w x 52.3" h x 31.9" d	250.0 lb	28.5 lb	64.05 cm x 132.94 cm x 81.17 cm	113.3 kg	12.9 kg	1
1997801	RED	BRUTE® Multi-Surface Dolly	22.4" w x 45.6" h x 29.3" d	250.0 lb	25.1 lb	56.94 cm x 116.02 cm x 74.52 cm	113.3 kg	11.4 kg	1
1997803	BLACK	BRUTE® Anchor Kit – Concrete	18.0" dia x 2.8" h	250.0 lb	2.9 lb	45.72 cm x 7.08 cm	113.3 kg	1.3 kg	1
1997802	BLACK	BRUTE® Anchor Kit – Dirt/Grass/Sand	18.0" dia x 2.8" h	250.0 lb	4.5 lb	45.72 cm x 7.08 cm	113.3 kg	2.0 kg	1

When ordering products with **BOLD** color codes, please specify color code after the product number. Refer to the Standard Color Guide at the back of the catalog.

UTILITY REFUSE AND RECYCLING

DECORATIVE REFUSE

CLEANING

MATERIAL HANDLING

WASHROOM

FOODSERVICE

ACCESSORIES & INDEX

BRUTE® Rim Caddy

Turn your BRUTE® container into a cleaning cart with storage and transport for spray bottles, wet-floor signs, lobby dust pan, brushes, liners, gloves, and other cleaning supplies.

- Snaps securely onto the rim of BRUTE® 44-Gallon Containers
- Integrated bag straps allow for easy can liner attachment
- User-friendly handle improves maneuverability and minimizes contact with waste
- Durable construction with smooth surfaces for easy cleaning



FG9W8700



FG264900



Holds spray bottles, safety signs, and many other cleaning supplies.

Snap-on tabs keep caddy and accessories in place, even when removing a full liner.

Integrated can liner straps allow easy attachment and removal of can liners.

Efficiently dispense smaller liners from inside the BRUTE® container.

FG9W8700 Rim Caddy shown on FG264360 BRUTE® 44-Gallon Utility Container with Venting Channels, with FG264043 Quiet Dolly and other accessories sold separately.

NO.	COLOR	DESCRIPTION	U.S. DIMENSIONS	U.S. SHIP WT/CTN	METRIC DIMENSIONS	METRIC SHIP WT/CTN	PACK
FG9W8700	YEL	BRUTE® Rim Caddy for 44-Gallon Containers	32.5" l x 26.5" w x 6.75" h	4.9 lb	82.6 cm x 67.3 cm x 17.1 cm	2.2 kg	1
FG264900	GRAY	Maid Caddy	16.0" l x 9.0" w x 5.0" h	6.5 lb	40.6 cm x 22.9 cm x 12.7 cm	2.9 kg	4

BRUTE® Caddy Bag

Knock out quick cleanups on the go with onboard storage and transport for spray bottles, brushes, liners, gloves, and other supplies.

- Numerous pockets for all your cleaning supplies
- Durable vinyl material for easy cleaning



1867533



FG264200

NO.	COLOR	DESCRIPTION	U.S. DIMENSIONS	U.S. SHIP WT/CTN	METRIC DIMENSIONS	METRIC SHIP WT/CTN	PACK
FG264200	YEL	BRUTE® Caddy Bag for 32- and 44-Gallon BRUTE® Containers	20.0" dia x 20.5" h	10.7 lb	50.8 cm dia x 52.1 cm	4.8 kg	6
1867533	BLACK	Executive BRUTE® Caddy Bag for 32- and 44-Gallon BRUTE® Containers	20.0" dia x 20.5" h	10.7 lb	50.8 cm dia x 52.1 cm	4.8 kg	6

BRUTE® Square Containers

Increased capacity for storage or refuse collection.

- Square shape offers up to 14% more capacity than round containers
- Tight-fitting indented lid design helps protect dry goods and other contents, while facilitating stacking during transportation and storage
- Nesting handles allow secure fit in side-by-side use
- Gray and white are USDA Meat and Poultry Equipment Group listed and assist in complying with HACCP guidelines
- Certified to NSF Std. #2 (Red, Gray, and White) and Std. #21 (Gray and White)



FG352600



FG352900

*Not for sale in California. NSF Standard 2 Certification applies to containers and lids.

Containers and Lids

NO.	COLOR	DESCRIPTION	U.S. DIMENSIONS	U.S. CAPACITY	U.S. SHIP WT/CTN	METRIC DIMENSIONS	METRIC CAPACITY	METRIC SHIP WT/CTN	CAN LINERS	PACK
FG352600	WHT, RED, GRAY	BRUTE® Square Container without Lid	25.1" w x 22.5" h	28 gal	54.0 lb	63.8 cm x 57.2 cm	106 L	24.5 kg	5016-88*	6
FG353600	WHT, GRAY	BRUTE® Square Container without Lid	27.0" w x 28.8" h	40 gal	51.2 lb	68.6 cm x 73 cm	151.4 L	23.2 kg	5079, 5013-88*	4
FG352700	WHT, GRAY	Lid for FG352600 Container	24.3" w x 2.0" h		16.8 lb	61.6 cm x 5.1 cm		7.6 kg		6
FG353900	WHT, GRAY	Lid for FG353600 Container	26.0" sq x 2.0" h		15.3 lb	66.0 cm x 5.1 cm		6.9 kg		4
FG352900	RED	Snap-Lock® Lid for FG352600 Container	21.9" x 2.1" h		16.8 lb	55.6 cm x 5.4 cm		7.6 kg		6



UTILITY REFUSE
AND RECYCLING

DECORATIVE REFUSE

CLEANING

MATERIAL HANDLING

WASHROOM

FOODSERVICE

ACCESSORIES
& INDEX

ROLLOUT CONTAINERS



HANDS-FREE LID OPERATION

DESIGNED TO HELP PROMOTE PRODUCTIVITY With just a step, the pedal lifts the lid, eliminating the need to keep one hand free to hold the lid open.

Rollout Containers

Easy mobility for material handling, general refuse, and bulk waste collection.

- Available in 32-Gallon, 50-Gallon, 65-Gallon, and 95-Gallon capacities for improved productivity
- Heavy-duty wheels with high-performance treads are optimized for use indoors and outdoors
- Reinforced rim for superior structural integrity and robust lid designed for added strength
- Rollout lids open fully and stay in place to prevent swinging during transport
- Compliant with ANSI Standard Z245.60 (Types B and G) for compatibility with auto-lifters
- Smooth contours and seamless construction make cleaning easier and quicker, to improve staff productivity
- Designed with an ergonomic handle for comfortable push or pull operation
- High-quality materials plus a UV inhibitor extend the life of the container



1971941

FG9W2173

BRUTE® Standard Rollouts

NO.	COLOR	DESCRIPTION	U.S. DIMENSIONS	U.S. CAPACITY	U.S. SHIP WT/CTN	METRIC DIMENSIONS	METRIC CAPACITY	METRIC SHIP WT/CTN	PACK
1971941	GRAY	BRUTE® Rollout	28.6" l x 20.6" w x 37.1" h	32 gal	34.0 lb	72.5 cm x 52.4 cm x 94.4 cm	120 L	15.4 kg	2
1971943	BLUE	BRUTE® Rollout	28.6" l x 20.6" w x 37.1" h	32 gal	34.0 lb	72.5 cm x 52.4 cm x 94.4 cm	120 L	15.4 kg	2
FG9W2700	YEL	BRUTE® Rollout Container with Lid	28.5" l x 23.4" w x 36.5" h	50 gal	39.0 lb	72.4 cm x 59.4 cm x 92.7 cm	189.3 L	17.7 kg	2
FG9W2700	GRAY, BLUE	BRUTE® Rollout Container with Lid	30.1" l x 24.0" w x 39.6" h	50 gal	50.0 lb	76.4 cm x 60.9 cm x 100.5 cm	189.3 L	22.7 kg	2
1829410	WHITE	BRUTE® Rollout Container with Lid	28.5" l x 23.4" w x 36.5" h	50 gal	39.0 lb	72.4 cm x 59.4 cm x 92.7 cm	189.3 L	17.7 kg	2
1829411	GREEN	BRUTE® Rollout Container with Lid	28.5" l x 23.4" w x 36.5" h	50 gal	39.0 lb	72.4 cm x 59.4 cm x 92.7 cm	189.3 L	17.7 kg	2
FG9W2100	GRAY	BRUTE® Rollout Container with Lid	32.3" l x 25.3" w x 44.7" h	65 gal	33.5 lb	82.0 cm x 64.3 cm x 113.5 cm	246.05 L	15.2 kg	1
FG9W2173	BLUE	BRUTE® Rollout Container with Lid	32.3" l x 25.3" w x 44.7" h	65 gal	33.5 lb	82.0 cm x 64.2 cm x 113.5 cm	246.05 L	15.2 kg	1
FG9W2200	GRAY	BRUTE® Rollout Container with Lid	37.2" l x 28.6" w x 46.0" h	95 gal	38.5 lb	94.3 cm x 72.6 cm x 116.8 cm	359.6 L	17.5 kg	1
FG9W2273	BLUE	BRUTE® Rollout Container with Lid	37.2" l x 28.6" w x 46.0" h	95 gal	38.5 lb	94.3 cm x 72.6 cm x 116.8 cm	359.6 L	17.5 kg	1

BRUTE® Step-On Rollout

BRUTE® Step-On Rollouts are designed to make managing facility waste easier. With one step, the pedal lifts the lid and allows for hands-free waste disposal.



BRUTE® Step-On Rollout

NO.	COLOR	DESCRIPTION	U.S. DIMENSIONS	U.S. CAPACITY	U.S. SHIP WT/CTN	METRIC DIMENSIONS	METRIC CAPACITY	METRIC SHIP WT/CTN	PACK
1971944	GRAY	BRUTE® Step-On Rollout	28.6" l x 20.6" w x 37.2" h	32 gal	19.2 lb	72.5 cm x 52.4 cm x 94.4 cm	120 L	8.7 kg	1
1971946	BLUE	BRUTE® Step-On Rollout	28.6" l x 20.6" w x 37.2" h	32 gal	19.2 lb	72.5 cm x 52.4 cm x 94.4 cm	120 L	8.7 kg	1
1971956	GRAY	BRUTE® Step-On Rollout	30.1" l x 24.0" w x 39.6" h	50 gal	27.0 lb	76.4 cm x 60.9 cm x 100.5 cm	189 L	12.2 kg	1
1971958	BLUE	BRUTE® Step-On Rollout	30.1" l x 24.0" w x 39.6" h	50 gal	27.0 lb	76.4 cm x 60.9 cm x 100.5 cm	189 L	12.2 kg	1
1971968	GRAY	BRUTE® Step-On Rollout	32.3" l x 25.3" w x 44.7" h	65 gal	35.5 lb	82.1 cm x 64.3 cm x 113.6 cm	246 L	16.1 kg	1
1971970	BLUE	BRUTE® Step-On Rollout	32.3" l x 25.3" w x 44.7" h	65 gal	35.5 lb	82.1 cm x 64.3 cm x 113.6 cm	246 L	16.1 kg	1
1971991	GRAY	BRUTE® Step-On Rollout	37.2" l x 28.6" w x 46.0" h	95 gal	40.0 lb	94.4 cm x 72.6 cm x 116.9 cm	360 L	18.1 kg	1
1971993	BLUE	BRUTE® Step-On Rollout	37.2" l x 28.6" w x 46.0" h	95 gal	40.0 lb	94.4 cm x 72.6 cm x 116.9 cm	360 L	18.1 kg	1

BRUTE® Rollout with Casters

BRUTE® Rollouts with Casters are ideal for collecting, consolidating, and transporting heavy facility waste. Front swivel casters distribute weight evenly for superior mobility and handling.

**BRUTE® Rollout With Casters**

NO.	COLOR	DESCRIPTION	U.S. DIMENSIONS	U.S. CAPACITY	U.S. SHIP WT/CTN	METRIC DIMENSIONS	METRIC CAPACITY	METRIC SHIP WT/CTN	PACK
1971947	GRAY	BRUTE® Rollout With Casters	28.6" l x 20.6" w x 37.2" h	32 gal	42.0 lb	72.5 cm x 52.4 cm x 94.4 cm	120 L	19.1 kg	2
1971949	BLUE	BRUTE® Rollout With Casters	28.6" l x 20.6" w x 37.2" h	32 gal	42.0 lb	72.5 cm x 52.4 cm x 94.4 cm	120 L	19.1 kg	2
1971959	GRAY	BRUTE® Rollout With Casters	30.1" l x 24.0" w x 39.6" h	50 gal	58.0 lb	76.5 cm x 60.9 cm x 100.5 cm	189 L	26.3 kg	2
1971961	BLUE	BRUTE® Rollout With Casters	30.1" l x 24.0" w x 39.6" h	50 gal	58.0 lb	76.5 cm x 60.9 cm x 100.5 cm	189 L	26.3 kg	2
1971971	GRAY	BRUTE® Rollout With Casters	32.3" l x 25.3" w x 44.7" h	65 gal	36.0 lb	82.1 cm x 64.3 cm x 113.6 cm	246 L	16.3 kg	1
1971973	BLUE	BRUTE® Rollout With Casters	32.3" l x 25.3" w x 44.7" h	65 gal	36.0 lb	82.1 cm x 64.3 cm x 113.6 cm	246 L	16.3 kg	1
1971994	GRAY	BRUTE® Rollout With Casters	37.2" l x 28.6" w x 46.0" h	95 gal	44.0 lb	94.4 cm x 72.6 cm x 116.9 cm	360 L	20.0 kg	1
1971996	BLUE	BRUTE® Rollout With Casters	37.2" l x 28.6" w x 46.0" h	95 gal	44.0 lb	94.4 cm x 72.6 cm x 116.9 cm	360 L	20.0 kg	1

BRUTE® Step-On Rollout Container With Casters

BRUTE® Step-On Rollouts with Casters facilitate hands-free waste disposal with the added benefit of superior mobility. Front swivel casters distribute weight evenly for enhanced maneuverability.

**BRUTE® Step-On Rollout With Casters**

NO.	COLOR	DESCRIPTION	U.S. DIMENSIONS	U.S. CAPACITY	U.S. SHIP WT/CTN	METRIC DIMENSIONS	METRIC CAPACITY	METRIC SHIP WT/CTN	PACK
1971950	GRAY	BRUTE® Step-On Rollout With Casters	28.6" l x 20.6" w x 37.2" h	32 gal	22.2 lb	72.5 cm x 52.4 cm x 94.4 cm	120 L	10.1 kg	1
1971952	BLUE	BRUTE® Step-On Rollout With Casters	28.6" l x 20.6" w x 37.2" h	32 gal	22.2 lb	72.5 cm x 52.4 cm x 94.4 cm	120 L	10.1 kg	1
1971962	GRAY	BRUTE® Step-On Rollout With Casters	30.1" l x 24.0" w x 39.6" h	50 gal	30.0 lb	76.4 cm x 60.9 cm x 100.5 cm	189 L	13.6 kg	1
1971964	BLUE	BRUTE® Step-On Rollout With Casters	30.1" l x 24.0" w x 39.6" h	50 gal	30.0 lb	76.4 cm x 60.9 cm x 100.5 cm	189 L	13.6 kg	1
1971974	GRAY	BRUTE® Step-On Rollout With Casters	32.3" l x 25.3" w x 44.7" h	65 gal	37.0 lb	82.1 cm x 64.3 cm x 113.6 cm	246 L	16.8 kg	1
1971976	BLUE	BRUTE® Step-On Rollout With Casters	32.3" l x 25.3" w x 44.7" h	65 gal	37.0 lb	82.1 cm x 64.3 cm x 113.6 cm	246 L	16.8 kg	1
1971997	GRAY	BRUTE® Step-On Rollout With Casters	37.2" l x 28.6" w x 46.0" h	95 gal	46.0 lb	94.4 cm x 72.6 cm x 116.9 cm	360 L	20.9 kg	1
1971999	BLUE	BRUTE® Step-On Rollout With Casters	37.2" l x 28.6" w x 46.0" h	95 gal	46.0 lb	94.4 cm x 72.6 cm x 116.9 cm	360 L	20.9 kg	1



FG9W2773

FG9W1188

Recycling Rollout Containers

NO.	COLOR	DESCRIPTION	U.S. DIMENSIONS	U.S. CAPACITY	U.S. SHIP WT/CTN	METRIC DIMENSIONS	METRIC CAPACITY	METRIC SHIP WT/CTN	PACK
FG9W2773	BLUE	BRUTE® Recycling Rollout Container with Lid	28.5" l x 23.4" w x 36.5" h	50 gal	43.6 lb	72.4 cm x 59.4 cm x 92.7 cm	189.3 L	19.8 kg	2
1977788		Waste Stream Label Kit Version D fits 50-Gallon BRUTE® Rollout Containers	10.3" w x 2.6" h						1

Confidential Document Rollout Containers

NO.	COLOR	DESCRIPTION	U.S. DIMENSIONS	U.S. CAPACITY	U.S. SHIP WT/CTN	METRIC DIMENSIONS	METRIC CAPACITY	METRIC SHIP WT/CTN	PACK
FG9W1088	GRAY	BRUTE® Confidential Document Rollout Container	31.5" l x 25.3" w x 41.8" h	65 gal	31.0 lb	80.0 cm x 64.2 cm x 106.2 cm	246.05 L	14.1 kg	1
FG9W1188	GRAY	BRUTE® Confidential Document Rollout Container	35.4" l x 27.3" w x 45.6" h	95 gal	36.5 lb	89.9 cm x 69.3 cm x 115.8 cm	359.6 L	16.5 kg	1

BRUTE® Medical Waste Rollout Containers

BRUTE® Medical Waste Rollouts with Casters are designed for use in the healthcare industry. Locking lids keep regulated medical waste secure, smooth contours make cleaning easier, and front swivel casters enable balanced maneuverability.



BRUTE® Medical Waste Rollout With Casters

NO.	COLOR	DESCRIPTION	U.S. DIMENSIONS	U.S. CAPACITY	U.S. SHIP WT/CTN	METRIC DIMENSIONS	METRIC CAPACITY	METRIC SHIP WT/CTN	PACK
1971977	RED	BRUTE® Medical Waste Rollout With Casters	32.3" l x 25.3" w x 44.7" h	65 gal	36.0 lb	82.1cm x 64.3 cm x 113.6 cm	246 L	16.3 kg	1
1972000	RED	BRUTE® Medical Waste Rollout With Casters	37.2" l x 28.6" w x 46.0" h	95 gal	44.0 lb	94.3 cm x 72.6 cm x 116.8 cm	360 L	20.0 kg	1



1971977 and 1971976



SLIM JIM® CONTAINERS



80% EASIER TO LIFT LINERS

The Slim Jim® container is designed with four built-in venting channels that create airflow throughout the container. This air circulation reduces the vacuum effect that occurs when lifting out liners in traditional containers. By reducing the pull force required to lift out liners by up to 80%, the Slim Jim® container improves productivity and reduces the risk of injury.

IMPROVED PRODUCTIVITY



SlimJim

UTILITY REFUSE
AND RECYCLING



VENTING CHANNELS

Make removing liners up to 80% easier, improving productivity and reducing the risk of worker injury.



BAG CINCHES

Secure liners around the rim of the container and allow for quick, knot-free liner changes.



BASE AND RIM HANDLES

Improve grip and control while lifting and emptying full containers.



MULTIPLE DOLLY OPTIONS

Allow for efficient collection and transportation of up to four Slim Jim® containers.



DECORATIVE REFUSE

CLEANING

MATERIAL HANDLING

WASHROOM

FOODSERVICE

ACCESSORIES
& INDEX

Slim Jim® Containers with Venting Channels

Slim Jim® Containers with venting channels deliver the most efficient solution for collection, transportation, and disposal of multi-stream waste and recyclables.

- Venting channels make removing liners up to 80% easier, improving productivity and reducing the risk of worker injury*
- Four bag cinches secure liners around the rim of the container and allow for quick, knot-free liner changes
- Handles at the base and rim of the container improve grip and control while lifting and emptying full containers
- Rim with rib-strengthened design increases strength and resists crushing
- Build a recycling station with a variety of dolly and lid options to meet any facility need
- Use Waste Stream Label Kit Version E (1977789) to ensure waste sortation accuracy. See more on page 44.



1971258

FG354060GRAY



Can Liner Cinches

Four pull-through holes and can liner cinches eliminate knot tying.



1956185

1956186

1956187

1956188

1956189

FG354060BLA

FG354060BEIG

NO.	COLOR	DESCRIPTION	U.S. DIMENSIONS	U.S. CAPACITY	U.S. SHIP WT/CTN	METRIC DIMENSIONS	METRIC CAPACITY	METRIC SHIP WT/CTN	CAN LINERS	PACK
1971258	GRAY	Slim Jim® Container with Venting Channels	22.0" l x 11.0" w x 25.0" h	16 gal	26.0 lb	55.9 cm x 27.9 cm x 63.5 cm	60.6 L	11.8 kg	5009-88A	4
1971259	BEIGE	Slim Jim® Container with Venting Channels	22.0" l x 11.0" w x 25.0" h	16 gal	26.0 lb	55.9 cm x 27.9 cm x 63.5 cm	60.6 L	11.8 kg	5009-88A	4
1956181	BROWN	Slim Jim® Container with Venting Channels	22.0" l x 11.0" w x 25.0" h	16 gal	26.0 lb	55.9 cm x 27.9 cm x 63.5 cm	60.6 L	11.8 kg	5009-88A	4
1971257	BLUE	Slim Jim® Container with Venting Channels	22.0" l x 11.0" w x 25.0" h	16 gal	26.0 lb	55.9 cm x 27.9 cm x 63.5 cm	60.6 L	11.8 kg	5009-88A	4
1955960	GREEN	Slim Jim® Container with Venting Channels	22.0" l x 11.0" w x 25.0" h	16 gal	26.0 lb	55.9 cm x 27.9 cm x 63.5 cm	60.6 L	11.8 kg	5009-88A	4
1955959	BLACK	Slim Jim® Container with Venting Channels	22.0" l x 11.0" w x 25.0" h	16 gal	26.0 lb	55.9 cm x 27.9 cm x 63.5 cm	60.6 L	11.8 kg	5009-88A	4
FG354060**	GRAY, BEIG, BLA	Slim Jim® Container with Venting Channels	22.0" l x 11.0" w x 30.0" h	23 gal	31.8 lb	55.9 cm x 27.9 cm x 76.2 cm	87.1 L	14.4 kg	5009-88A	4
1956187	BROWN	Slim Jim® Container with Venting Channels	22.0" l x 11.0" w x 30.0" h	23 gal	31.8 lb	55.9 cm x 27.9 cm x 76.2 cm	87.1 L	14.4 kg	5009-88A	4
1956185	BLUE	Slim Jim® Container with Venting Channels	22.0" l x 11.0" w x 30.0" h	23 gal	31.8 lb	55.9 cm x 27.9 cm x 76.2 cm	87.1 L	14.4 kg	5009-88A	4
1956189	RED	Slim Jim® Container with Venting Channels	22.0" l x 11.0" w x 30.0" h	23 gal	31.8 lb	55.9 cm x 27.9 cm x 76.2 cm	87.1 L	14.4 kg	5009-88A	4
1956188	YELLOW	Slim Jim® Container with Venting Channels	22.0" l x 11.0" w x 30.0" h	23 gal	31.8 lb	55.9 cm x 27.9 cm x 76.2 cm	87.1 L	14.4 kg	5009-88A	4
1956186	GREEN	Slim Jim® Container with Venting Channels	22.0" l x 11.0" w x 30.0" h	23 gal	31.8 lb	55.9 cm x 27.9 cm x 76.2 cm	87.1 L	14.4 kg	5009-88A	4
FG354007	BLUE, GRN	Slim Jim® Container with Venting Channels – Recycling	22.0" l x 11.0" w x 30.0" h	23 gal	31.8 lb	55.9 cm x 27.9 cm x 76.2 cm	87.1 L	14.4 kg	5009-88A	4

*Based on internal testing.

**Custom imprinting available; contact Rubbermaid Customer Service at (800) 347-9800 for details.

UTILITY REFUSE AND RECYCLING

DECORATIVE REFUSE

CLEANING

MATERIAL HANDLING

WASHROOM

FOODSERVICE

ACCESSORIES & INDEX

Slim Jim® Accessories

Promote recycling and improve productivity.

Stainless Steel Dollies

- Collect and transport up to four streams of waste and recyclables with the new stainless steel multi-dollies for Slim Jim® containers
- Constructed from high quality stainless steel material that is easy to clean and won't rust or chip in commercial environments
- Features 3" nonmarking quiet casters that allow for smooth and quiet maneuverability
- Locking feature on casters creates a stable recycling station or collection site
- Fits both 16- and 23-gallon Slim Jim® Vented Containers

Resin Trainable Dolly

- Features a side clip-on connection that allows you to train several dollies together for collection and transportation purposes
- Foot pedal release makes disconnecting dollies quick and easy
- Structural foam construction ensures maximum durability in commercial environments
- Fits both 16- and 23-gallon Slim Jim® Vented Containers



1956192 with FG354060BLA / 1956185 / 1956186



1980602

Dollies

NO	COLOR	DESCRIPTION	U.S. DIMENSIONS	U.S. CAPACITY	U.S. SHIP WT/CTN	METRIC DIMENSIONS	METRIC CAPACITY	METRIC SHIP WT/CTN	PACK
1968468	Stainless	Slim Jim® Stainless Steel Dolly for Slim Jim® Containers – Single	20.0" l x 9.3" w x 9.0" h	100.0 lb	11.6 lb	50.8 cm x 23.6 cm x 22.9 cm	45.4 kg	5.2 kg	2
1956191	Stainless	Slim Jim® Stainless Steel Dolly for Slim Jim® Containers – Double	20.0" l x 20.6" w x 9.0" h	200.0 lb	9.9 lb	50.8 cm x 52.3 cm x 22.9 cm	90.7 kg	4.5 kg	1
1956192	Stainless	Slim Jim® Stainless Steel Dolly for Slim Jim® Containers – Triple	20.0" l x 32.5" w x 9.0" h	300.0 lb	13.6 lb	50.8 cm x 82.6 cm x 22.9 cm	136.1 kg	6.2 kg	1
1980602	Black	Slim Jim® Resin Trainable Dolly for Slim Jim® Containers	23.9" l x 14.7" w x 8.4" h	120.0 lb	11.9 lb	60.7 cm x 37.3 cm x 21.3 cm	54.4 kg	5.4 kg	2



Slim Jim® Cleaning Accessories

Slim Jim® Cleaning Accessories make mobile waste collection and cleaning in tight spaces easier than ever. Mix and match Slim Jim® cleaning accessories, containers, and dollies to suit any space.

Rim Caddy

- The Slim Jim® Rim Caddy paired with the slim profile of a Slim Jim® container allows for easy maneuvering in the tightest spaces.
- Fits securely on the rim of a Slim Jim® container, allowing for the storage and transportation of common cleaning tools. The Slim Jim® Rim Caddy features an integrated dustpan holder, dedicated hooks to hold a safety sign, and space for storing up to 3 spray bottles.
- Rim Caddies can be linked together for efficient multi-stream waste collection.
- Each Slim Jim® Rim Caddy includes a Stick Clip, Wide Hook, and Peg Hook that can be arranged into hundreds of different configurations onto five dedicated tool rails.
- Commercial-grade construction with high-quality resin material.



2032940



2032955



2032936

NO	COLOR	DESCRIPTION	PARTS INCLUDED	U.S. DIMENSIONS	U.S. SHIP WT/CTN	METRIC DIMENSIONS	METRIC SHIP WT/CTN	PACK
2032955	Yellow	Slim Jim® Rim Caddy for 23 G Containers	Rim Caddy, Stick Clip, Wide Hook, Peg Hook	32.5" l x 14.3" w x 4.8" h	5.7 lb	82.6 cm x 36.2 cm x 12.1 cm	2.6 kg	1
2032940	Black	Slim Jim® Rim Caddy for 23 G Containers	Rim Caddy, Stick Clip, Wide Hook, Peg Hook	32.5" l x 14.3" w x 4.8" h	5.7 lb	82.6 cm x 36.2 cm x 12.1 cm	2.6 kg	1
2032954	Yellow	Slim Jim® Rim Caddy Kit	Rim Caddy, Stick Clip, Wide Hook, Peg Hook, 23G Black Vented Slim Jim®, Resin Trainable Dolly	34.3" l x 14.1" w x 35.8" h	22.4 lb	87.1 cm x 35.9 cm x 90.8 cm	10.2 kg	1
2032953	Black	Slim Jim® Rim Caddy Kit	Rim Caddy, Stick Clip, Wide Hook, Peg Hook, 23G Black Vented Slim Jim® Container, Resin Trainable Dolly	34.3" l x 14.1" w x 35.8" h	22.4 lb	87.1 cm x 35.9 cm x 90.8 cm	10.2 kg	1
2032952	Yellow	Slim Jim® 2-Stream Rim Caddy Kit	(2) Rim Caddies, (2) Stick Clips, (2) Wide Hooks, (2) Peg Hooks, (2) 23G Vented Slim Jim® Containers (1 Black, 1 Blue), (2) Resin Trainable Dollies	34.3" l x 27.0" w x 35.8" h	42.6 lb	87.0 cm x 68.6 cm x 90.8 cm	19.3 kg	1
2032936	Black	Slim Jim® 2-Stream Rim Caddy Kit	(2) Rim Caddies, (2) Stick Clips, (2) Wide Hooks, (2) Peg Hooks, (2) 23G Vented Slim Jim® Containers (1 Black, 1 Blue), (2) Resin Trainable Dollies	34.3" l x 27.0" w x 35.8" h	42.6 lb	87.0 cm x 68.6 cm x 90.8 cm	19.3 kg	1

Tool Clips

- Slim Jim® Clips can be arranged into hundreds of different configurations for adaptable onboard storage.



2032938

Stick Clip:

Use the Stick Clip to store and transport brooms, dustpans, flat mops, and other long-handled tools.



2032935

Wide Hook:

Use the Wide Hook to store and transport safety signs, linen bags, and microfiber cloths.



2032937

Peg Hook:

Use the Peg Hook to store and transport dusters, scrub brushes, and other small hand tools.



2034272

PULSE™ Mop Clip:

Use the PULSE™ Mop Clip with the Rubbermaid PULSE™ Microfiber Floor Cleaning System. See more on page 83.

NO	COLOR	DESCRIPTION	PARTS INCLUDED	U.S. DIMENSIONS	U.S. SHIP WT/CTN	METRIC DIMENSIONS	METRIC SHIP WT/CTN	PACK
2032938	Gray	Slim Jim® Stick Clip for 16 and 23 G Containers	(2) Stick Clips	3.5" l x 2.5" w x 2.5" h	2.0 lb	8.9 cm x 6.4 cm x 6.4 cm	0.91 kg	6
2032935	Gray	Slim Jim® Wide Hook for 16 and 23 G Containers	(2) Wide Hooks	1.9" l x 1.9" w x 1.3" h	0.6 lb	4.8 cm x 4.8 cm x 3.3 cm	0.26 kg	6
2032937	Gray	Slim Jim® Peg Hook for 16 and 23 G Containers	(2) Peg Hooks	1.9" l x 1.9" w x 1.3" h	0.4 lb	4.8 cm x 4.8 cm x 3.3 cm	0.20 kg	6
2034272	Gray	Rubbermaid PULSE™ Mop Clip for Slim Jim® Rim Caddy	(1) PULSE™ Mop Clip	4.0" l x 5.0" w x 1.5" h	1.1 lb	10.2 cm x 12.7 cm x 3.8 cm	0.48 kg	6

Caddy Bag

- The Slim Jim® Caddy Bag maximizes space efficiency by providing onboard storage for all of the supplies needed for cleaning and liner changes on-the-go.
- The Slim Jim® Caddy Bag paired with the slim profile of a Slim Jim® container allows for easy maneuvering in the tightest spaces.
- Features 19 pockets to store and transport common cleaning tools for quick cleanups and mobile waste collection.
- Durable vinyl construction stands up to the toughest commercial environments and is easy to clean.



NO	COLOR	DESCRIPTION	PARTS INCLUDED	U.S. DIMENSIONS	U.S. SHIP WT/CTN	METRIC DIMENSIONS	METRIC SHIP WT/CTN	PACK
2032951	Yellow	Slim Jim® Caddy Bag for 23 G Containers	(1) Caddy Bag	19.0" l x 8.0" w x 3.0" h	14.75 lb	48.3 cm x 20.3 cm x 7.6 cm	6.69 kg	6
2032939	Black	Slim Jim® Caddy Bag for 23 G Containers	(1) Caddy Bag	19.0" l x 8.0" w x 3.0" h	14.75 lb	48.3 cm x 20.3 cm x 7.6 cm	6.69 kg	6

Commonly Sold With Items

EXECUTIVE 22" HYGEN™ MULTIPURPOSE FLEXIBLE MICROFIBER DUSTER AND FRAME



FGQ85200

32 OZ EXECUTIVE SPRAY BOTTLE



FG9C0306

HYGEN™ MICROFIBER BATHROOM CLOTH



FGQ61000

EXECUTIVE 16" HYGEN™ GLASS MICROFIBER CLOTH



1867398

EXECUTIVE LOBBY PRO® DUST PAN



FG253100

EXECUTIVE LOBBY BROOM WITH WOOD HANDLE



FG253600

2-SIDED FLOOR SIGN WITH MULTILINGUAL "CAUTION"



FG611200

2-SIDED EXECUTIVE MULTILINGUAL CAUTION SIGN



1867506

NO	COLOR	DESCRIPTION	U.S. DIMENSIONS	U.S. SHIP WT/CTN	METRIC DIMENSIONS	METRIC SHIP WT/CTN	PACK
FGQ85200	WHOO	Executive 22" HYGEN™ Multipurpose Flexible Microfiber Duster and Framer	28.4" l x 1.13" w x 1.13" h	5.0 lb	72.1 cm x 2.9 cm x 2.9 cm	2.3 kg	6
FG9C0306	0000	Executive Spray Bottle, 32-oz.	4.8" l x 1.3" w x 13.4" h	4.5 lb	12.2 cm x 3.3 cm x 34 cm	2.1 kg	12
FGQ61000	YLOO	HYGEN™ Microfiber Bathroom Cloth (Yellow)	16" l x 16" w	0.6 lb	40.6 cm x 40.6 cm	0.3 kg	12
1867398	GRAY	Executive 16" HYGEN™ Glass Microfiber Cloth	16" l x 16" w	1.8 lb	40.6 cm x 40.6 cm	0.8 kg	12
FG253100	BLA	Executive Lobby Pro® Dust Pan, Long Handle	12.8" l x 11.3" w x 5" h	13.0 lb	32.5 cm x 28.7 cm x 12.7 cm	5.9 kg	6
FG253600	BLA	Executive Lobby Broom w/ Wood Handle	7" l x 37.5" h	2.0 lb	17.8 cm x 95.3 cm	0.9 kg	12
FG611200	YEL	Floor Sign with Multilingual "Caution" Imprint, 2-Sided	Open: 26" l x 11" w x 25" h Closed: 26" l x 11" w	15.0 lb	Open: 66 cm x 27.9 cm x 63.5 cm Closed: 66 cm x 27.9 cm	6.8 kg	6
1867506	GRAY	Executive Multilingual Caution Sign, 2-Sided,	Open: 26" l x 11" w x 25" h Closed: 26" l x 11" w	15.0 lb	Open: 66 cm x 27.9 cm x 63.5 cm Closed: 66 cm x 27.9 cm	6.8 kg	6

Slim Jim® Recycling Lids

Intuitive recycling lids with color-coding options ensure recyclables get into the right bins.

- Lids are available with the following lid openings: Open top, Bottles/Cans, Paper, and Mixed Recycling
- Integrated billboard is sized to fit compatible waste stream labels
- Material Composition: Polypropylene
- Fits: 16 Gal and 23 Gal Slim Jim® containers
- **Use Waste Stream Label Kit Version F (2018391) to ensure waste sortation accuracy. See more on page 44.**



Open Top
2018252



Bottles/Cans
2018258



Paper
2018276



Mixed Recycling
2018302

Slim Jim® Vertical Recycling Lids

NO.	COLOR	DESCRIPTION	U.S. DIMENSIONS	U.S. SHIP WT/CTN	PACK
2018252	Blue	Slim Jim® Vertical Lid – Open Top	20.4" l x 11.5" w x 6.0" h		4
2018218	Red	Slim Jim® Vertical Lid – Open Top	20.4" l x 11.5" w x 6.0" h		4
2018219	Yellow	Slim Jim® Vertical Lid – Open Top	20.4" l x 11.5" w x 6.0" h		4
2018220	Green	Slim Jim® Vertical Lid – Open Top	20.4" l x 11.5" w x 6.0" h		4
2018253	Black	Slim Jim® Vertical Lid – Open Top	20.4" l x 11.5" w x 6.0" h		4
2018254	Brown	Slim Jim® Vertical Lid – Open Top	20.4" l x 11.5" w x 6.0" h		4
2018258	Blue	Slim Jim® Vertical Lid – Bottles/Cans	20.4" l x 11.5" w x 6.0" h		4
2018255	Red	Slim Jim® Vertical Lid – Bottles/Cans	20.4" l x 11.5" w x 6.0" h		4
2018256	Yellow	Slim Jim® Vertical Lid – Bottles/Cans	20.4" l x 11.5" w x 6.0" h		4
2018257	Green	Slim Jim® Vertical Lid – Bottles/Cans	20.4" l x 11.5" w x 6.0" h		4
2018260	Brown	Slim Jim® Vertical Lid – Bottles/Cans	20.4" l x 11.5" w x 6.0" h		4
2018276	Blue	Slim Jim® Vertical Lid – Paper	20.4" l x 11.5" w x 6.0" h		4
2018272	Red	Slim Jim® Vertical Lid – Paper	20.4" l x 11.5" w x 6.0" h		4
2018274	Yellow	Slim Jim® Vertical Lid – Paper	20.4" l x 11.5" w x 6.0" h		4
2018275	Green	Slim Jim® Vertical Lid – Paper	20.4" l x 11.5" w x 6.0" h		4
2018278	Brown	Slim Jim® Vertical Lid – Paper	20.4" l x 11.5" w x 6.0" h		4
2018302	Blue	Slim Jim® Vertical Lid – Mixed Recycling	20.4" l x 11.5" w x 6.0" h		4
2018279	Red	Slim Jim® Vertical Lid – Mixed Recycling	20.4" l x 11.5" w x 6.0" h		4
2018280	Yellow	Slim Jim® Vertical Lid – Mixed Recycling	20.4" l x 11.5" w x 6.0" h		4
2018301	Green	Slim Jim® Vertical Lid – Mixed Recycling	20.4" l x 11.5" w x 6.0" h		4
2018304	Brown	Slim Jim® Vertical Lid – Mixed Recycling	20.4" l x 11.5" w x 6.0" h		4

Slim Jim® Lids

- Encourage waste separation and recycling with interchangeable, color-coded lids
- Swing Lid conceals waste from view and provides no-touch access
- Hinged Lid folds flat while in use and completely covers waste when closed; complies with Health and Human Services Standard



Handle Top Lid
FG268888GRAY



Bottles and Cans Lid
FG269288BLUE



Swing Lid
FG267360GRAY



Hinged Lid
FG267400BLA

NO.	COLOR	DESCRIPTION	U.S. DIMENSIONS	U.S. SHIP WT/CTN	PACK
FG268888L	GRAY	Slim Jim® Handle Top	20.4" l x 11.2" w x 3.8" h	4.1 lb	4
FG267360	BEIG, BLA, BLUE, GRAY	Slim Jim® Swing Lid for Slim Jim® Containers	20.5" l x 11.7" w x 5.0" h	12.5 lb	4
1829400	GREEN	Slim Jim® Swing Lid for Slim Jim® Containers	20.5" l x 11.4" w x 5.0" h	12.5 lb	4
FG269288	BLUE, BRN, GRN, RED, YEL	Slim Jim® Bottles and Cans Recycling Lid for Slim Jim® Containers	20.4" l x 11.3" w x 2.8" h	3.9 lb	4
FG270388	BLUE, GRN	Slim Jim® Paper Recycling Lid for Slim Jim® Containers	20.5" l x 11.5" w x 2.8" h	4.1 lb	4
1788372	BLUE	Slim Jim® Mixed Recycling Lid for Slim Jim® Containers	21.1" l x 12.1" w x 2.8" h	5.4 lb	4
1788373	GRN	Slim Jim® Recycling Mixed Lid Green	20.5" l x 11.5" w x 2.8" h	4.1 lb	4
FG267400	BLA	Executive Slim Jim® Hinged Lid for Slim Jim® Containers	21.0" l x 13.5" w x 1.2" h	6.5 lb	4
FG9W1600L	GRAY	Slim Jim® Confidential Document Lid	20.4" l x 11.4" w x 2.1" h		4



956185/2018276, 1955959/2018253

www.rubbermaidcommercial.com



UTILITY REFUSE
AND RECYCLING

DECORATIVE REFUSE

CLEANING

MATERIAL HANDLING

WASHROOM

FOODSERVICE

ACCESSORIES
& INDEX

AN ADAPTABLE

RECYCLING SOLUTION

Customized recycling—Facilities can choose from 7 colors and 4 lid openings to customize a recycling station that fits their unique recycling needs.





7 COLORS

Color-coding creates consistent visual cues for patrons and staff when sorting recyclables.



4 LID OPTIONS

Restrictive lid shapes ensure the right recyclables get into the right bins. For an open top option, no insert needed.



Mixed Recycling Paper Bottles / Cans Closed



10 WASTE STREAM LABELS

Expert designed waste stream labels feature 3 visual cues: the recycling symbol, a waste stream icon, and verbiage proven to increase recycling effectiveness.



Slim Jim® Recycling Station

Select a pre-made kit (Option 1) or create your own station (Option 2) by selecting from the offerings of lid inserts, billboards, and waste stream labels, in combination with a starter kit.

Slim Jim® Recycling Station – Pre-Made Kits (Option 1)

Select from a variety of pre-determined multi-stream stations to fit your unique recycling need.

- Intuitive lid openings help patrons and staff sort recyclables more effectively
- Provide better waste stream visibility by selecting a color and waste stream label for your facility needs
- Hinging lid inserts are optimized to fit any size recyclable
- Simple and durable execution. Components snap in place without the use of hardware
- Waste Stream Label Kit is included in Recycling Kit



2007919

NO.	COLOR	DESCRIPTION	U.S. DIMENSIONS	U.S. CAPACITY	U.S. SHIP WT/CTN	METRIC DIMENSIONS	METRIC SHIP WT/CTN	PACK
2007914	Black/Blue	2-Stream Station Landfill/Mixed Recycling	21.5" l x 24.0" w x 40.3" h	23 gal/23 gal	12.5 lb	54.6 cm x 60.9 cm x 102.25 cm	5.6 kg	1
2007915	Black/Blue	2-Stream Station Landfill/Paper	21.5" l x 24.0" w x 40.3" h	23 gal/23 gal	24.0 lb	54.6 cm x 60.9 cm x 102.25 cm	10.9 kg	1
2007916	Black/Yellow	2-Stream Station Landfill/Bottles/Cans	21.5" l x 24.0" w x 40.3" h	23 gal/23 gal	24.0 lb	54.6 cm x 60.9 cm x 102.25 cm	10.9 kg	1
2007917	Black/Blue/Yellow	3-Stream Station Landfill/Paper/Bottles/Cans	21.5" l x 36.0" w x 40.3" h	23 gal/23 gal/23 gal	37.1 lb	54.6 cm x 91.4 cm x 102.25 cm	16.8 kg	1
2007918	Black/Blue/Green	3-Stream Station Landfill/Mixed Recycling/Compost	21.5" l x 36.0" w x 40.3" h	23 gal/23 gal/23 gal	37.1 lb	54.6 cm x 91.4 cm x 102.25 cm	16.8 kg	1
2007919	Black/Blue/Red/Yellow	4-Stream Station Landfill/Paper/Plastic/Cans	21.5" l x 48.0" w x 40.3" h	23 gal/23 gal/23 gal/23 gal	47.3 lb	54.6 cm x 121.9 cm x 102.25 cm	21.5 kg	1

Slim Jim® Recycling Station – Create Your Own Station (Option 2)

An adaptable recycling solution offers a front-of-house look with back-of-house functionality.

- Starter Kit includes a base, lid, and connector. Lid Inserts and Billboards sold separately.
- You will need as many starter kits as streams you want in your station.
- Intuitive lid openings help patrons and staff sort recyclables more effectively.
- Provide better waste stream visibility by selecting a color and waste stream label for your facility needs.
- Hinging lid inserts are optimized to fit any size recyclable.
- Simple and durable execution. Components snap in place without the use of hardware.



2007913



1

▶ SELECT A STARTER KIT

Build your own station by selecting the starter kit: A Base, Lid, and Connector.



2

▶ CHOOSE A LID INSERT

Choose your color and opening type: Mixed Recycle, Paper, Bottles/Cans, and Closed.

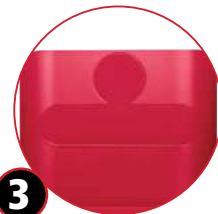

3

▶ COORDINATE THE BILLBOARD

Choose the color to match your lid inserts: Blue, Red, Yellow, Green, Brown, Dark Gray, and Black.



4

▶ ADD A WASTE STREAM LABEL

Choose from ten waste stream labels to complete the station.

Slim Jim® Recycling Station – Starter Kit

NO.	COLOR	DESCRIPTION	U.S. DIMENSIONS	U.S. CAPACITY	U.S. SHIP WT/CTN	METRIC DIMENSIONS	METRIC SHIP WT/CTN	PACK
2007913	Light Gray	Starter Kit	21.5" l x 12.0" w x 34.3" h	23 gal	11.8 lb	54.6 cm x 30.5 cm x 87.05 cm	5.4 kg	1

When ordering products with **BOLD** color codes, please specify color code after the product number. Refer to the Standard Color Guide at the back of the catalog.

UTILITY REFUSE AND RECYCLING

DECORATIVE REFUSE

CLEANING

MATERIAL HANDLING

WASHROOM

FOODSERVICE

ACCESSORIES & INDEX

Slim Jim® Recycling Station – Lid Inserts

- Intuitive lid openings help patrons and staff sort recyclables more effectively.
- Hinging lid inserts are optimized to fit any size recyclable
- Components snap in place without the use of hardware
- Compatible with Slim Jim® Recycling Station Starter Kit



NO.	COLOR	DESCRIPTION	U.S. SHIP WT/CTN	U.S. DIMENSIONS	METRIC SHIP WT/CTN	PACK
2007192	Red	Closed Lid Insert	0.8 lb	16.5" l x 8.0" w x 0.5" h	0.3 kg	1
2007193	Red	Bottles/Cans Lid Insert	0.8 lb	16.5" l x 8.0" w x 0.5" h	0.3 kg	1
2007194	Red	Paper Slot Lid Insert	0.8 lb	16.5" l x 8.0" w x 0.5" h	0.3 kg	1
2007195	Red	Mixed Recycling Lid Insert	0.8 lb	16.5" l x 8.0" w x 0.5" h	0.3 kg	1
2007200	Yellow	Closed Lid Insert	0.8 lb	16.5" l x 8.0" w x 0.5" h	0.3 kg	1
2007881	Yellow	Bottles/Cans Lid Insert	0.8 lb	16.5" l x 8.0" w x 0.5" h	0.3 kg	1
2007882	Yellow	Paper Slot Lid Insert	0.8 lb	16.5" l x 8.0" w x 0.5" h	0.3 kg	1
2007883	Yellow	Mixed Recycling Lid Insert	0.8 lb	16.5" l x 8.0" w x 0.5" h	0.3 kg	1
2007884	Green	Closed Lid Insert	0.8 lb	16.5" l x 8.0" w x 0.5" h	0.3 kg	1
2007885	Green	Bottles/Cans Lid Insert	0.8 lb	16.5" l x 8.0" w x 0.5" h	0.3 kg	1
2007886	Green	Paper Slot Lid Insert	0.8 lb	16.5" l x 8.0" w x 0.5" h	0.3 kg	1
2007887	Green	Mixed Recycling Lid Insert	0.8 lb	16.5" l x 8.0" w x 0.5" h	0.3 kg	1
2007888	Blue	Closed Lid Insert	0.8 lb	16.5" l x 8.0" w x 0.5" h	0.3 kg	1
2007889	Blue	Bottles/Cans Lid Insert	0.8 lb	16.5" l x 8.0" w x 0.5" h	0.3 kg	1
2007890	Blue	Paper Slot Lid Insert	0.8 lb	16.5" l x 8.0" w x 0.5" h	0.3 kg	1
2007891	Blue	Mixed Recycling Lid Insert	0.8 lb	16.5" l x 8.0" w x 0.5" h	0.3 kg	1
2007892	Black	Closed Lid Insert	0.8 lb	16.5" l x 8.0" w x 0.5" h	0.3 kg	1
2007893	Black	Bottles/Cans Lid Insert	0.8 lb	16.5" l x 8.0" w x 0.5" h	0.3 kg	1
2007894	Black	Paper Slot Lid Insert	0.8 lb	16.5" l x 8.0" w x 0.5" h	0.3 kg	1
2007895	Black	Mixed Recycling Lid Insert	0.8 lb	16.5" l x 8.0" w x 0.5" h	0.3 kg	1
2007896	Dark Gray	Closed Lid Insert	0.8 lb	16.5" l x 8.0" w x 0.5" h	0.3 kg	1
2007897	Dark Gray	Bottles/Cans Lid Insert	0.8 lb	16.5" l x 8.0" w x 0.5" h	0.3 kg	1
2007898	Dark Gray	Paper Slot Lid Insert	0.8 lb	16.5" l x 8.0" w x 0.5" h	0.3 kg	1
2007899	Dark Gray	Mixed Recycling Lid Insert	0.8 lb	16.5" l x 8.0" w x 0.5" h	0.3 kg	1
2007900	Brown	Closed Lid Insert	0.8 lb	16.5" l x 8.0" w x 0.5" h	0.3 kg	1
2007902	Brown	Bottles/Cans Lid Insert	0.8 lb	16.5" l x 8.0" w x 0.5" h	0.3 kg	1
2007903	Brown	Paper Slot Lid Insert	0.8 lb	16.5" l x 8.0" w x 0.5" h	0.3 kg	1
2007904	Brown	Mixed Recycling Lid Insert	0.8 lb	16.5" l x 8.0" w x 0.5" h	0.3 kg	1

Slim Jim® Recycling Station – Billboard

- Provide better waste stream visibility by selecting a color and waste stream label for your facility needs
- Components snap in place without the use of hardware
- Compatible with Slim Jim® Recycling Station Starter Kit, Slim Jim® Recycling Station lid inserts, and Slim Jim® Recycling Station Waste Stream label kits

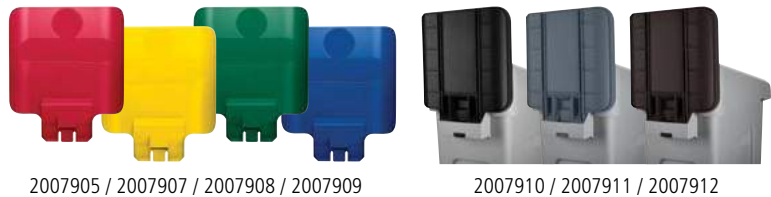

NO.	COLOR	DESCRIPTION	U.S. DIMENSIONS	U.S. SHIP WT/CTN	METRIC SHIP WT/CTN	PACK
2007905	Red	Billboard	1.75" l x 11.75" w x 14.25" h	0.9 lb	0.9 lb	1
2007907	Yellow	Billboard	1.75" l x 11.75" w x 14.25" h	0.9 lb	0.9 lb	1
2007908	Green	Billboard	1.75" l x 11.75" w x 14.25" h	0.9 lb	0.9 lb	1
2007909	Blue	Billboard	1.75" l x 11.75" w x 14.25" h	0.9 lb	0.9 lb	1
2007910	Black	Billboard	1.75" l x 11.75" w x 14.25" h	0.9 lb	0.9 lb	1
2007911	Dark Gray	Billboard	1.75" l x 11.75" w x 14.25" h	0.9 lb	0.9 lb	1
2007912	Brown	Billboard	1.75" l x 11.75" w x 14.25" h	0.9 lb	0.9 lb	1

Slim Jim® Recycling Station – Waste Stream Label Kits

- Kit contains 10 different waste stream labels.

NO.	COLOR	DESCRIPTION	U.S. DIMENSIONS	U.S. SHIP WT/CTN	METRIC DIMENSIONS	METRIC SHIP WT/CTN	PACK
1977787	White	Label Kit: English (United States)	9.5" w x 5.7" h	0.15 lb	24.1 cm x 14.5 cm	0.07 kg	1
2007922	White	Label Kit: French/English (Canada)	9.5" w x 5.7" h	0.15 lb	24.1 cm x 14.5 cm	0.07 kg	1
2007921	White	Label Kit: English (United Kingdom)	9.5" w x 5.7" h	0.15 lb	24.1 cm x 14.5 cm	0.07 kg	1
2007924	White	Label Kit: English (Australia)	9.5" w x 5.7" h	0.15 lb	24.1 cm x 14.5 cm	0.07 kg	1
2007923	White	Label Kit: Spanish	9.5" w x 5.7" h	0.15 lb	24.1 cm x 14.5 cm	0.07 kg	1
2007920	White	Label Kit: Chinese/English	9.5" w x 5.7" h	0.15 lb	24.1 cm x 14.5 cm	0.07 kg	1

UTILITY REFUSE
AND RECYCLING

DECORATIVE REFUSE

CLEANING

MATERIAL HANDLING

WASHROOM

FOODSERVICE

ACCESSORIES
& INDEX



**A NEW ANGLE
ON ACCESS**

2026699, 2026721

When ordering products with **BOLD** color codes, please specify color code after the product number. Refer to the Standard Color Guide at the back of the catalog.

Slim Jim® Under-Counter Containers

A purpose-built solution for space efficient waste disposal under the counter.

- Large angled opening provides 2X more access under the counter than traditional slim containers.
- Integrated venting channels make removing liners 80% easier, improving productivity and reducing the risk of worker injury.
- Commercial-grade construction with high-quality resin material.
- Bag cinches secure liners around the rim of the container and allow for quick, knot-free liner changes.
- Rim and base handles improve grip and control while lifting and emptying full containers.
- Reinforced rim maintains structural integrity to resist crushing.
- Available in 6 colors, Slim Jim® Under-Counter containers fit any space or need.
- Recycling label kit includes seven intuitive waste stream decals, encouraging waste sortation accuracy.
- Recycling label kit includes seven intuitive waste stream decals, encouraging waste sortation accuracy.
- Use Waste Stream Label Kit Version E (1977789) to ensure waste sortation accuracy. See more on page 46.



2026695



2026698



2026699



2026700



2026696



2026697

NO.	COLOR	DESCRIPTION	U.S. DIMENSIONS	U.S. CAPACITY	U.S. SHIP WT/CTN	METRIC DIMENSIONS	METRIC CAPACITY	METRIC SHIP WT/CTN	CAN LINERS	PACK
2026695	Gray	Slim Jim® Under-Counter Container	22.2" l x 11.2" w x 26.1" h	13 gal	30.7 lb	56.5 cm x 28.4 cm x 66.3 cm	49 L	13.9 kg	FG500788	4
2026696	Black	Slim Jim® Under-Counter Container	22.2" l x 11.2" w x 26.1" h	13 gal	30.7 lb	56.5 cm x 28.4 cm x 66.3 cm	49 L	13.9 kg	FG500788	4
2026697	Brown	Slim Jim® Under-Counter Container	22.2" l x 11.2" w x 26.1" h	13 gal	30.7 lb	56.5 cm x 28.4 cm x 66.3 cm	49 L	13.9 kg	FG500788	4
2026698	Beige	Slim Jim® Under-Counter Container	22.2" l x 11.2" w x 26.1" h	13 gal	30.7 lb	56.5 cm x 28.4 cm x 66.3 cm	49 L	13.9 kg	FG500788	4
2026699	Blue	Slim Jim® Under-Counter Container	22.2" l x 11.2" w x 26.1" h	13 gal	30.7 lb	56.5 cm x 28.4 cm x 66.3 cm	49 L	13.9 kg	FG500788	4
2026700	Green	Slim Jim® Under-Counter Container	22.2" l x 11.2" w x 26.1" h	13 gal	30.7 lb	56.5 cm x 28.4 cm x 66.3 cm	49 L	13.9 kg	FG500788	4
2026721	Gray	Slim Jim® Under-Counter Container	22.1" l x 15.8" w x 30.0" h	23 gal	41.7 lb	56.0 cm x 40.12 cm x 76.2 cm	87 L	18.9 kg	FG501188	4
2026722	Black	Slim Jim® Under-Counter Container	22.1" l x 15.8" w x 30.0" h	23 gal	41.7 lb	56.0 cm x 40.12 cm x 76.2 cm	87 L	18.9 kg	FG501188	4
2026723	Brown	Slim Jim® Under-Counter Container	22.1" l x 15.8" w x 30.0" h	23 gal	41.7 lb	56.0 cm x 40.12 cm x 76.2 cm	87 L	18.9 kg	FG501188	4
2026724	Beige	Slim Jim® Under-Counter Container	22.1" l x 15.8" w x 30.0" h	23 gal	41.7 lb	56.0 cm x 40.12 cm x 76.2 cm	87 L	18.9 kg	FG501188	4
2026725	Blue	Slim Jim® Under-Counter Container	22.1" l x 15.8" w x 30.0" h	23 gal	41.7 lb	56.0 cm x 40.12 cm x 76.2 cm	87 L	18.9 kg	FG501188	4
2026726	Green	Slim Jim® Under-Counter Container	22.1" l x 15.8" w x 30.0" h	23 gal	41.7 lb	56.0 cm x 40.12 cm x 76.2 cm	87 L	18.9 kg	FG501188	4

Stainless Steel Dollies

- Collect and transport up to four streams of waste and recyclables with the new stainless steel multi-dollies for Slim Jim® containers
- Constructed from high quality stainless steel material that is easy to clean and won't rust or chip in commercial environments
- Features 3" nonmarking quiet casters that allow for smooth and quiet maneuverability
- Locking feature on casters creates a stable recycling station or collection site
- Slim Jim® Dollies are only compatible with 13G Slim Jim® Under-Counter Containers.



1956192 with 2026699 / 2026700 / 2026696



1980602

Resin Trainable Dolly

- Features a side clip-on connection that allows you to train several dollies together for collection and transportation purposes
- Foot pedal release makes disconnecting dollies quick and easy
- Structural foam construction ensures maximum durability in commercial environments
- Slim Jim® Dollies are only compatible with 13G Slim Jim® Under-Counter Containers.

Dollies

NO	COLOR	DESCRIPTION	U.S. DIMENSIONS	U.S. CAPACITY	U.S. SHIP WT/CTN	METRIC DIMENSIONS	METRIC CAPACITY	METRIC SHIP WT/CTN	PACK
1968468	Stainless	Slim Jim® Stainless Steel Dolly for Slim Jim® Containers – Single	20.0" l x 9.3" w x 9.0" h	100.0 lb	11.6 lb	50.8 cm x 23.6 cm x 22.9 cm	45.4 kg	5.2 kg	2
1956191	Stainless	Slim Jim® Stainless Steel Dolly for Slim Jim® Containers – Double	20.0" l x 20.6" w x 9.0" h	200.0 lb	9.9 lb	50.8 cm x 52.3 cm x 22.9 cm	90.7 kg	4.5 kg	1
1956192	Stainless	Slim Jim® Stainless Steel Dolly for Slim Jim® Containers – Triple	20.0" l x 32.5" w x 9.0" h	300.0 lb	13.6 lb	50.8 cm x 82.6 cm x 22.9 cm	136.1 kg	6.2 kg	1
1980602	Black	Slim Jim® Resin Trainable Dolly for Slim Jim® Containers	23.9" l x 14.7" w x 8.4" h	120.0 lb	11.9 lb	60.7 cm x 37.3 cm x 21.3 cm	54.4 kg	5.4 kg	2



SLIM JIM® STEP-ON CONTAINERS

SlimJim®



QUIET AND CONTROLLED LID CLOSURE

Minimizes noise to enhance guest and patient satisfaction.



SELF-EXTINGUISHING

To ensure fire safety and comply with Factory Mutual (FM) regulations.



MEETS OSHA AND OBRA STANDARDS

For worker and environmental safety.



FITS IN THE TIGHTEST SPACES

Resin Slim Jim® Step-On Containers

Slim profile and small footprint maximize space to fit in the tightest spaces.

- Commercial-grade pedal tested to 300,000 cycles to ensure life in heavy-use environments*
- Robust lid structure features a rigid arch design to prevent warping
- Stainless steel components resist corrosion for long-lasting, smooth operation
- Liner retainer band and cinch easily and securely holds polyliners
- Optional dual-stream rigid liner simplifies sorting, making recycling quick and easy
- Increased foot pedal clearance for easier access and operation
- Quiet and controlled lid closure minimizes noise to enhance guest and patient satisfaction
- Self-extinguishing to ensure fire safety and comply with Factory Manual (FM) regulations
- Meets OSHA and OBRA standards for worker and environmental safety



OSHA OBRA



Resin Step-On Containers

NO.	COLOR	DESCRIPTION	U.S. DIMENSIONS	U.S. CAPACITY	U.S. SHIP WT/CTN	METRIC DIMENSIONS	METRIC CAPACITY	METRIC SHIP WT/CTN	CAN LINERS	PACK
1883455	BEIGE	Resin Front Step	14.8" l x 9.1" w x 15.7" h	4 gal	4.70 lb	377 mm x 230 mm x 399 mm	15 L	2.136 kg		1
1883554	WHITE	Resin Front Step	14.8" l x 9.1" w x 15.7" h	4 gal	4.70 lb	377 mm x 230 mm x 399 mm	15 L	2.136 kg		1
1883563	RED	Resin Front Step	14.8" l x 9.1" w x 15.7" h	4 gal	4.70 lb	377 mm x 230 mm x 399 mm	15 L	2.136 kg		1
1883599	GRAY	Resin Front Step	14.8" l x 9.1" w x 15.7" h	4 gal	4.70 lb	377 mm x 230 mm x 399 mm	15 L	2.136 kg		1
1883608	BLACK	Resin Front Step	14.8" l x 9.1" w x 15.7" h	4 gal	4.70 lb	377 mm x 230 mm x 399 mm	15 L	2.136 kg		1
1883456	BEIGE	Resin Front Step	16.7" l x 10.6" w x 21.1" h	8 gal	6.0 lb	425 mm x 271 mm x 536 mm	30 L	2.727 kg		1
1883555	WHITE	Resin Front Step	16.7" l x 10.6" w x 21.1" h	8 gal	6.0 lb	425 mm x 271 mm x 536 mm	30 L	2.727 kg		1
1883564	RED	Resin Front Step	16.7" l x 10.6" w x 21.1" h	8 gal	6.0 lb	425 mm x 271 mm x 536 mm	30 L	2.727 kg		1
1883600	GRAY	Resin Front Step	16.7" l x 10.6" w x 21.1" h	8 gal	6.0 lb	425 mm x 271 mm x 536 mm	30 L	2.727 kg		1
1883609	BLACK	Resin Front Step	16.7" l x 10.6" w x 21.1" h	8 gal	6.0 lb	425 mm x 271 mm x 536 mm	30 L	2.727 kg		1
1883457	BEIGE	Resin End Step	19.6" l x 12.3" w x 22.3" h	8 gal	10.7 lb	497 mm x 311 mm x 566 mm	30 L	4.864 kg	1	1
1883565	RED	Resin End Step	19.6" l x 12.3" w x 22.3" h	8 gal	10.7 lb	497 mm x 311 mm x 566 mm	30 L	4.864 kg	1	1
1883610	BLACK	Resin End Step	19.6" l x 12.3" w x 22.3" h	8 gal	10.7 lb	497 mm x 311 mm x 566 mm	30 L	4.864 kg	1	1
1883458	BEIGE	Resin Front Step	17.9" l x 11.5" w x 28.3" h	13 gal	8.5 lb	456 mm x 292 mm x 719 mm	50 L	3.864 kg		1
1883557	WHITE	Resin Front Step	17.9" l x 11.5" w x 28.3" h	13 gal	8.5 lb	456 mm x 292 mm x 719 mm	50 L	3.864 kg		1
1883566	RED	Resin Front Step	17.9" l x 11.5" w x 28.3" h	13 gal	8.5 lb	456 mm x 292 mm x 719 mm	50 L	3.864 kg		1
1883593	BLUE	Resin Front Step	17.9" l x 11.5" w x 28.3" h	13 gal	8.5 lb	456 mm x 292 mm x 719 mm	50 L	3.864 kg		1
1883602	GRAY	Resin Front Step	17.9" l x 11.5" w x 28.3" h	13 gal	8.5 lb	456 mm x 292 mm x 719 mm	50 L	3.864 kg		1
1883611	BLACK	Resin Front Step	17.9" l x 11.5" w x 28.3" h	13 gal	8.5 lb	456 mm x 292 mm x 719 mm	50 L	3.864 kg		1
1883459	BEIGE	Resin End Step	20.8" l x 13.5" w x 28.4" h	13 gal	15.6 lb	527 mm x 343 mm x 721 mm	50 L	7.091 kg	1	1
1883612	BLACK	Resin End Step	20.8" l x 13.5" w x 28.4" h	13 gal	15.6 lb	527 mm x 343 mm x 721 mm	50 L	7.091 kg	1	1
1883460	BEIGE	Resin Front Step	19.7" l x 12.2" w x 31.6" h	18 gal	11.5 lb	500 mm x 311 mm x 803 mm	68 L	5.227 kg		1
1883559	WHITE	Resin Front Step	19.7" l x 12.2" w x 31.6" h	18 gal	11.5 lb	500 mm x 311 mm x 803 mm	68 L	5.227 kg		1
1883568	RED	Resin Front Step	19.7" l x 12.2" w x 31.6" h	18 gal	11.5 lb	500 mm x 311 mm x 803 mm	68 L	5.227 kg		1
1883604	GRAY	Resin Front Step	19.7" l x 12.2" w x 31.6" h	18 gal	11.5 lb	500 mm x 311 mm x 803 mm	68 L	5.227 kg		1
1883613	BLACK	Resin Front Step	19.7" l x 12.2" w x 31.6" h	18 gal	11.5 lb	500 mm x 311 mm x 803 mm	68 L	5.227 kg		1
1883551	BEIGE	Resin End Step	22.1" l x 14.7" w x 30.8" h	18 gal	17.1 lb	562 mm x 373 mm x 781 mm	68 L	7.773 kg	1	1
1883614	BLACK	Resin End Step	22.1" l x 14.7" w x 30.8" h	18 gal	17.1 lb	562 mm x 373 mm x 781 mm	68 L	7.773 kg	1	1
1883552	BEIGE	Resin Front Step	22.4" l x 13.9" w x 32.5" h	24 gal	13.4 lb	570 mm x 353 mm x 826 mm	90 L	6.091 kg		1
1883561	WHITE	Resin Front Step	22.4" l x 13.9" w x 32.5" h	24 gal	13.4 lb	570 mm x 353 mm x 826 mm	90 L	6.091 kg		1
1883570	RED	Resin Front Step	22.4" l x 13.9" w x 32.5" h	24 gal	13.4 lb	570 mm x 353 mm x 826 mm	90 L	6.091 kg		1
1883597	BLUE	Resin Front Step	22.4" l x 13.9" w x 32.5" h	24 gal	13.4 lb	570 mm x 353 mm x 826 mm	90 L	6.091 kg		1
1883606	GRAY	Resin Front Step	22.4" l x 13.9" w x 32.5" h	24 gal	13.4 lb	570 mm x 353 mm x 826 mm	90 L	6.091 kg		1
1883615	BLACK	Resin Front Step	22.4" l x 13.9" w x 32.5" h	24 gal	13.4 lb	570 mm x 353 mm x 826 mm	90 L	6.091 kg		1
1883553	BEIGE	Resin End Step	25.1" l x 15.9" w x 32.0" h	24 gal	21.1 lb	637 mm x 403 mm x 813 mm	90 L	9.591 kg	1	1
1883616	BLACK	Resin End Step	25.1" l x 15.9" w x 32.0" h	24 gal	21.1 lb	637 mm x 403 mm x 813 mm	90 L	9.591 kg	1	1

*Based on internal testing



Rigid Liner for Resin Slim Jim®

NO.	COLOR	DESCRIPTION	U.S. DIMENSIONS	U.S. CAPACITY	U.S. SHIP WT/CTN	METRIC DIMENSIONS	METRIC CAPACITY	METRIC SHIP WT/CTN	PACK
1883617		Slim Jim® Rigid Liner for 50L/13G Resin FS	12.8" l x 7.4" w x 12.8" h	3 gal	1.6 lb	325 mm x 189 mm x 324 mm	11 L	2.0 kg	1
1883618		Slim Jim® Rigid Liner for 30L/8G Resin FS	14.8" l x 9.1" w x 18.1" h	6 gal	2.8 lb	376 mm x 230 mm x 460 mm	24 L	1.2 kg	1
1883619		Slim Jim® Rigid Liner for 50L/13G Resin FS	15.8" l x 9.8" w x 18.1" h	10.5 gal	4.4 lb	402 mm x 249 mm x 646 mm	41 L	2.0 kg	1
1883620		Slim Jim® Rigid Liner for 68L/18G Resin FS	17.8" l x 10.2" w x 28.3" h	15 gal	5.4 lb	451 mm x 259 mm x 718 mm	57 L	2.5 kg	1
1883621		Slim Jim® Rigid Liner for 90L/24G Resin FS	20.3" l x 11.8" w x 29.5" h	20 gal	6.2 lb	516 mm x 300 mm x 749 mm	77.5 L	2.8 kg	1
1883623		Slim Jim® Rigid Liner for 30L/8G Resin ES	16.5" l x 8.7" w x 19.5" h	7.5 gal	3.2 lb	419 mm x 221 mm x 495 mm	30 L	1.5 kg	1
1883624		Slim Jim® Rigid Liner for 50L/13G Resin ES	17.8" l x 9.9" w x 25.5" h	13 gal	4.6 lb	451 mm x 252 mm x 648 mm	50 L	2.1 kg	1
1883625		Slim Jim® Rigid Liner for 68L/18G Resin ES	19.2" l x 11.1" w x 28.0" h	17.5 gal	5.6 lb	487 mm x 283 mm x 711 mm	68 L	2.5 kg	1
1883626		Slim Jim® Rigid Liner for 90L/24G Resin ES	22.1" l x 11.8" w x 29.5" h	23.5 gal	6.6 lb	560 mm x 300 mm x 743 mm	90 L	3.0 kg	1

Dual Liner for Resin Slim Jim®

NO.	COLOR	DESCRIPTION	U.S. DIMENSIONS	U.S. CAPACITY	U.S. SHIP WT/CTN	METRIC DIMENSIONS	METRIC CAPACITY	METRIC SHIP WT/CTN	PACK
1883629		Dual Liner for Slim Jim® 90L/24G Resin FS	20.3" l x 11.8" w x 29.5" h	18.5 gal	7.8 lb	516 mm x 300 mm x 749 mm	71 L	3.5 kg	1

Damper Replacement for Resin Slim Jim®

NO.	COLOR	DESCRIPTION	U.S. DIMENSIONS	U.S. CAPACITY	U.S. SHIP WT/CTN	METRIC DIMENSIONS	METRIC CAPACITY	METRIC SHIP WT/CTN	PACK
1925497		Damper Replacement for 30L/ 8G & 50L/13G ES Resin	0.5" l x 2" w x 5.5" h		0.038 lb	13 mm x 51 mm x 140 mm		0.017 kg	1
1925498		Damper Replacement for 68L/18G & 90 L/24G ES Resin	0.5" l x 2" w x 5.5" h		0.038 lb	13 mm x 51 mm x 140 mm		0.017 kg	1
1925447		Damper Replacement for 30L/8G, 50L/13G, 68L/18G, & 90L/24G Resin FS	0.5" l x 2" w x 5.5" h		0.038 lb	13 mm x 51 mm x 140 mm		0.017 kg	1

Resin Step-On Containers

The Rubbermaid Commercial Step-On Container provides sanitary waste management.

- Slow-close, integrated lid damper keeps odors and bacteria from escaping
- Puncture-resistant, all-plastic construction
- Ideal for medical waste containment



FG614500RED

FG614600BEIG

NO.	COLOR	DESCRIPTION	U.S. DIMENSIONS	U.S. CAPACITY	U.S. SHIP WT/CTN	METRIC DIMENSIONS	METRIC CAPACITY	METRIC SHIP WT/CTN	PACK
FG614300	BEIGE	8G Resin Step-On	15.8" l x 16.3" w x 17.1" h	8 gal	6.8 lb	40.1 cm x 41.4 cm x 43.4 cm	30 L	3.1 kg	1
2089825	BLACK	8G Resin Step-On	15.8" l x 16.3" w x 17.1" h	8 gal	6.8 lb	40.1 cm x 41.4 cm x 43.4 cm	30 L	3.1 kg	1
FG614300	RED	8G Resin Step-On	15.8" l x 16.3" w x 17.1" h	8 gal	6.8 lb	40.1 cm x 41.4 cm x 43.4 cm	30 L	3.1 kg	1
FG614300	WHITE	8G Resin Step-On	15.8" l x 16.3" w x 17.1" h	8 gal	6.8 lb	40.1 cm x 41.4 cm x 43.4 cm	30 L	3.1 kg	1
FG614400	BEIGE	12G Resin Step-On	15.0" l x 16.3" x 23.6" h	12 gal	9.0 lb	38.1 cm x 41.4 cm x 59.9 cm	45 L	4.1 kg	1
2089820	BLACK	12G Resin Step-On	15.0" l x 16.3" x 23.6" h	12 gal	9.0 lb	38.1 cm x 41.4 cm x 59.9 cm	45 L	4.1 kg	1
FG614400	RED	12G Resin Step-On	15.0" l x 16.3" x 23.6" h	12 gal	9.0 lb	38.1 cm x 41.4 cm x 59.9 cm	45 L	4.1 kg	1
FG614400	WHITE	12G Resin Step-On	15.0" l x 16.3" x 23.6" h	12 gal	9.0 lb	38.1 cm x 41.4 cm x 59.9 cm	45 L	4.1 kg	1
FG614500	BEIGE	18G Resin Step-On	14.8" l x 19.8" w x 26.5" h	18 gal	12.4 lb	37.6 cm x 50.3 cm x 67.3 cm	68 L	5.6 kg	1
2089824	BLACK	18G Resin Step-On	14.8" l x 19.8" w x 26.5" h	18 gal	12.4 lb	37.6 cm x 50.3 cm x 67.3 cm	68 L	5.6 kg	1
FG614500	RED	18G Resin Step-On	14.8" l x 19.8" w x 26.5" h	18 gal	12.4 lb	37.6 cm x 50.3 cm x 67.3 cm	68 L	5.6 kg	1
FG614500	WHITE	18G Resin Step-On	14.8" l x 19.8" w x 26.5" h	18 gal	12.4 lb	37.6 cm x 50.3 cm x 67.3 cm	68 L	5.6 kg	1
FG614600	BEIGE	23G Resin Mobile Step-On	16.5" x 19.8" w x 32.6" h	23 gal	16.2 lb	41.9 cm x 50.3 cm x 82.8 cm	87 L	7.3 kg	1
2089821	BLACK	23G Resin Step-On	16.5" x 19.8" w x 32.6" h	23 gal	16.2 lb	41.9 cm x 50.3 cm x 82.8 cm	87 L	7.3 kg	1
FG614600	RED	23G Resin Mobile Step-On	16.5" x 19.8" w x 32.6" h	23 gal	16.2 lb	41.9 cm x 50.3 cm x 82.8 cm	87 L	7.3 kg	1
FG614600	WHITE	23G Resin Mobile Step-On	16.5" x 19.8" w x 32.6" h	23 gal	16.2 lb	41.9 cm x 50.3 cm x 82.8 cm	87 L	7.3 kg	1

Untouchable® Containers and Tops

Versatile and tough for indoor or outdoor applications.

Available in round, half-round, and square shapes.

- Durable and crack-resistant, even under tough indoor/outdoor conditions
 - Post-consumer recycled resin (PCR) content meets EPA guidelines
 - Use Waste Steam Label Kit Version A (1977785) to ensure waste sortation accuracy.
- See more on page 44

Untouchable® Recycling Containers

Stationary containers provide convenient central collection sites for multiple work stations or areas.

- Durable and crack-resistant, even under tough indoor/outdoor conditions
 - Post-consumer recycled resin (PCR) content meets EPA guidelines
 - Recycling options available
 - All containers come standard with the universal recycle symbol imprint
 - Use Waste Steam Label Kit Version A (1977785) to ensure waste sortation accuracy.
- See more on page 44



FG356988



ADA COMPLIANT



FG356973 / 1788374
Single-Stream



FG356973 / FG269000
Paper



FG356973 / FG269100
Bottle and Can



FG268988



Integrated pull-through hole and can liner cinch.

NO.	COLOR	DESCRIPTION	U.S. DIMENSIONS	U.S. CAPACITY	U.S. SHIP WT/CTN	METRIC DIMENSIONS	METRIC CAPACITY	METRIC SHIP WT/CTN	CAN LINERS	PACK
FG294700	GRAY	Untouchable® Round Container	15.8" dia x 18.8" h	11 gal	15.9 lb	40.0 cm dia x 47.6 cm	42.0 L	7.2 kg	5003-88 ^a	6
FG352000	GRAY, BEIG	Untouchable® Half Round Container	12" l x 21" w x 28.7" h	21 gal	29.5 lb	30.4 cm x 53.3 cm x 72.8 cm	13.4 kg	5.2 kg	5005-88 ^a	4
FG354600	GRAY	Untouchable® Round Container	15.75" dia x 30.1" h	22 gal	27.6 lb	40 cm dia x 76.5 cm	83.3 L	12.5 kg	5004-88 ^a	4
FG356988	GRAY, BEIG, BLA	Untouchable® Round Container	16.5" l x 15.5" w x 30.9" h	23 gal	21.1 lb	41.9 cm x 39.4 cm x 78.5 cm	87.1 L	9.6 kg	5004-88 ^a	4
FG395800	GRAY, BEIG	Untouchable® Square Container (liner for FG917100/FG917300/FG396500)	19.5" sq x 27.6" h	35 gal	39.4 lb	49.5 cm sq x 70.2 cm	132.5 L	17.9 kg	5008-88 ^a	4
FG395900	GRAY, BEIG	Untouchable® Square Container (liner for FG917500/FG917600)	19.5" sq x 34.3" h	50 gal	53.3 lb	49.5 cm sq x 87 cm	189.3 L	24.1 kg	5008-88 ^a	4
FG266400	GRAY, BEIG	Untouchable® Square Swing Top for FG395800, FG395900 Containers	20.13" sq x 6.3" h		22.7 lb	51.1 cm sq x 15.9 cm		10.3 kg		4
FG267200	BEIG	Untouchable® Round Swing Top for FG294700, FG354600 Containers	16.1" dia x 5.0" h		8.5 lb	40.9 cm x 12.7 cm		3.9 kg		4
FG268988	GRAY, BEIG, BLA	Untouchable® Swing Top for FG356907, FG356988 Containers	16.0" sq x 4.0" h		13.8 lb	40.6 cm sq x 10.2 cm		6.3 kg		4
FG354800*	GRAY	Untouchable® Round Funnel Top for FG294700, FG354600 Containers	16.3" dia x 4.0" h		5.5 lb	41.4 cm x 10.2 cm		2.5 kg		4
FG362000	BLA	Untouchable® Half-Round Lid, with Swing Door for FG352000 Container	21.1" sq x 9.5" h		11.4 lb	53.5 cm sq x 24.1 cm		5.1 kg		4
FG356973	BLUE	Untouchable® Square Recycling Container	16.5" l x 15.5" w x 30.9" h	23 gal	21.2 lb	41.9 cm x 39.4 cm x 78.5 cm	87.1 L	9.6 kg	5005-88 ^a	4
FG395873	BLUE	Square Recycling Container	19.5" sq x 27.6" h	35 gal	39.4 lb	49.5 cm sq x 70.2 cm	132.5 L	17.9 kg	5005-88 ^a	4
FG395973	BLUE	Square Recycling Container	19.5" sq x 34.3" h	50 gal	53.9 lb	49.5 cm sq x 87 cm	189.3 L	24.4 kg	5005-88 ^a	4
FG352073	BLUE	Half-Round Recycling Container	21.0" l x 12.0" w x 28.6" h	21 gal	28.6 lb	53.3 cm x 30.5 cm x 72.6 cm	79.5 L	13.0 kg	5005-88 ^a	4

Tops and Label Kit

NO.	COLOR	DESCRIPTION	U.S. DIMENSIONS	U.S. SHIP WT/CTN	METRIC DIMENSIONS	METRIC SHIP WT/CTN	PACK
FG279100	DBLUE	Untouchable® Bottle and Can Recycling Top for FG395873, FG395973 Containers	20.1" sq x 6.3" h	11.9 lb	51.1 cm sq x 15.9 cm	5.4 kg	4
FG279400	DBLUE	Untouchable® Paper Recycling Top for FG395873, FG395973 Containers	20.1" sq x 6.3" h	14.5 lb	51.1 cm sq x 15.9 cm	6.6 kg	4
1788374	BLUE	Untouchable® Single-Stream Recycling Top for FG356988 Container	16.0" sq x 3.2" h	4.7 lb	40.6 cm sq x 8.1 cm	2.1 kg	4
1788375	GREEN	Untouchable® Single-Stream Recycling Top for FG356988 Container	16.0" sq x 3.2" h	4.7 lb	40.6 cm sq x 8.1 cm	2.1 kg	4
FG269000	BLUE	Untouchable® Paper Recycling Top for FG356988 Container	16.0" sq x 3.2" h	4.4 lb	40.6 cm sq x 8.1 cm	2.0 kg	4
FG269100	BLUE	Untouchable® Bottle and Can Recycling Top for FG356988 Container	16.0" sq x 3.2" h	4.4 lb	40.6 cm sq x 8.1 cm	2.0 kg	4



Deskside Waste and Recycling Baskets and Tops

Space-efficient, economical, and an easy and effective way to recycle.

- All-plastic construction won't chip, rust, or dent. Rolled rims add strength, and are easy to clean
- Fits under standard-height desk even when swing top is fully extended
- Recycling options available
- Use Waste Stream Label Kit Version A (1977785) to ensure waste sortation accuracy. See more on page 44.



Rolled rim adds strength to the already durable Rubbermaid design.

Innovative rim tabs prevent jamming when nested.



Rubbermaid's reliable, puncture-resistant, all-plastic construction means they won't rust or chip and will stand up to years of use.

Rounded corners and smooth contours make for easy cleaning and emptying.

FG295600

FG295673 with
FG295073 Side Bin

Side bins create a compact deskside recycling center.

- Add side bins to turn a regular wastebasket into a convenient recycling station
- Customize with different colors for all your recycling sortation needs
- Designed to fit under any standard desk or counter while handling all the waste in a day's work

Deskside Wastebaskets

NO.	COLOR	DESCRIPTION	U.S. DIMENSIONS	U.S. CAPACITY	U.S. SHIP WT/CTN	METRIC DIMENSIONS	METRIC CAPACITY	METRIC SHIP WT/CTN	CAN LINERS	PACK
FG295500	GRAY, BEIG, BLA	Wastebasket, Small	11.4" l x 8.3" w x 12.13" h	13% qt	14.3 lb	28.9 cm x 21 cm x 30.8 cm	12.9 L	6.5 kg	5002-88	12
2044159	WHITE	Wastebasket, Small	11.4" l x 8.3" w x 12.13" h	13% qt	14.3 lb	28.9 cm x 21 cm x 30.8 cm	12.9 L	6.5 kg	5002-88	12
FG295600	GRAY, BEIG, BLA	Wastebasket, Medium	14.4" l x 10.3" w x 15.0" h	28% qt	20.7 lb	36.5 cm x 26 cm x 38.1 cm	26.6 L	9.4 kg	5002-88	12
2044160	WHITE	Wastebasket, Medium	14.4" l x 10.3" w x 15.0" h	28% qt	20.7 lb	36.5 cm x 26 cm x 38.1 cm	26.6 L	9.4 kg	5002-88	12
2031824	BLUE	Wastebasket, Medium	14.4" l x 10.3" w x 15.0" h	28% qt	20.7 lb	36.5 cm x 26 cm x 38.1 cm	26.6 L	9.4 kg	5002-88	12
2031812	GREEN	Wastebasket, Medium	14.4" l x 10.3" w x 15.0" h	28% qt	20.7 lb	36.5 cm x 26 cm x 38.1 cm	26.6 L	9.4 kg	5002-88	12
FG295700	GRAY, BEIG, BLA	Wastebasket, Large	11.3" l x 15.3" w x 20" h	41% qt	27.3 lb	27.9 cm x 39.4 cm x 52.7 cm	12.4 kg	12.4 kg	5003-88	12

Deskside Recycling Containers

NO.	COLOR	DESCRIPTION	U.S. DIMENSIONS	U.S. CAPACITY	U.S. SHIP WT/CTN	METRIC DIMENSIONS	METRIC CAPACITY	METRIC SHIP WT/CTN	CAN LINERS	PACK
FG295073	BLUE, GRAY, BLA	Side Bin Recycling Center	10.6" l x 7.3" w x 11.7" h	4% qt	9.0 lb	26.9 cm x 18.5 cm x 29.7 cm	4.50 L	4.1 kg		12
FG295573	BLUE	Deskside Recycling Container, Small with Universal Recycle Symbol	11.4" l x 8.3" w x 12.1" h	13% qt	14.3 lb	29.0 cm x 21.0 cm x 30.8 cm	12.9 L	6.5 kg	5002-88	12
FG295606	GRN	Deskside Recycling Container, Medium with Universal Recycle Symbol	14.5" l x 10.5" w x 15.0" h	28% qt	21.7 lb	36.8 cm x 26.7 cm x 38.1 cm	26.6 L	9.8 kg	5002-88	12
FG295673	BLUE	Deskside Recycling Container, Medium with Universal Recycle Symbol	14.5" l x 10.5" w x 15.0" h	28% qt	21.7 lb	36.8 cm x 26.7 cm x 38.1 cm	26.6 L	9.8 kg	5002-88	12
FG295773	BLUE	Deskside Recycling Container, Large with Universal Recycle Symbol	15.3" l x 11.3" w x 20.0" h	41% qt	28.3 lb	38.7 cm x 28.6 cm x 50.8 cm	39 L	12.8 kg	5003-88	12

Untouchable® Wastebasket Tops and Combos

NO.	COLOR	DESCRIPTION	U.S. DIMENSIONS	U.S. CAPACITY	U.S. SHIP WT/CTN	METRIC DIMENSIONS	METRIC CAPACITY	METRIC SHIP WT/CTN	CAN LINERS	PACK
FG306600	BLA, BEIG	Untouchable® Swing Top for FG295600 Container	15.0" l x 10.9" w x 6.0" h		6.6 lb	38.1 cm x 27.6 cm x 15.2 cm		2.9 kg		6
1779742	GRAY	Untouchable® Swing Top for FG295600 Container	15.0" l x 10.9" w x 6.0" h		6.6 lb	38.1 cm x 27.6 cm x 15.2 cm		2.9 kg		6
FG306700	BLA	Untouchable® Swing Top for FG295700 Container	16.0" l x 11.6" w x 7.9" h		8.5 lb	40.6 cm x 29.5 cm x 20.0 cm		3.9 kg		6
1829407	BLUE	Untouchable® Swing Top for FG295700 Container	16.0" l x 11.6" w x 7.9" h		8.5 lb	40.6 cm x 29.5 cm x 20.0 cm		3.9 kg		6
1829409	GRAY	Untouchable® Swing Top for FG295700 Container	16.0" l x 11.6" w x 7.9" h		8.5 lb	40.6 cm x 29.5 cm x 20.0 cm		3.9 kg		6

^ Not for sale in California.

Hide-A-Bag

Award-winning design conceals can liner for a neat appearance.

- Fire-safe steel construction
- Noncorrosive vinyl base ring protects floors



NO.	COLOR	DESCRIPTION	CAPACITY (GAL)	CAPACITY (LITERS)	U.S. DIMENSIONS	U.S. SHIP WT/CTN	METRIC DIMENSIONS	METRIC SHIP WT/CTN	CARTON QUANTITY
Ⓢ FGWHB14	SS	Hide-a-Bag Open-Top Wastebasket, Stainless	3.5	13.2	9.5" dia x 12.5" h	7.0 lb	24.1 cm dia x 31.8 cm	3.2 kg	
Ⓢ FGWHB14E	BK	Hide-a-Bag Open-Top Wastebasket, Black	3.5	13.2	9.5" dia x 12.5" h	8.0 lb	24.1 cm dia x 31.8 cm	3.6 kg	

Black (BK), Stainless Steel (SS)

Concept Collection™

Designer solutions for desk-side disposal.

- "No snag" curled rim protects clothing
- Baked-on epoxy finish
- Solid steel base
- Vinyl base ring protects floors



FGWB29RSS



FGWMB30RBK



FGWMB20BK

NO.	COLOR	DESCRIPTION	CAPACITY (GAL)	CAPACITY (LITERS)	U.S. DIMENSIONS	U.S. SHIP WT/CTN	METRIC DIMENSIONS	METRIC SHIP WT/CTN	CARTON QUANTITY
FGWB29R	SS	Concept Collection™ Open-Top Wastebasket	7.25	27.4	24.0" l x 15.5" w x 11.0" h	14.6 lb	60.9 cm x 39.3 cm x 27.9 cm	6.6 kg	3
FGWMB20	BK, SLV	Concept Collection™ Open-Top Wastebasket	5	18.9	11.5" dia x 14" h	10.2 lb	29.2 cm dia x 35.6 cm	4.6 kg	6
FGWMB30R	BK	Concept Collection™ Open-Top Wastebasket	7.5	28.4	16.0" l x 8.5" w x 14.0" h	7.0 lb	40.6 cm x 21.6 cm x 35.6 cm	3.2 kg	3

Black (BK), Stainless Steel (SS)

Profile Containers

Attractive design suits many decors.

- Wall mounting keeps the container out of pedestrian traffic and allows for floor cleaning
- Spring-loaded swing door helps control odor and hides trash from public view
- Comes with complete hardware and instructions for wall mounting
- Factory Mutual (FM) approved for fire safety when wall mounted; ideal for hallways and other uncontrolled public areas
- Slim design limits intrusion into corridors, washrooms, kitchens, and other limited space areas



ADA COMPLIANT



FG782200



FG782200

NO.	COLOR	DESCRIPTION	U.S. DIMENSIONS	U.S. CAPACITY	U.S. SHIP WT/CTN	METRIC DIMENSIONS	METRIC CAPACITY	METRIC SHIP WT/CTN	CAN LINERS	PACK
FG782200	BRN, BEIG	Slim Jim® Wall-Mounted Container	19.5" l x 11.9" w x 32.6" h	15 gal	11.6 lb	49.5 cm x 30.2 cm x 82.9 cm	56.8 L	5.3 kg	5005-88*	1

*Not for sale in California.

Fire-Resistant Wastebaskets

Great for use in areas requiring increased levels of fire protection, such as hospitals, schools, and hotels.

- UL® Classification ensures fire safety
- Textured finish for enhanced aesthetics



CSFM

FG254400



FG254100

FG254300

FG254000

NO.	COLOR	DESCRIPTION	U.S. DIMENSIONS	U.S. CAPACITY	U.S. SHIP WT/CTN	METRIC DIMENSIONS	METRIC CAPACITY	METRIC SHIP WT/CTN	CAN LINERS	PACK
FG254000	BEIG	Fire-Resistant Wastebasket	8.9" l x 6.4" w x 10.3" h	7 qt	10.2 lb	22.6 cm x 16.2 cm x 26.2 cm	6.6 L	4.6 kg		6
FG254100	GRAY, BLA, BEIG	Fire-Resistant Wastebasket	11.1" l x 8.3" w x 12.3" h	14 qt	19.6 lb	28.3 cm x 21 cm x 31.1 cm	13.2 L	8.9 kg		6
FG254300	GRAY, BLA, BEIG	Fire-Resistant Wastebasket	14.5" l x 10.5" w x 15.3" h	28 qt	30.4 lb	36.8 cm x 26.7 cm x 38.9 cm	26.5 L	13.8 kg		6
FG254400	BEIG	Fire-Resistant Wastebasket	15.0" l x 11.3" w x 20.0" h	40 qt	29.6 lb	38.1 cm x 28.6 cm x 50.8 cm	37.9 L	13.4 kg		4

For Other Fire-Rated Containers See:



Profile Wall-Mounted



Step-On Containers



Steel Containers



Plaza® Containers



Ranger® Containers



Smoking Management Containers

When ordering products with **BOLD** color codes, please specify color code after the product number. Refer to the Standard Color Guide at the back of the catalog.

Recycling Boxes

The Rubbermaid Commercial Recycling Bin is made of post-consumer recycled resin for commercial recycling use.

- Built-in handles for easier lifting and carrying
- Designed to stack or nest for increased productivity
- Commercial-grade construction to withstand years of indoor and outdoor use



FG571873BLUE



FG571873GRN

NO.	COLOR	DESCRIPTION	U.S. DIMENSIONS	U.S. CAPACITY	U.S. SHIP WT/CTN	METRIC DIMENSIONS	METRIC CAPACITY	METRIC SHIP WT/CTN	CAN LINERS	PACK
FG571473	BLUE, GRN	14-Gallon Recycling Box	20.75" l x 16" w x 14.75" h	14 gal	25.23 lb	52.7 cm x 40.6 cm x 37.5 cm	53 L	11.4 kg		6
FG571873	BLUE, GRN	18-Gallon Recycling Box	25.75" l x 16.5" w x 26.5" h	18 gal	30.36 lb	65.4 cm x 41.9 cm x 67.3 cm	68.1 L	13.8 kg		6

Glutton® Recycling Stations

High-capacity, all-in-one centralized solutions for efficient waste sortation.

- 2-stream and 4-stream options are available



Two-Stream Glutton® Recycling Station
1792340



Four-Stream Glutton® Recycling Station
1792372

Flexible Labeling

Includes separate color-coded symbol and word labels for customizing the Recycling Station based on facility needs.

Multiple Stream Sortation

Use any combination of the restrictive-opening tops to sort up to four separate waste streams. Tops snap securely into lid.

High-Capacity Collection

Improves productivity by reducing the frequency of trips to empty the filled containers. Holds up to 92 gallons of waste.



Permanent Hot-Stamped Logo

Durable Construction
Features traditional Rubbermaid Commercial Products' strength and durability in easy-to-clean, impact-resistant post-consumer plastic.

NO.	COLOR	DESCRIPTION	U.S. DIMENSIONS	U.S. CAPACITY	U.S. SHIP WT/CTN	METRIC DIMENSIONS	METRIC CAPACITY	METRIC SHIP WT/CTN	PACK
1792339	BLUE	Two-Stream Glutton® Recycling Station	26.8" l x 23.6" w x 35.5" h	46 gal	41 lb	68.1 cm x 59.9 cm x 90.2 cm	174.1 L	18.6 kg	1
1792340	GREEN	Two-Stream Glutton® Recycling Station	26.8" l x 23.6" w x 35.5" h	46 gal	41 lb	68.1 cm x 59.9 cm x 90.2 cm	174.1 L	18.6 kg	1
1792371	BEIGE	Two-Stream Glutton® Recycling Station	26.8" l x 23.6" w x 35.5" h	46 gal	41 lb	68.1 cm x 59.9 cm x 90.2 cm	174.1 L	18.6 kg	1
FG256L00	DBLUE	Glutton® Bottle and Can Recycling Top for FG256B73 Container	26.63" l x 23.0" w x 13.0" h	N/A	14.2 lb	67.6 cm x 58.4 cm x 33 cm	N/A	7.5 kg	1
FG256B73	BLUE	Glutton® Recycling Container	25.5" l x 22.8" w x 31.1" h	56 gal	66.5 lb	64.8 cm x 57.8 cm x 79.1 cm	212 L	30.2 kg	4
1792372	BLUE	Four-Stream Glutton® Recycling Station	53.0" l x 24.0" w x 35.5" h	92 gal	67.3 lb	134.6 cm x 61 cm x 90.2 cm	348.3 L	30.5 kg	1
1792373	GREEN	Four-Stream Glutton® Recycling Station	53.0" l x 24.0" w x 35.5" h	92 gal	67.3 lb	134.6 cm x 61 cm x 90.2 cm	348.3 L	30.5 kg	1
1792374	BEIGE	Four-Stream Glutton® Recycling Station	53.0" l x 24.0" w x 35.5" h	92 gal	67.3 lb	134.6 cm x 61 cm x 90.2 cm	348.3 L	30.5 kg	1
1792975		Waste Stream Label Kit	8.2" w x 6.8" h	N/A	1.8 lb	20.8 cm x 17.2 cm	N/A	0.8 kg	8



Steel Wastebasket Open Tops

Fire-safe, puncture-resistant steel wastebaskets

- UL® Classification ensures fire safety; the raised bottom prevents heat transfer in case of fire



Steel Wastebasket Dome Tops

Fire-safe, puncture-resistant steel wastebaskets

- UL® Classification ensures fire safety; the raised bottom prevents heat transfer in case of fire



FGBBT1529GR
(Dome Top)



FGWB2029GR



FGWB96RBK



FGWB26BK

Steel Wastebasket Open Tops

NO.	COLOR	DESCRIPTION	U.S. DIMENSIONS	U.S. CAPACITY	U.S. SHIP WT/CTN	METRIC DIMENSIONS	METRIC CAPACITY	METRIC SHIP WT/CTN	CAN LINERS	PACK
FGWB26 [†]	AL, BK, GR	Steel Wastebasket Open Top	13.5" dia x 14.5" h	26 qt	31.6 lb	34.3 cm dia x 36.8 cm	98.4 L	14.3 kg		6
FGWB30R [*]	AL, GR	Steel Wastebasket Open Top	17.0" w x 15.0" h	30 qt	17.0 lb	43.2 cm x 38.1 cm	113.6 L	7.7 kg		3
FGWB2029 ^{**}	GR	Steel Wastebasket Open Top	16.0" dia x 29.0" h	80 qt	28.0 lb	40.6 cm dia x 73.7 cm	302.8 L	12.7 kg		3
FGWB96R	AL, BK	Steel Wastebasket Open Top	21.0" w x 30.0" h	96 qt	37.0 lb	53.3 cm x 76.2 cm	363.4 L	16.8 kg		3

Almond (AL), Black (BK), Gray (GR) †UL-Classified ‡FM-approved *UL-Listed when used with FGBBT1529

Steel Wastebasket Dome Top

NO.	COLOR	DESCRIPTION	U.S. DIMENSIONS	U.S. CAPACITY	U.S. SHIP WT/CTN	METRIC DIMENSIONS	METRIC CAPACITY	METRIC SHIP WT/CTN	CAN LINERS	PACK
FGBBT1529 [*]	BK, GR	Steel Wastebasket Dome Top for FGWB2029	16.2" dia x 9.4" h	N/A	6.0 lb	41.3 cm x 23.8 cm	N/A	2.7 kg		1

Black (BK), Gray (GR) †UL-Listed *FM-approved

Can Liners

High-quality can liners for a variety of applications.

- Strong "star seal" bottom eliminates gaps along the seal where leaks can occur
- Easily conforms to the shape of the container
- Distributes refuse weight evenly inside the liner

High-Density Coreless Roll

Great for paper and nonsharp objects under moderate transport conditions.

- Excellent resistance to puncture and light resistance to tearing
- Greater load capacity than linear low-density can liners
- Continuous coreless roll makes dispensing easy and reduces theft

Linear Low-Density

Recommended for sharper objects under tougher transport conditions.

- Excellent resistance to puncture and tearing
- Good load capacity
- Topside dual-dispensing carton allows for top or side dispensing



Star Seal Bottom
Strong star seal bottom is designed without gussets, where leaks are prone to occur.



Buy the right-sized can liner for your Rubbermaid Commercial Products containers!

APPLICATIONS

HIGH-DENSITY	LINEAR LOW-DENSITY
Restaurants	Janitorial
Office paper	Housekeeping
Construction	Everyday use
Parks/stadiums	Schools

High-Density Coreless Roll Can Liners

NO.	COLOR	DESCRIPTION	U.S. DIMENSIONS	U.S. SIZE	U.S. CAPACITY	U.S. SHIP WT/CTN	METRIC DIMENSIONS	METRIC SIZE	METRIC CAPACITY	METRIC SHIP WT/CTN	U.S./METRIC GAUGE	PACK
FG507900	CLR	High-Density Coreless Roll Can Liners	49.0" l x 43.0" w	86" cir	45–56 gal	18.6 lb	124.5 cm x 109.2 cm	218.4 cm	170–211 L	8.4 kg	.63 mil/16 µm	1/200 pcs

Materials comply with USDA and FDA regulations for food contact.

Linear Low-Density Can Liners

NO.	COLOR	FITS (ALL PRODUCT NUMBERS BEGIN WITH "FG")	U.S. DIMENSIONS	U.S. SIZE	U.S. CAPACITY	U.S. SHIP WT/CTN	METRIC DIMENSIONS	METRIC SIZE	METRIC CAPACITY	METRIC SHIP WT/CTN	U.S./METRIC GAUGE	PACK
FG500288 ^a	CLR	295200, 295500, 295600, 614200	24.0" l x 21.5" w	43" cir	6 gal	29.6 lb	61.0 cm x 54.6 cm	109.2 cm	22.7 L	13.4 kg	0.8 mil/20 µm	1/1000 pcs
FG500388 ^a	CLR	261000, 294700, 295700, 307120	30.0" l x 23.75" w	47½" cir	11 gal	20.3 lb	76.2 cm x 60.3 cm	120.6 cm	41.6 L	9.2 kg	0.8 mil/20 µm	1/500 pcs
FG500488 ^a	GRAY	354600, 816088, 818488, 818588, 614300, 614400, 617700	38.8" l x 24.5" w	49" cir	22 gal	20.2 lb	98.4 cm x 62.2 cm	124.4 cm	83.3 L	9.2 kg	1.0 mil/25 µm	1/300 pcs
FG500588 ^a	GRAY	352000, 356800, 356900, 782200, 782300, 817088, 818088, 818288, 818588	39.0" l x 27.5" w	55" cir	23 gal	22.7 lb	99.1 cm x 69.9 cm	139.7 cm	87.1 L	10.3 kg	1.0 mil/25 µm	1/300 pcs
FG500688 ^a	GRAY	262000, 614687	34.0" l x 30.0" w	60" cir	20 gal	26.3 lb	86.4 cm x 76.2 cm	152.4 cm	75.7 L	11.9 kg	1.2 mil/30 µm	1/300 pcs
FG500788 ^a	GRAY	263200, 263400, 263246, 263256	39.0" l x 34.0" w	68" cir	32 gal	33.7 lb	99.1 cm x 86.4 cm	172.7 cm	121.1 L	15.3 kg	1.2 mil/30 µm	1/300 pcs
FG500888 ^a	CLR	264100, 264300, 395800, 395900, 905800, 9P9000, 264346, 264356, 9P9100, 965100, 965200	44.0" l x 37.0" w	74" cir	44–50 gal	27.3 lb	111.8 cm x 94 cm	187.9 cm	166.5–189.2 L	12.4 kg	1.2 mil/30 µm	1/200 pcs
FG500988 ^a	GRAY	354000, 354100, 396600, 396700, 614500, 614600, 818288, 355400, 354220	40.0" l x 29.3" w	58½" cir	20–32 gal	29.9 lb	101.6 cm x 74.3 cm	148.5 cm	75.7–121.1 L	13.6 kg	1.2 mil/30 µm	1/300 pcs
FG501088 ^a	GRAY	50-Gal (208.2-L) Drum	60.0" l x 36.0" w	72" cir	55 gal	18.4 lb	152.4 cm x 91.4 cm	182.8 cm	208.2 L	8.3 kg	1.2 mil/30 µm	1/100 pcs
FG501188 ^a	GRAY	265500	48.0" l x 39.5" w	79" cir	55 gal	27.0 lb	121.9 cm x 100.3 cm	200.6 cm	208.2 L	12.2 kg	2.0 mil/50 µm	1/100 pcs
FG501388 ^a	GRAY, CLR	256800, 256806, 9W2700, 9W2706	47.0" l x 43.0" w	86" cir	56 gal	28.7 lb	119.4 cm x 109.2 cm	218.4 cm	212 L	13 kg	2.0 mil/50 µm	1/100 pcs
FG501688 ^a	GRAY	351700, 352600, 396300, 396400, 396500, 396800, 396900, 397000, 397100, 397200, 397500, 843000, 917100, 917200, 917300	42.5" l x 39.0" w	78" cir	45 gal	28.3 lb	108 cm x 99.1 cm	198.1 cm	170.3 L	12.8 kg	1.2 mil/30 µm	1/200 pcs
FG502888 ^a	GRAY	50-Gallon (189.3-L) Container 9W2700, 9W2706	47.0" l x 45.0" w	90" cir	50 gal	30.0 lb	119.4 cm x 114.3 cm	228.6 cm	189.3 L	13.6 kg	2.0 mil/50 µm	1/100 pcs

^aNot for sale in California.



Utility Refuse Waste Stream Label Kits*

The Waste Stream Label Kits contain ten intuitive waste stream decals, ensuring waste sortation accuracy.

Version A (1977785) Fits 20 Gal BRUTE® Containers, 23 and 35 Gal Untouchable Containers, and Medium and Large Wastebaskets

Version C (1977787) Fits 32 and 44 Gal BRUTE® Containers.

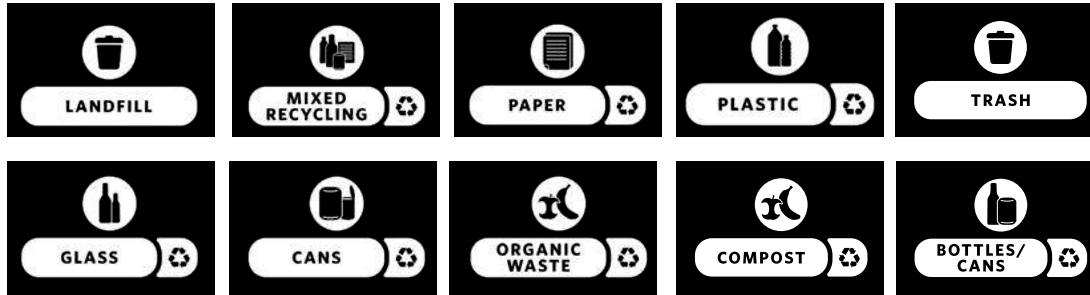

Version D (1977788) fits 50 Gal BRUTE® Rollout Containers and 1/2- and 1-Cubic-Yard Tilt Trucks

Version F (2018391) fits 16- and 23- Gal Slim Jim® Containers

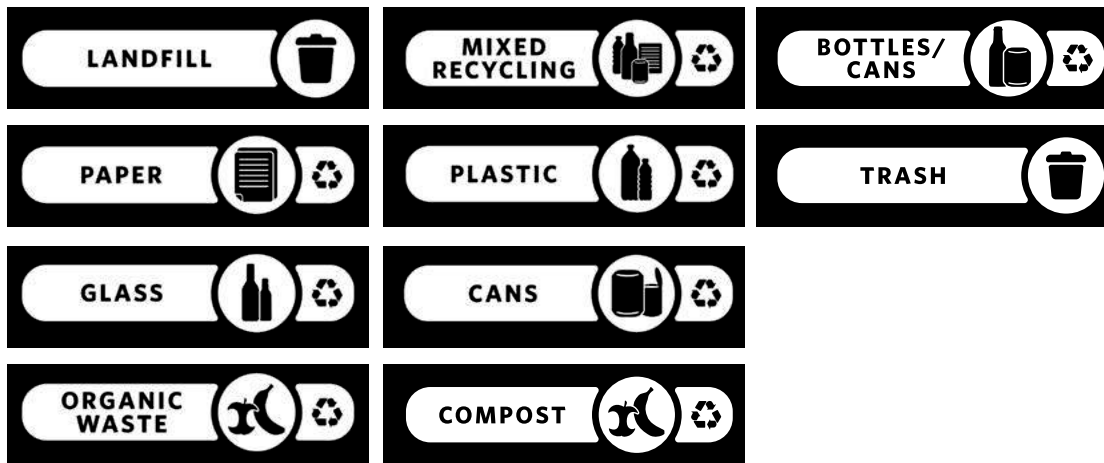

VERSION E (1977789) fits 16- and 23-Gal Slim Jim® Containers

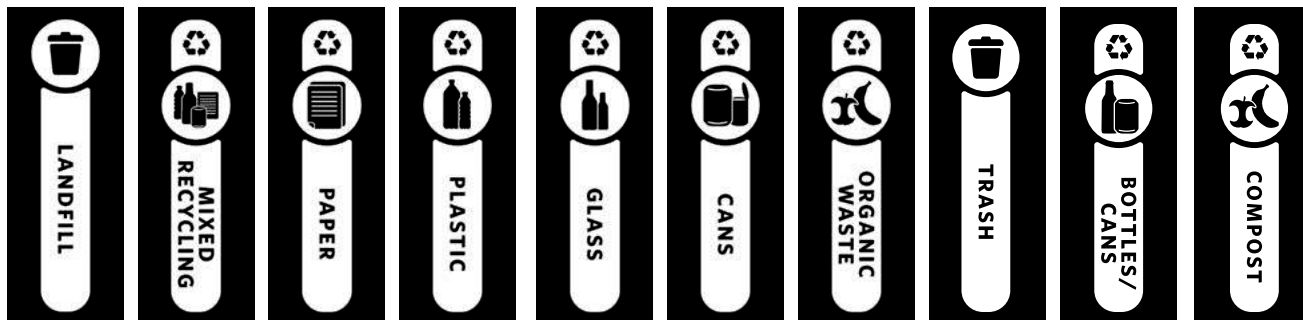

*Sized to fit correct container.

UTILITY REFUSE AND RECYCLING

DECORATIVE REFUSE

CLEANING

MATERIAL HANDLING

WASHROOM

FOODSERVICE

ACCESSORIES & INDEX

UTILITY REFUSE WASTE STREAM LABEL KITS

NO.	DESCRIPTION	U.S. DIMENSIONS	PACK
1977785	Waste Stream Label Kit Version A fits 20-Gallon BRUTE® Containers, 23- and 35-Gallon Untouchable® Containers, and Medium and Large Wastebaskets	7.8" w x 4.6" h	1
1977787	Waste Stream Label Kit Version C fits 32- and 44-Gallon BRUTE® Containers	9.5" w x 5.7" h	1
1977788	Waste Stream Label Kit Version D fits 50-Gallon BRUTE® Rollout Containers and ½- and 1-Cubic-Yard Tilt Trucks	10.3" w x 2.6" h	1
1977789	Waste Stream Label Kit Version E fits 16- and 23-Gallon Slim Jim® Containers (Vertical orientation)	2.6" w x 10.3" h	1
2018391	Waste Stream Label Kit Version F fits 16- and 23-Gallon Slim Jim® Containers (Horizontal orientation)	7.5" w x 1.93" h	1

* Labels have clear substrate to allow color of container to show through.



1956185, 1955959, 1956191



DECORATIVE REFUSE



FGR1536EOTPLBK



1961621, 1961629

DECORATIVE REFUSE

INDOOR/OUTDOOR CONTAINERS

Configure™	48
Classics.....	50

INDOOR CONTAINERS

Silhouettes.....	51
Defenders®	52
Round Tops.....	53
Crowne.....	53
Half Rounds.....	54
Metallic Series	54
Atrium®	55
Slim Jim® Step-On Containers.....	55
Metal Waste Stream Labls	56
Eclipse	57
Marshal® Classic.....	57

OUTDOOR CONTAINERS

Aspen.....	58
Dimension	58
Americana Series™	59
Atrium® Classic.....	59
Landmark Series®.....	60
Ranger®	62
Plaza®	63
Street Baskets.....	64
Steel Drum Tops	64
Glutton®	64

SMOKING MANAGEMENT

Smokers' Station® Wall Mount	65
Classic Smoking Urns and Accessories	65
Ash/Trash Containers	66
GroundsKeeper® Receptacles	66
Infinity™ Smoking Management Solutions	67
Metropolitan Smokers' Station	68
Smokers' Pole	69
Aladdin Smokers' Station®	69
Waste Container Accessories	70

Configure™

Configure™ decorative refuse containers have a modern appearance that will fit seamlessly into any commercial environment. Mix and match waste stream labels, capacities, and signage to meet facility-specific waste and recycling needs.

- Magnetic connection keeps the containers arranged in the order that best fits the space – in a row or an island
- Easy-access front door and handle allow for ergonomic emptying of waste
- Internal door hinge prevents unsightly wall damage and helps maintain a neat, clean appearance in commercial spaces



ADA COMPLIANT



EASY ACCESS FRONT DOOR

INTERGRATED LINER CINCHES

INTEGRATED LINER HANDLES



1961626

LINERS WITH
VENTING CHANNELS

SKU #	DESCRIPTION	FRONT COLOR	SIDE/BACK COLOR	LID STYLE	GALLONS	LENGTH	WIDTH	HEIGHT
1961614	15G with Landfill Label	Grey Stenni Gloss	Textured Black	Open Top	15	14.41	18.50	37.97
1961615	15G with Mixed Label	Grey Stenni Gloss	Textured Black	Open Top	15	14.41	18.50	37.97
1961616	15G with Paper Label	Grey Stenni Gloss	Textured Black	Open Top	15	14.41	18.50	37.97
1961617	15G with Plastic Label	Grey Stenni Gloss	Textured Black	Open Top	15	14.41	18.50	37.97
1961618	15G with Glass Label	Grey Stenni Gloss	Textured Black	Open Top	15	14.41	18.50	37.97
1961619	15G with Cans Label	Grey Stenni Gloss	Textured Black	Open Top	15	14.41	18.50	37.97
1961620	15G with Organic Label	Grey Stenni Gloss	Textured Black	Open Top	15	14.41	18.50	37.97
1961621	23G with Landfill Label	Grey Stenni Gloss	Textured Black	Open Top	23	19.21	18.50	37.97
1961622	23G with Mixed Label	Grey Stenni Gloss	Textured Black	Open Top	23	19.21	18.50	37.97
1961623	23G with Paper Label	Grey Stenni Gloss	Textured Black	Open Top	23	19.21	18.50	37.97
1961624	23G with Plastic Label	Grey Stenni Gloss	Textured Black	Open Top	23	19.21	18.50	37.97
1961625	23G with Glass Label	Grey Stenni Gloss	Textured Black	Open Top	23	19.21	18.50	37.97
1961626	23G with Cans Label	Grey Stenni Gloss	Textured Black	Open Top	23	19.21	18.50	37.97
1961627	23G with Organic Label	Grey Stenni Gloss	Textured Black	Open Top	23	19.21	18.50	37.97
1961628	33G with Landfill Label	Grey Stenni Gloss	Textured Black	Open Top	33	24.02	18.50	37.97
1961629	33G with Mixed Label	Grey Stenni Gloss	Textured Black	Open Top	33	24.02	18.50	37.97
1961630	33G with Paper Label	Grey Stenni Gloss	Textured Black	Open Top	33	24.02	18.50	37.97
1961641	33G with Plastic Label	Grey Stenni Gloss	Textured Black	Open Top	33	24.02	18.50	37.97
1961642	33G with Glass Label	Grey Stenni Gloss	Textured Black	Open Top	33	24.02	18.50	37.97
1961505	33G with Cans Label	Grey Stenni Gloss	Textured Black	Open Top	33	24.02	18.50	37.97
1961506	33G with Organic Label	Grey Stenni Gloss	Textured Black	Open Top	33	24.02	18.50	37.97
1961507	45G with Landfill Label	Grey Stenni Gloss	Textured Black	Open Top	45	28.82	18.50	37.97
1961508	45G with Mixed Label	Grey Stenni Gloss	Textured Black	Open Top	45	28.82	18.50	37.97
1961509	45G with Paper Label	Grey Stenni Gloss	Textured Black	Open Top	45	28.82	18.50	37.97
1961510	45G with Plastic Label	Grey Stenni Gloss	Textured Black	Open Top	45	28.82	18.50	37.97
1961681	45G with Glass Label	Grey Stenni Gloss	Textured Black	Open Top	45	28.82	18.50	37.97
1961682	45G with Cans Label	Grey Stenni Gloss	Textured Black	Open Top	45	28.82	18.50	37.97
1961683	45G with Organic Label	Grey Stenni Gloss	Textured Black	Open Top	45	28.82	18.50	37.97

Additional Signage

SKU #	DESCRIPTION	FRONT COLOR	COMPATIBLE WITH THE FOLLOWING CONFIGURE CONTAINERS	LENGTH	WIDTH	HEIGHT
1961589	15G with Paper Label	Blue	15	13.95	1.75	8.49
1961584	15G with Plastic Label	Red	15	13.95	1.75	8.49
1961576	15G with Glass Label	Orange	15	13.95	1.75	8.49
1961596	15G with Cans Label	Yellow	15	13.95	1.75	8.49
1961580	15G with Organic Waste Label	Green	15	13.95	1.75	8.49
1961572	15G with Landfill Label	Black	15	13.95	1.75	8.49
1961588	15G with Mixed Recycling Label	Blue	15	13.95	1.75	8.49
1961573	23G with Landfill Label	Black	23	18.75	1.75	8.49
1961590	23G with Mixed Recycling Label	Blue	23	18.75	1.75	8.49
1961591	23G with Paper Label	Blue	23	18.75	1.75	8.49
1961585	23G with Plastic Label	Red	23	18.75	1.75	8.49
1961577	23G with Glass Label	Orange	23	18.75	1.75	8.49
1961597	23G with Cans Label	Yellow	23	18.75	1.75	8.49
1961581	23G with Organic Waste Label	Green	23	18.75	1.75	8.49
1961574	33G with Landfill Label	Black	33	23.55	1.75	8.49
1961592	33G with Mixed Recycling Label	Blue	33	23.55	1.75	8.49
1961593	33G with Paper Label	Blue	33	23.55	1.75	8.49
1961586	33G with Plastic Label	Red	33	23.55	1.75	8.49
1961578	33G with Glass Label	Orange	33	23.55	1.75	8.49
1961598	33G with Cans Label	Yellow	33	23.55	1.75	8.49
1961582	33G with Organic Waste Label	Green	33	23.55	1.75	8.49
1961575	45G with Landfill Label	Black	45	28.36	1.75	8.49
1961594	45G with Mixed Recycling Label	Blue	45	28.36	1.75	8.49
1961595	45G with Paper Label	Blue	45	28.36	1.75	8.49
1961587	45G with Plastic Label	Red	45	28.36	1.75	8.49
1961579	45G with Glass Label	Orange	45	28.36	1.75	8.49
1961599	45G with Cans Label	Yellow	45	28.36	1.75	8.49
1961583	45G with Organic Waste Label	Green	45	28.36	1.75	8.49



1961572/1961614, 1961588/1961616, 1961596/1961619, 1961580/1961620

Classics

The heavy-duty Classics decorative refuse container has a perforated steel design for a clean and modern appearance. This container is a smart choice for high-traffic areas and can be used both outdoors and indoors.

- Retainer bands discreetly hold liner bags in place and out of sight
- Lid is fastened to receptacle with a cable, making it easier to collect waste
- Heavy-Gauge Steel for lasting durability in high-traffic areas
- Includes rigid plastic liner



ADA COMPLIANT



FGS3SSTSSPL

SKU #	DESCRIPTION	COLOR	GALLONS	LENGTH	WIDTH	HEIGHT
FGS3ETBKPL	Open Top 94L/25G	Textured Black	25	18.00	18.00	36.00
FGS3ETHBZPL	Open Top 94L/25G	Textured Bronze	25	18.00	18.00	36.00
FGS3ETSMPLBK	Open Top 94L/25G	Stardust Silver Metallic	25	18.00	18.00	36.00
FGS3SSTSSPL	Open Top 94L/25G	Stainless Steel	25	18.00	18.00 <td 36.00	
FGS55ETBKPL	Open Top 193L/51G	Textured Black	51	24.00	24.00	36.00
FGS55ETSMPLBK	Open Top 193L/51G	Stardust Silver Metallic	51	24.00	24.00	36.00
FGS55SSTSSPL	Open Top 193L/51G	Stainless Steel	51	24.00	24.00	36.00



FGS55SSTSSPL

Silhouettes

The sleek Silhouettes decorative refuse container has a contemporary graphic pattern designed to seamlessly and beautifully blend with indoor modern environments.

- Lid is fastened to receptacle for easy waste removal
- Optional waste stream decals and lid shape openings available for easier recycling compliance
- Leg levelers provide stability on uneven surfaces
- Includes rigid plastic liner



ADA COMPLIANT

DISCREET LABELS:



*Additional Waste Stream Labels on page 56



Large Rectangle
FGSR18SSPL



Square Open Top
FGSC18EPLTBK

SKU #	DESCRIPTION	COLOR	GALLONS	LENGTH	WIDTH	HEIGHT
FGSR14EPLSM	Small Rectangle 49L/13G	Stardust Silver Metallic	13	19.49	9.76	30.35
FGSR14SSPL	Small Rectangle 49L/13G	Stainless Steel	13	19.49	9.76	30.35
FGSC14EPLSM	Square Open Top 60L/16G	Stardust Silver Metallic	16	14.76	14.76	30.35
FGSC14SSPL	Square Open Top 60L/16G	Stainless Steel	16	14.76	14.76	30.35
FGSC14EPLTBK	Square Open Top 60L/16G	Textured Black	16	14.76	14.76	30.35
FGSC14SSPL	Square Open Top 60L/16G	Stainless Steel	16	14.76	14.76	30.35
FGSC18EPLSM	Square Open Top 75L/20G	Stardust Silver Metallic	20	18.39	18.39	30.35
FGSC18SSPL	Square Open Top 75L/20G	Stainless Steel	20	18.39	18.39	30.35
FGSC18EPLTBK	Square Open Top 75L/20G	Textured Black	20	18.39	18.39	30.35
FGSR18EPLSM	Large Rectangle 85L/22.5G	Stardust Silver Metallic	22.5	24.02	12.01	30.35
FGSR18SSPL	Large Rectangle 85L/22.5G	Stainless Steel	22.5	24.02	12.01	30.35
FGSR18EPLTBK	Large Rectangle 85L/22.5G	Textured Black	22.5	24.02	12.01	30.35
FGDCR24CSM	Square Recycle With Bottles/Cans Lid/Label 109L/29G	Stardust Silver Metallic	29	18.39	18.39	32.20
FGDCR24TSM	Square Recycle With Landfill Lid/Label 109L/29G	Stardust Silver Metallic	29	18.39	18.39	32.20
FGSC22EPLSM	Square Open Top 151L/40G	Stardust Silver Metallic	40	21.73	21.73	30.35
FGSC22SSPL	Square Open Top 151L/40G	Stainless Steel	40	21.73	21.73	30.35
FGSC22EPLTBK	Square Open Top 151L/40G	Textured Black	40	21.73	21.73	30.35

UTILITY REFUSE
AND RECYCLING

DECORATIVE REFUSE

CLEANING

MATERIAL HANDLING

WASHROOM

FOODSERVICE

ACCESSORIES
& INDEX



Defenders®

The Defenders® decorative refuse container is an ideal indoor waste receptacle for hospitals, doctors' offices and other healthcare facilities. The step-on foot pedal enables hands-free operation, optimizing sanitary efforts.

- Restraint mechanism protects walls
- Smooth Surfaces are Easy to Clean
- Leak-proof Rigid Plastic Liner Contains Liquids and Keeps The Surrounding Area Cleaner



FGST24EPLRD



SKU #	DESCRIPTION	COLOR	GALLONS	LENGTH	WIDTH	HEIGHT
FGST7EPLRD	Square Step Can 26L/7G	Red Gloss	4	13.50	14.25	17.63
FGST7EPLWH	Square Step Can 26L/7G	Sky White Gloss	4	13.50	14.25	17.63
FGST7SSPL	Square Step Can 26L/7G	Stainless Steel	4	13.50	14.25	17.63
FGST12EPLWH	Square Step Can 45L/12G	Sky White Gloss	6.5	13.50	14.25	23.63
FGST12EPLRD	Square Step Can 45L/12G	Red Gloss	6.5	13.50	14.25	23.63
FGST12SSPL	Square Step Can 45L/12G	Stainless Steel	6.5	13.50	14.25	23.63
FGST24EPLWH	Square Step Can 90L/24G	Sky White Gloss	13	16.00	16.75	30.63
FGST24SSPL	Square Step Can 90L/24G	Stainless Steel	13	16.00	16.75	30.63
FGST24EPLRD	Square Step Can 90L/24G	Red Gloss	13	16.00	16.75	30.63
FGST40EPLRD	Square Step Can 151L/40G	Red Gloss	25	20.00	21.13	30.63
FGST40EPLWH	Square Step Can 151L/40G	Sky White Gloss	25	20.00	21.13	30.63
FGST40SSPL	Square Step Can 151L/40G	Stainless Steel	25	20.00	21.13	30.63

 BIOHAZARD PELIGRO BIOLÓGICO FGCL1*	SOILED LINEN ROPA SUCIA FGCL2*	TRASH ONLY BASURA SOLAMENTE FGCL3*	INFECTIOUS WASTE BASURA INFECCIOSA FGCL4*
--	--------------------------------------	--	---

Medical Waste Labels

SKU #	DESCRIPTION	DIMENSIONS	PACK SIZE
FGCL1	English/Spanish Label "Biohazard"	10.00" w x 7.00" h	1
FGCL2	English/Spanish Label "Soiled Linen"	10.00" w x 4.00" h	1
FGCL3	English/Spanish Label "Trash Only"	10.00" w x 4.00" h	1
FGCL4	English/Spanish Label "Infectious Waste"	10.00" w x 4.00" h	1



FGST40EPLWH

When ordering products with **BOLD** color codes, please specify color code after the product number. Refer to the Standard Color Guide at the back of the catalog.

UTILITY REFUSE
AND RECYCLING

DECORATIVE REFUSE

CLEANING

MATERIAL HANDLING

WASHROOM

FOODSERVICE

ACCESSORIES
& INDEX

Round Tops

The Round Tops decorative refuse container has a sleek design that beautifully blends into any indoor environment. These containers feature a bottom rim that is designed to protect flooring.

- The push door style features a self-closing push door to help control odor



Open Top
FGR32SSSGL

Dome Top
FGR1536EOTPLBK

Push Door"
FGR1536EPLWH

SKU #	DESCRIPTION	COLOR	LINER TYPE	GALLONS	LENGTH	WIDTH	HEIGHT
FGR1536EGLBK	Push Door 56L/15G	Black Gloss	Galvanized	15	15.00	15.00	35.84
FGR1536EPLBK	Push Door 56L/15G	Black Gloss	Plastic	15	15.00	15.00	35.84
FGR1536SSSGL	Push Door 56L/15G	Stainless Steel	Galvanized	15	15.00	15.00	35.84
FGR1536SSSPL	Push Door 56L/15G	Stainless Steel	Plastic	15	15.00	15.00	35.84
FGR1536MCPL	Push Door 56L/15G	Mirror Chrome	Plastic	15	15.00	15.00	35.84
FGR1536MCGL	Push Door 56L/15G	Mirror Chrome	Galvanized	15	15.00	15.00	35.84
FGR1536EOTGLBK	Dome Top/56L/115G	Black Gloss	Galvanized	15	15.00	15.00	33.86
FGR1536EOTPLBK	Dome Top/56L/115G	Black Gloss	Plastic	15	15.00	15.00	33.86
FGR32EGLBK	Open Top 56L/15G	Black Gloss	Galvanized	15	15.00	15.00	31.10
FGR32SSSGL	Open Top 56L/15G	Stainless Steel	Galvanized	15	15.00	15.00	31.10
FGR32MCGL	Open Top 56L/15G	Mirror Chrome	Galvanized	15	15.00	15.00	31.10
FGR32EGLWH	Open Top 56L/15G	Sky White Gloss	Galvanized	15	15.00	15.00	31.10
FGR1536EPLWH	Push Top 56L/15G	Sky White Gloss	Plastic	15	15.00	15.00	35.84
FGR1536EGLWH	Push Top 56L/15G	Sky White Gloss	Galvanized	15	15.00	15.00	35.84

Crowne

The Crowne decorative refuse indoor container has an attractive contemporary design with a curved open top that prevents objects from being placed on top of the can, keeping a neater overall appearance.

- Base of receptacle is designed to protect floors
- Receptacles have a large opening for easy waste disposal
- Includes rigid plastic liner



FGAOT15BKPL

SKU #	DESCRIPTION	COLOR	GALLONS	LENGTH	WIDTH	HEIGHT
FGAOT15SAPL	Open Top 45L/12G	Satin Aluminum	12	15.00	15.00	30.00
FGAOT15BKPL	Open Top 45L/12G	Black Gloss	12	15.00	15.00	30.00
FGAOT30SAPL	Open Top 113L/30G	Satin Aluminum	30	20.00	20.00	34.50
FGAOT30BKPL	Open Top 113L/30G	Black Gloss	30	20.00	20.00	34.50

UTILITY REFUSE
AND RECYCLING

DECORATIVE REFUSE

CLEANING

MATERIAL HANDLING

WASHROOM

FOODSERVICE

ACCESSORIES
& INDEX

Half Rounds

The Half Rounds Series decorative refuse container fits flush against walls to conserve space. The sleek and functional design of this receptacle blends seamlessly with upscale and modern indoor facilities.

- Bottom rim is designed to protect floors
- Includes rigid plastic liner



ADA COMPLIANT



Flat Top
FGSO820PLANT

Ash/Trash
FGSO8SUSSSPL

Open Top
FGSH12SSPL

SKU #	DESCRIPTION	COLOR	GALLONS	LENGTH	WIDTH	HEIGHT
FGSO8SSSPL	Flat Top 34L/9G	Stainless Steel	9	8.80	17.60	32.50
FGSO820PLBK	Flat Top 34L/9G	Black Gloss W/ Chrome Trim	9	8.80	17.60	32.50
FGSO820PLANT	Flat Top 34L/9G	Anthracite Metallic W/ Chrome Trim	9	8.80	17.60	32.50
FGSO8SUSSSPL	Ash/Trash 34L/9G	Stainless Steel	9	8.80	17.60	33.00
FGSO8SU20PLBK	Ash/Trash 34L/9G	Black Gloss W/ Chrome Trim	9	8.80	17.60	33.00
FGSH12SSPL	Open Top 45L/12G	Stainless Steel	12	8.80	17.60	32.40
FGSO12SSSPL	Open Top 45L/12G	Stainless Steel	12	8.80	17.60	32.50
FGSO1220PLBK	Open Top 45L/12G	Black Gloss W/ Chrome Trim	12	8.80	17.60	32.50
FGSH12EPLSM	Open Top 45L/12G	Stardust Silver Metallic	12	8.80	17.60	32.40
FGSH12EPLTBK	Open Top 45L/12G	Textured Black	12	8.80	17.60	32.40

Metallic Series

The Metallic Series decorative refuse container has a sleek design that blends nicely with upscale interiors.

- A protective vinyl trim is applied to the disposal opening of the Flat Top and Ash/Trash containers to help withstand the rigors of everyday use
- Bottom rim designed to protect floors
- Flat top style has a large opening for easy waste disposal
- Includes galvanized liner



ADA COMPLIANT



CSFM



Ash/Trash
FGSO16SUSSSGL

Open Top
FGCC16SSSGL

Flat Top
FGSO16SSSGL

SKU #	DESCRIPTION	COLOR	GALLONS	LENGTH	WIDTH	HEIGHT
FGSO16SSSGL	Flat Top 45L/12G	Satin Stainless Steel	12	15.00	15.00	35.84
FGSO16SUSSSGL	Ash/Trash 45L/12G	Satin Stainless Steel	12	15.00	15.00	28.52
FGCC16SSSGL	Open Top 56L/15G	Satin Stainless Steel	15	15.00	15.00	27.95

Atrium®

Durable and corrosion-resistant, the Atrium® decorative refuse indoor container has a clean, classic look. Exterior surfaces are highly polished for a smooth and blemish-free appearance.

- Designed to conceal and securely hold liner bags



ADA COMPLIANT



FGAOT35SAGL

SKU #	DESCRIPTION	COLOR	GALLONS	LINER TYPE	LENGTH	WIDTH	HEIGHT
FGAOT35SAGL	Open Top 79L/21G	Satin Aluminum	21	Galvanized	18.00	18.00	32.00
FGAOT35SAPL	Open Top 79L/21G	Satin Aluminum	21	Plastic	18.00	18.00	32.00
FGAOT35SA	Open Top 132L/35G	Satin Aluminum	35	-	18.00	18.00	32.00
FG907900HSILV	Open Top 132L/35G	Silver	35	-	18.00	18.00	32.00
FGAOT62SAPL	Open Top 208L/55G	Satin Aluminum	55	Plastic	24.00	24.00	35.00
FGAOT62SA	Open Top 234L/62G	Satin Aluminum	62	-	24.00	24.00	35.00

Slim Jim® Step-On Containers

Step-On containers are the smart choice for large-capacity, hands-free waste collection. Attractive design is suitable for front- and back-of-house applications.

- Includes rigid plastic liner



OSHA OBRA



Stainless Steel Step-On Containers

NO.	COLOR	DESCRIPTION	GALLONS	U.S. DIMENSIONS	U.S. SHIP WT/CTN	METRIC DIMENSIONS	METRIC CAPACITY	METRIC SHIP WT/CTN	PACK
1901982	Stainless Steel	Stainless Steel Front Step	4	15.6" l x 11.9" w x 15.7" h	9.6 lb	396 mm x 302 mm x 400 mm	15 L	4.364 kg	1
1901985	Stainless Steel	Stainless Steel Front Step	8	16.8" l x 12.8" w x 21.9" h	13.0 lb	427 mm x 326 mm x 555 mm	30 L	5.909 kg	1
1901987	Stainless Steel	Stainless Steel Front Step with Dual Liner	8	16.8" l x 12.8" w x 21.9" h	13.4 lb	427 mm x 326 mm x 555 mm	30 L	6.091 kg	1
1901992	Stainless Steel	Stainless Steel Front Step	13	18.1" l x 13.7" w x 28.7" h	17.7 lb	460 mm x 348 mm x 728 mm	50 L	8.045 kg	1
1901994	Stainless Steel	Stainless Steel Front Step with Dual Liner	13	18.1" l x 13.7" w x 28.7" h	19.1 lb	460 mm x 348 mm x 728 mm	50 L	8.682 kg	1
1901993	Stainless Steel	Stainless Steel End Step	13	22.7" l x 11.6" w x 28.9" h	17.8 lb	576 mm x 295 mm x 733 mm	50 L	8.091 kg	1
1901999	Stainless Steel	Stainless Steel Front Step	24	21.8" l x 16.2" w x 31.8" h	24.0 lb	553 mm x 412 mm x 808 mm	90 L	10.909 kg	1
1902001	Stainless Steel	Stainless Steel Front Step with Dual Liner	24	21.8" l x 16.2" w x 31.8" h	25.4 lb	553 mm x 412 mm x 808 mm	90 L	11.545 kg	1
1902000	Stainless Steel	Stainless Steel End Step	24	27.2" l x 13.1" w x 32.8" h	26.0 lb	690 mm x 333 mm x 834 mm	90 L	11.818 kg	1



Metal Waste Stream Labels

Choose between ten expert-designed waste stream labels that feature colors, icons, and visual cues proven to improve recycling rates.

Colored Labels



Discreet Labels



Colored Waste Stream Labels

SKU #	DESCRIPTION	DIMENSIONS	PACK SIZE
1987863	Landfill Label	10.01" w x 2.56" h	1
1988003	Plastic Label	10.01" w x 2.56" h	1
1988011	Compost Label	10.01" w x 2.56" h	1
1988009	Organic Waste Label	10.01" w x 2.56" h	1
1987867	Paper Label	10.01" w x 2.56" h	1
1988001	Cans Label	10.01" w x 2.56" h	1
1988005	Bottles/Cans Label	10.01" w x 2.56" h	1
1987865	Trash Label	10.01" w x 2.56" h	1
1987869	Mixed Recycling Label	10.01" w x 2.56" h	1
1988007	Glass Label	10.01" w x 2.56" h	1

Discreet Waste Stream Labels

SKU #	DESCRIPTION	DIMENSIONS	PACK SIZE
1988023	Plastic Label	6.88" w x 1.73" h	1
1988015	Trash Label	6.88" w x 1.73" h	1
1988021	Cans Label	6.88" w x 1.73" h	1
1988017	Paper Label	6.88" w x 1.73" h	1
1988031	Compost Label	6.88" w x 1.73" h	1
1988027	Glass Label	6.88" w x 1.73" h	1
1988019	Mixed Recycling Label	6.88" w x 1.73" h	1
1988025	Bottles/Cans Label	6.88" w x 1.73" h	1
1988029	Organic Waste Label	6.88" w x 1.73" h	1
1988013	Landfill Label	6.88" w x 1.73" h	1

When ordering products with **BOLD** color codes, please specify color code after the product number. Refer to the Standard Color Guide at the back of the catalog.

Eclipse

With its exclusive curved top, the Eclipse decorative refuse container offers a stylish addition to any contemporary décor.

- Designed with a curved top to prevent the placement of objects on the top edge
- Includes rigid plastic liner



FGR2030EPLBK

SKU #	DESCRIPTION	COLOR	GALLONS	LENGTH	WIDTH	HEIGHT
FGR2030SSPL	Eclipse Open Top Metal Refuse	Stainless Steel	30	20.00"	20.00"	33.50"
FGR2030EPLBK	Eclipse Open Top Metal Refuse	Black Gloss	30	20.00"	20.00"	33.50"

Marshal® Classic Containers

Practical good looks combined with fire safety.

- Includes retainer hardware for securing and concealing can liners
- Textured finish minimizes the appearance of surface scratches



FG816088BEIG

FG817088BLA

FG816088OWHT

Marshal® Classic Containers

NO.	COLOR	DESCRIPTION	CAPACITY (GAL)	CAPACITY (LITERS)	U.S. DIMENSIONS	U.S. SHIP WT/CTN	METRIC DIMENSIONS	METRIC SHIP WT/CTN
FG816088*1	BEIG, BLA, BRN, OWHT	Marshal® Classic Container	15	56.8	15.38" dia x 36.5" h	20.1 lb	39.1 cm dia x 92.7 cm	9.1 kg
FG817088*1	BEIG, BLA, BRN, OWHT	Marshal® Classic Container	25	94.6	18" dia x 42" h	23.0 lb	45.7 cm dia x 106.7 cm	10.4 kg
FG355000	GRAY	Rigid Liner for FG816088 Container	12½	45.9 L	12" dia x 27.25" h	16.2 lb	30.5 cm dia x 69.2 cm	7.3 kg
FG355200	GRAY	Rigid Liner with Rim for FG817088 Container	22	83.3 L	14.5" dia x 30.13" h	26.9 lb	36.8 cm dia x 76.5 cm	12.2 kg

Beige (BEIG), Black (BLA), Brown (BRN), Off White (OWHT) *1FM-Approved

UTILITY REFUSE AND RECYCLING

DECORATIVE REFUSE

CLEANING

MATERIAL HANDLING

WASHROOM

FOODSERVICE

ACCESSORIES & INDEX



Aspen

The Aspen decorative refuse container's stone panels naturally blend this receptacle into any outdoor environment.

- Durable powder coat finish withstands severe weather and resists fading even when exposed to harsh UV rays
- Hinged lid style enables easy waste removal
- Adjustable leg levelers create stability on uneven surfaces
- Includes rigid plastic liner



ADA COMPLIANT



Hinged Top
FGR36HT201PL



Ash/Trash
FGR12SU201PL

SKU #	DESCRIPTION	COLOR	GALLONS	LENGTH	WIDTH	HEIGHT
FGR12SU201PL	Ash/Trash 45L/12G	Brown Gloss Trim W/ Brown Panels	12	13.50	13.50	32.00
FGR18SU201PL	Ash/Trash 90L/24G	Brown Gloss Trim W/ Brown Panels	24	18.00	18.00	32.00
FGR36HT201PL	Hinged Top 109L/29G	Brown Gloss Trim W/ Brown Panels	29	21.00	21.00	40.00
FGR38HT201PL	Hinged Top 143L/38G	Brown Gloss Trim W/ Brown Panels	38	26.00	26.00	40.00
FGR48HT201PL	Hinged Top 181L/48G	Brown Gloss Trim W/ Brown Panels	48	26.00	26.00	40.00

Dimension

The Dimension decorative refuse container's perforated steel panels create an upscale, dimensional look that complements contemporary outdoor environments.

- Durable powder coat finish withstands severe weather and resists fading even when exposed to harsh UV rays
- Hinged lid style enables easy waste removal
- Adjustable leg levelers create stability on uneven surfaces
- Includes rigid plastic liner



ADA COMPLIANT



Hinged Top
FGR38HT500PL



Ash/Trash with
Weather Shield
FGR18WU500PL

SKU #	DESCRIPTION	COLOR	GALLONS	LENGTH	WIDTH	HEIGHT
FGR18WU500PL	Ash/Trash Weather Shield 90L/24G	Black Gloss W/ Anthracite Metallic Perf Panels	24	18.00	18.00	35.00
FGR36HT500PL	Hinged Top 109L/29G	Black Gloss W/ Anthracite Metallic Perf Panels	29	21.00	21.00	40.00
FGR38HT500PL	Hinged Top 143L/38G	Black Gloss W/ Anthracite Metallic Perf Panels	38	26.00	26.00	40.00
FGR48HT500PL	Hinged Top 181L/48G	Black Gloss W/ Anthracite Metallic Perf Panels	48	26.00	26.00	40.00

Americana Series™

The Americana Series™ offers rugged steel with multiple layers of powder coating to ensure years of trouble-free outdoor use.

- Adjustable leg levelers for stability on uneven surfaces
- Extremely heavy to deter theft and withstand harsh weather conditions



FGMT32PLABZ

SKU #	COLOR	DESCRIPTION	GALLONS	LENGTH	WIDTH	HEIGHT
FGMT22	Architectural Bronze (PLABZ) Black (PLBK)	Americana Series™ Open Top	24	25.5	25.5	25.5
FGMT32	Architectural Bronze (PLABZ) Black (PLBK) Green (PLVSGN)	Americana Series™ Open Top	36	29	29	32.5

Atrium® Classic Containers

Attractive open top containers for hygienic waste disposal.

- FG905800 combines the durability of plastic, a hands-free funnel top, and the fire protection of a closed top
- Heavy-duty plastic construction with molded-in color and UV inhibitors
- Textured finish helps minimize appearance of surface scratches
- Built-in side handles ease lifting
- FG905800 is FM-Approved



FG905800BLA

Atrium® Classic

NO.	COLOR	DESCRIPTION	U.S. DIMENSIONS	U.S. CAPACITY	U.S. SHIP WT/CTN	CAN LINERS	PACK
FG905800*	BLA	Atrium® Classic Container with Funnel Top	25" dia x 33.3" h	35 gal	23.5 lb	5008-88 ^a	1
FG905886	WGRAN	Atrium® Classic Container with Funnel Top	25" dia x 33.3" h	35 gal	23.5 lb	5008-88 ^a	1

^aNot for sale in California.



FGR48HTWU500PL



**Landmark Series®
Classic Containers**

High-volume refuse collection and smoking management for indoor and outdoor areas, including building entrances, lobbies, and malls.

- Choose Dome Top model for outdoor use or Funnel Top model for indoor use
- Tops are hinged and include a stay-open strap for easy access to rigid liner
- Ash/Trash models include metal sand pan and large refuse openings
- Locking Dome Top model (FG397088) provides added security



UTILITY REFUSE
AND RECYCLING

DECORATIVE REFUSE

CLEANING

MATERIAL HANDLING

WASHROOM

FOODSERVICE

ACCESSORIES
& INDEX

STEP 1: CHOOSE FRAME STYLE, SIZE, AND COLOR

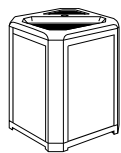

**FUNNEL TOP
ASH/TRASH
CONTAINER**
Available in 20G and
35G in Sable and
Dark Wood



FUNNEL TOP
Available in 20G and
35G in Sable

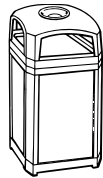

**DOME TOP
ASH/TRASH
CONTAINER**
Available in 35G and
50G in Sable, Dark
Wood, and Black

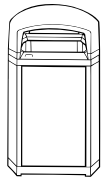

DOME TOP
Available in 35G and
50G in Sable, Dark
Wood, and Black

STEP 2: CHOOSE PANELS (4 PANELS PER UNIT)

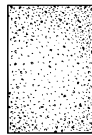

FG400200
Fits 20-Gal Landmark Series®
Containers



Coral **River Rock**
CORL ROCK

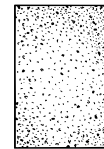

FG400300
Fits 35-Gal Landmark Series®
Containers



Brown Stone **Coral** **River Rock**
BSTON CORL ROCK

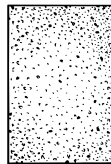

FG400400
Fits 50-Gal Landmark Series®
Containers



Brown Stone **Coral** **River Rock**
BSTON CORL ROCK

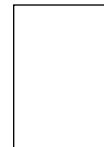

FG400600
Clear Panel for FG397000,
FG397001, FG397088, FG397100,
FG397200 Containers

Landmark Series® Frames

NO.	COLOR	DESCRIPTION (W/O PANELS)	CAPACITY (GAL)	CAPACITY (LITERS)	U.S. DIMENSIONS	U.S. SHIP WT/CTN	METRIC DIMENSIONS	METRIC SHIP WT/CTN
FG396600	SBLE, DWOOD	Landmark Series® Classic Container, Ash/Trash Frame with FG356988 Rigid Liner	20	75.7	21" sq x 30.5" h	32.8 lb	53.3 cm sq x 77.5 cm	14.9 kg
FG396700	SBLE	Landmark Series® Classic Container, Funnel Top Frame with FG356988 Rigid Liner	20	75.7	21" sq x 30.5" h	33.6 lb	53.3 cm sq x 77.5 cm	15.2 kg
FG397000	SBLE, DWOOD, BLA	Landmark Series® Classic Container, Dome Top Frame with FG395800 Rigid Liner	35	132.5	26" sq x 40" h	49.6 lb	66 cm sq x 101.6 cm	22.5 kg
FG397001	SBLE, DWOOD, BLA	Landmark Series® Classic Container, Dome Top with Ash Tray, Frame and FG395800 Rigid Liner	35	132.5	26" sq x 40" h	51.6 lb	66 cm sq x 101.6 cm	23.4 kg
FG397088	BLA	Landmark Series® Classic Container, Dome Top Frame with Lock Option, with FG395800 Rigid Liner	35	132.5	26" sq x 40" h	48.9 lb	66 cm sq x 101.6 cm	22.2 kg
FG397100	SBLE, DWOOD	Landmark Series® Classic Container, Ash/Trash Frame with FG395800 Rigid Liner	35	132.5	26" sq x 30.5" h	43.4 lb	66 cm sq x 77.5 cm	19.7 kg
FG397200	SBLE	Landmark Series® Classic Container, Funnel Top Frame with FG395800 Rigid Liner	35	132.5	26" sq x 30.5" h	43.0 lb	66 cm sq x 77.5 cm	19.5 kg
FG397500	SBLE, DWOOD, BLA	Landmark Series® Classic Container, Dome Top Frame with FG395900 Rigid Liner	50	189.3	26" sq x 46.5" h	55.5 lb	66 cm sq x 118.1 cm	25.2 kg
FG397501	SBLE, DWOOD, BLA	Landmark Series® Classic Container, Dome Top with Ash Tray, Frame and FG395900 Rigid Liner	50	189.3	26" sq x 46.5" h	58.2 lb	66 cm sq x 118.1 cm	26.4 kg

Landmark Series® Panels (Sold Separately)

NO.	COLOR	DESCRIPTION (W/O PANELS)
FG400200	CORL, ROCK	20G Landmark Series® Panel for FG396600 and FG396700
FG400300	BSTON, CORL, ROCK	35G Landmark Series® Panel for FG397000, FG397001, FG397088, FG397100, FG397200
FG400400	BSTON, CORL, ROCK	50G Landmark Series® Panel for FG397500, FG397501
FG400600	CLR	35G Clear Panel for FG397000, FG397001, FG397088, FG397100, FG397200 Containers

When ordering products with **BOLD** color codes, please specify color code after the product number. Refer to the Standard Color Guide at the back of the catalog.

Landmark Series® Security Container

The solution for secure, effective, and affordable waste management for outdoor use.

- Complies with Department of Homeland Security Directive SD RAILPAX-04-01
- Provides total visibility of contents for improved security
- Constructed of durable, chemical-resistant, engineered polymer for easy cleaning and long life
- Locking dome top and bolt-down capability for added security
- Can liner retainer band for easy servicing
- No assembly required



ADA COMPLIANT



Polyliner retainer band for easy servicing.



Quick bag attachment and removal.



Panels are replaceable for extended life.

FG397589 and FG400700 are ideal for security-conscious facilities such as airports, train stations, sports facilities, government and office complexes, and convention centers.



FG397589BLA / FG400700BLA

Landmark Series® Security Container

NO.	COLOR	DESCRIPTION	CAPACITY (GAL)	CAPACITY (LITERS)	U.S. DIMENSIONS	U.S. SHIP WT/CTN	METRIC DIMENSIONS	METRIC SHIP WT/CTN
FG397589	BLA	Landmark Series® Security Container with Lock and Clear Panels	50	189.3	26" sq x 46.5" h	62.4 lb	66 cm sq x 118.1 cm	28.3 kg
FG400700	CLR	Clear Replacement Panel for FG397500, FG397501, FG397589 Containers	N/A	N/A	20.5" l x 34" w x 2.75" h	17.7 lb	52.1 cm x 86.4 cm x 7 cm	8 kg

Black (BLA), Clear (CLR)

Landmark Series® Gas Station/Store Front Containers

Style combined with functionality helps make gas islands and store fronts appealing and efficient for outdoor use.

- Landmark Series® models integrate waste management and window washing
- Insert personal messages and advertising with panel frame models (FG9W0200, FG9W0300)
- Standard bolt-down base for stability
- FG9W1400 provides an affordable funnel-top container for stadiums, retail, education, and hospitality environments



ADA COMPLIANT



FG9W0200BLA/FG9W0400BLA

Display your own custom insert to promote special messages right at the pump.



Dome Top FG9W0300BLA

Funnel Top FG9W0200BLA

Landmark Series® Gas Station/Store Front Containers

NO.	COLOR	DESCRIPTION	CAPACITY (GAL)	CAPACITY (LITERS)	U.S. DIMENSIONS	U.S. SHIP WT/CTN	METRIC DIMENSIONS	METRIC SHIP WT/CTN
FG9W0000	BLA	Landmark Series® Standard Funnel Top	35	132.5	24" sq x 31" h	28.2 lb	61 cm sq x 78.7 cm	12.8 kg
FG9W0100	BLA	Landmark Series® Standard Dome Top	35	132.5	24" sq x 43" h	31.0 lb	61 cm sq x 109.2 cm	14.1 kg
FG9W0200	BLA	Landmark Series® Funnel Top with Panel Frame and FG395800 Rigid Liner	35	132.5	24" sq x 31" h	30.2 lb	61 cm sq x 78.7 cm	13.7 kg
FG9W0300	BLA	Landmark Series® Dome Top with Panel Frame and FG395800 Rigid Liner	35	132.5	24" sq x 43" h	33.0 lb	61 cm sq x 109.2 cm	15 kg

Black (BLA)

Landmark Series® Accessory (Sold Separately)

NO.	COLOR	DESCRIPTION	CAPACITY (GAL)	CAPACITY (LITERS)	U.S. DIMENSIONS	U.S. SHIP WT/CTN	METRIC DIMENSIONS	METRIC SHIP WT/CTN
FG9W0400	BLA	Window Wash Kit for FG9W0000, FG9W0100, FG9W0200, FG9W0300 Containers	N/A	N/A	6.25" l x 16.25" w x 30" h	8.2 lb	15.9 cm x 41.3 cm x 76.2 cm	3.7 kg

Black (BLA)

For Additional Rigid Liner Options See Page 258



Ranger®

Ranger® waste containers feature Rubbermaid's famous durability, modern styling, and easy-to-service design for outdoor use.

- Designed for stadiums, parks, shopping malls, and other high-traffic areas
- Permanently attached hinged lid for easy emptying
- Pedestal base ring on 45-gallon and 65-gallon containers for stability and security (to be filled with sand or water by customer)



ADA COMPLIANT



APPROVED



FG917600BLA

FG917188BLA

FG843088BEIG



BETTER LINER RETENTION

Metal retainers keep can liners securely in place and eliminate knot tying.

LID OPTIONS

Ranger® 45- and 65-gallon containers are available in two styles:

2 HINGED DOORS for waste concealment and odor control.

4 OPENINGS for easier access in high-traffic areas.



WEIGHTED BASE OPTION

Optional Weighted Base (FG917700) is secured with screws and is available for 45- and 65-Gallon Ranger® containers for added stability. To be filled with sand or water by customer.



ENHANCED DURABILITY

Ranger® lids feature integrated, durable hinges that keep the lid securely attached to the container during emptying.



FG917500BEIG

Ranger®

NO.	COLOR	DESCRIPTION	CAPACITY (GAL)	CAPACITY (LITERS)	U.S. DIMENSIONS	U.S. SHIP WT/CTN	METRIC DIMENSIONS	METRIC SHIP WT/CTN
FG843088 ¹	BLA, BEIG	35-Gallon Ranger® Container	35	132.5	21.5" sq x 41" h	30.4 lb	54.6 cm sq x 104.1 cm	13.8 kg
FG917188 ¹	BLA, BEIG	45-Gallon Ranger® Container with 2 Doors	45	170.3	24.88" sq x 41.5" h	42.5 lb	63.2 cm sq x 105.4 cm	19.3 kg
FG917388 ¹	BLA, BEIG	45-Gallon Ranger® Container with 4 Openings	45	170.3	24.88" sq x 41.5" h	37.9 lb	63.2 cm sq x 105.4 cm	17.2 kg
FG917500 ¹	BLA, BEIG	65-Gallon Ranger® Container with 2 Doors	65	246.1	24.88" sq x 49.25" h	51.1 lb	63.2 cm sq x 125.1 cm	23.2 kg
FG917600 ¹	BLA, BEIG	65-Gallon Ranger® Container with 4 Openings	65	246.1	24.88" sq x 49.25" h	46.5 lb	63.2 cm sq x 125.1 cm	21.1 kg
FG917700 ¹	BLA, BEIG	Weighted Base Accessory for 45- and 65-Gallon Ranger® Containers	N/A	N/A	24.5" sq x 6" h	8.5 lb	62.2 cm sq x 15.2 cm	3.9 kg
FG395800	GRAY, BEIG	Untouchable® Square Container (liner for FG917188/FG917388)	35	132.5	19.5" sq x 27.63" h	39.4 lb	49.5 cm sq x 70.2 cm	17.9 kg
FG395900	GRAY, BEIG	Untouchable® Square Container (liner for FG917500/FG917600)	50	189.3	19.5" sq x 34.25" h	53.9 lb	49.5 cm sq x 87 cm	24.4 kg
FG356600	GRAY	Rigid Liner for FG843088	24.5	93.4 L	16.25" sq x 28.5" h	33.3 lb	41.3 cm sq x 72.4 cm	15.1 kg

Beige (BEIG), Black (BLA), Brown (BRN), Gray (GRAY) ¹ Provides hands-free use.

¹FM-Approved

Plaza®

Contemporary styling with side opening door for "no lift" unloading.

- The 35-gallon size is ideal for tight spaces and ships fully assembled
- Spring-loaded swing doors help contain odors
- Includes bolt-down capability
- Textured top model accommodates up to 15" x 20" (38.1 cm x 50.8 cm) trays
- Models FG396300, FG396400, and FG9P9000 are Factory Mutual (FM) approved when used with FG395800 and FG356300 Rigid Liners, respectively



FG396500* and FG9P9100* include a convenient ash tray insert.



FG396500BEIG*



FG9P9000BLA*
The 35-gallon size is ideal for tight spaces.



Plaza®

NO.	COLOR	DESCRIPTION	CAPACITY (GAL)	CAPACITY (LITERS)	U.S. DIMENSIONS	U.S. SHIP WT/CTN	METRIC DIMENSIONS	METRIC SHIP WT/CTN
FG396300 ¹	BLA, BEIG	Plaza® Container with Tray Top	50	189.3	24.75" l x 25.25" w x 43" h	81.0 lb	62.9 cm x 64.1 cm x 109.2 cm	36.7 kg
FG396400 ¹	DGRN, BLA, BEIG	Plaza® Container	50	189.3	24.75" l x 25.25" w x 42.13" h	78.0 lb	62.9 cm x 64.1 cm x 107 cm	35.4 kg
FG396500*	BEIG	Plaza® Container with Ash Tray	50	189.3	24.75" l x 25.25" w x 42.13" h	78.0 lb	62.9 cm x 64.1 cm x 107 cm	35.4 kg
FG396873	BLUE	Plaza® Bottle and Can Recycling Container	50	189.3 L	24.75" l x 25.25" w x 42.13" h	78.0 lb	62.9 cm x 64.1 cm x 107 cm	35.4 kg
FG9P9000 ¹	DGRN, BLA, BEIG	Plaza® Jr. Container	35	132.5	21.4" l x 20.3" w x 41.1" h	51.8 lb	54.4 cm x 51.6 cm x 104.4 cm	23.5 kg
FG9P9100*	BLA	Plaza® Jr. Container with Ash Tray Top	35	132.5	21.4" l x 20.3" w x 41.1" h	53.6 lb	54.4 cm x 51.6 cm x 104.4 cm	24.3 kg
FG356300	BEIG	Rigid Liner for FG9P9000 and FG9P9100 Containers	19	71.9	14.2" sq x 28" h	27.0 lb	36.1 cm sq x 71.1 cm	12.2 kg
FG395800 ¹	GRAY, BEIG	Untouchable® Square Container (liner for FG396500)	35	132.5	19.5" sq x 27.63" h	39.4 lb	49.5 cm sq x 70.2 cm	17.9 kg

Beige (BEIG), Black (BLA), Dark Green (DGRN), Gray (GRAY)

*Does not include rigid liner. ¹ FM-Approved

UTILITY REFUSE AND RECYCLING

DECORATIVE REFUSE

CLEANING

MATERIAL HANDLING

WASHROOM

FOODSERVICE

ACCESSORIES & INDEX

Street Baskets

Designed to withstand constant use and harsh weather conditions. See-through design is ideal for city streets, parks, beaches, and other high-traffic areas.

- All-weather corrosion-resistant material
- Easy to transport and store
- Drain holes allow rain runoff
- Anchoring kits available to prevent tipping or theft



ADA COMPLIANT

Shown with optional Drum Top
FG1855BK



FGSBR52BK

Street Baskets

NO.	COLOR	DESCRIPTION	CAPACITY (GAL)	CAPACITY (LITERS)	U.S. DIMENSIONS	U.S. SHIP WT/CTN	METRIC DIMENSIONS	METRIC SHIP WT/CTN
FGSBR52	Galvanized Steel	Street Basket	45	170.3	24" dia x 33" h	41.0 lb	61 cm dia x 83.8 cm	18.6 kg
FGSBR52BK	Black	Street Basket	45	170.3	24" dia x 33" h	41.0 lb	61 cm dia x 83.8 cm	18.6 kg

Steel Drum Tops

- Self-closing "PUSH" door
- Factory Mutual-approved fire-safe/self-extinguishing when used with a steel drum; complies with OSHA standards
- Includes thumbscrews for securing cover to drum

FG1855 Fits

- 55-Gal Steel Drum
- FGSBR52 (see *Street Baskets, above*)

FG2030 Fits

- 30-Gal Steel Drum



OSHA



FG2030BK



Steel Drum Tops (Sold Separately)

NO.	COLOR	DESCRIPTION	CAPACITY (GAL)	CAPACITY (LITERS)	U.S. DIMENSIONS	U.S. SHIP WT/CTN	METRIC DIMENSIONS	METRIC SHIP WT/CTN
FG1855	BK, EGN, RD	Steel Drum Top for use w/ 55-Gal Steel Drum, FGSBR52	N/A	N/A	24.5" dia	12.0 lb	62.2 cm dia	5.4 kg
FG2030	BK, BR, EGN	Steel Drum Top for use w/ 30-Gal Steel Drum	N/A	N/A	20" dia	9.0 lb	50.8 cm dia	4.1 kg

Black (BK), Brown (BR), Empire Green (EGN), Red (RD).

Glutton®

Large-capacity containers for indoor/outdoor use.

- Perfect for large crowds and high-traffic areas
- Withstands extreme weather and handling
- Hooded top available with and without doors
- Hold-down base can be filled with sand or water to provide added stability and security



ADA COMPLIANT

FG256B00BRN* / FG256V00BRN



FG256X00RED / FG256B00OWHT



FG256V00RED

Glutton®

NO.	COLOR	DESCRIPTION	CAPACITY (GAL)	CAPACITY (LITERS)	U.S. DIMENSIONS	U.S. SHIP WT/CTN	METRIC DIMENSIONS	METRIC SHIP WT/CTN
FG256B00*	OWHT, BRN	Glutton® Container	56	212	25.5" l x 22.75" w x 31.13" h	67.3 lb	64.8 cm x 57.8 cm x 79.1 cm	30.5 kg
FG256V00	RED, BRN	Glutton® Hooded Top without doors for FG256B00 Containers	N/A	N/A	26.63" l x 23" w x 13" h	14.2 lb	67.6 cm x 58.4 cm x 33 cm	6.4 kg
FG256X00	RED, BRN	Glutton® Hooded Top with doors for FG256B00 Containers	N/A	N/A	26.63" l x 23" w x 13" h	19.2 lb	67.6 cm x 58.4 cm x 33 cm	8.7 kg
FG256K00	GRAY	Rigid Liner for Glutton® Container	42	159	23.25" l x 20.25" w x 29" h	48.1 lb	59.1 cm x 51.4 cm x 73.7 cm	21.8 kg

Brown (BRN), Off White (OWHT), Red (RED)

**Smokers' Station®
Wall Mount**

Simply snuff out cigarettes on the extinguishing screen and drop into the receptacle.

- Recessed extinguishing screen prevents ashes from falling to the ground
- Heavy-gauge, hot-dipped galvanized, powder-coated, or stainless steel
- Mounting hardware included
- Keyed camlock helps prevent tampering



Easy emptying.



Optional surface mount and in-ground poles accommodate 1 or 2 models. FGSSSM / FGSSIG

Smokers' Station® Wall Mount

NO.	COLOR	DESCRIPTION	CAPACITY (GAL)	CAPACITY (LITERS)	U.S. DIMENSIONS	U.S. SHIP WT/CTN	METRIC DIMENSIONS	METRIC SHIP WT/CTN
FGR1012	SS	Smokers' Station® Wall-Mount Urn w/ Keyed Cam Lock	N/A	N/A	10" w x 12.5" h	7.0 lb	25.4 cm x 31.8 cm	3.2 kg
FGR1012E	BK	Smokers' Station® Wall-Mount Urn w/ Keyed Cam Lock	N/A	N/A	10" w x 12.5" h	7.0 lb	25.4 cm x 31.8 cm	3.2 kg
FGSSSM		Smokers' Station® Wall-Mount/Surface-Mount Pole w/ Hardware for FGR1012	N/A	N/A	2" dia x 51" h	19.0 lb	5.1 cm dia x 129.5 cm	8.6 kg
FGSSIG		Smokers' Station® Wall-Mount In-Ground Pole w/ Hardware for FGR1012	N/A	N/A	2" dia x 69" h	21.0 lb	5.1 cm dia x 175.3 cm	9.5 kg

Black (BK), Stainless Steel (SS)

Classic Smoking Urns and Accessories

Perfect in lobbies and hallways.

- Available with side opening for Class A refuse collection
- One-piece, wall-mounted smoking urn is easy to empty and clean



Classic Smoking Urns and Accessories

NO.	COLOR	DESCRIPTION	CAPACITY (GAL)	CAPACITY (LITERS)	U.S. DIMENSIONS	U.S. SHIP WT/CTN	METRIC DIMENSIONS	METRIC SHIP WT/CTN
FG258500	BLA	Classic Smoking Urn with Metal Ash Tray Top	N/A	N/A	11.5" dia x 19.5" h	8.4 lb	29.2 cm dia x 49.5 cm	3.8 kg
FG258600	BLA	Classic Smoking Urn, Ash/Trash w/ Metal Ash Tray Top and Metal Liner	N/A	N/A	12.5" dia x 19.5" h	9.7 lb	31.8 cm dia x 49.5 cm	4.4 kg

Black (BLA)

UTILITY REFUSE AND RECYCLING

DECORATIVE REFUSE

CLEANING

MATERIAL HANDLING

WASHROOM

FOODSERVICE

ACCESSORIES & INDEX

Ash/Trash Containers

Combines waste and smoking management for increased efficiency.

CLASSIC CONTAINERS

- Ash tray can be permanently attached or left unattached for easy emptying
- Retainer hardware secures and conceals can liners
- Doors on both sides provide easy access for trash disposal



ADA COMPLIANT



Ash/Trash Classic Containers

NO.	COLOR	DESCRIPTION	CAPACITY (GAL)	CAPACITY (LITERS)	U.S. DIMENSIONS	U.S. SHIP WT/CTN	METRIC DIMENSIONS	METRIC SHIP WT/CTN
FG818088	BRN, BEIG	Ash/Trash Classic Container with Doors	25	94.6	18" dia x 42.25" h	27.7 lb	45.7 cm dia x 107.3 cm	12.6 kg
FG818288*	BEIG	Ash/Trash Classic Container without Doors	25	94.6	18" dia x 42.25" h	26.0 lb	45.7 cm dia x 107.3 cm	11.8 kg
FG818488	BEIG	Ash/Trash Classic Container with Doors	15	56.8	15.5" dia x 38" h	21.3 lb	39.4 cm dia x 96.5 cm	9.7 kg
FG818588*	BEIG	Ash/Trash Classic Container without Doors	15	56.8	12.5" dia x 38" h	19.6 lb	31.8 cm dia x 96.5 cm	8.9 kg
FG355000	GRAY	Rigid Liner for FG818488, FG818588 Containers	12.1	45.9	12" dia x 27.25" h	16.2 lb	30.5 cm dia x 69.2 cm	7.3 kg
FG355200	GRAY	Rigid Liner with Rim for FG818088 and FG818288 Containers	22	83.3	14.5" dia x 30.13" h	26.9 lb	36.8 cm dia x 76.5 cm	12.2 kg

Beige (BEIG), Brown (BRN), Gray (GRAY) *Provides hands-free use.

GroundsKeeper® Receptacles

Classic, all-weather solution to an unsightly environmental problem.

- Hygienic, easy-to-service steel canister
- Restricted opening shields waste from view, weather, and flow of oxygen
- Galvanized steel inner canister holds large quantities of cigarette waste
- Steel base plate adds stability and discourages theft
- Optional Weight Ring (FG628400) available for Safety Cones for added stability

FG257088BEIG



FG9W3000BLA

FG9W3000's Tuscan style combines clean good looks with easy maintenance.

- Design blends with many styles
- Stainless steel snuff plate
- Anchor holes for added security

GroundsKeeper®

NO.	COLOR	DESCRIPTION	CAPACITY (GAL)	CAPACITY (LITERS)	U.S. DIMENSIONS	U.S. SHIP WT/CTN	METRIC DIMENSIONS	METRIC SHIP WT/CTN
FG257088*	BRN, BLA, BEIG	GroundsKeeper® Smoking Management Receptacle	N/A	N/A	12.25" sq x 39.4" h	15.5 lb	31.1 cm sq x 100.1 cm	7 kg
FG628400	BLA	Weight Ring	N/A	N/A	12.5" l x 12.5" w x 1" h	10.0 lb	31.8 cm x 31.8 cm x 2.5 cm	4.5 kg
FG9W2900	0000	Security Kit for GroundsKeeper® Tuscan Receptacle	N/A	N/A	N/A	2.8 lb	N/A	1.3 kg
FG9W3000	BLA, SSTON	GroundsKeeper® Tuscan Receptacle	N/A	N/A	13" sq x 38.38" h	15.4 lb	33 cm sq x 97.5 cm	7 kg

Black (BLA), Beige (BEIG), Brown (BRN), Sandstone (SSTON), No Color (0000)

UTILITY REFUSE AND RECYCLING

DECORATIVE REFUSE

CLEANING

MATERIAL HANDLING

WASHROOM

FOODSERVICE

ACCESSORIES & INDEX

Infinity™ Smoking Management Solutions

Sophisticated styling and all-metal construction for attractive and efficient smoking litter management.

- High-capacity receptacles for heavy traffic areas
- Stainless steel snuff plates
- Weighted bases and bolt-down options for added stability outdoors
- 360° disposal area
- Domed tops for weather resistance
- Integrated padlock tabs provide security against tampering and theft



CSFM



Recessed extinguishing screen snuffs small butts and avoids smoldering.



Curved cap prevents items or trash being placed on the top and water from entering the canister.



Integrated padlock tabs provide security against tampering and theft.



Holes to bolt to ground help the container remain stable and add security.



FG9W3300ATPWTR



FG9W3400AGBRNZ

NO.	COLOR	DESCRIPTION	CAPACITY (GAL)	CAPACITY (LITERS)	CIGARETTE COUNT	U.S. DIMENSIONS	U.S. SHIP WT/CTN	METRIC DIMENSIONS	METRIC SHIP WT/CTN
FG9W3100	SSBLA	Infinity™ Base-Mount Smoking Receptacle	1.3	4.9	1,500*	15.5" w x 39.63" h	23.3 lb	39.4 cm x 100.7 cm	10.6 kg
FG9W3200	SSBLA	Infinity™ Wall-Mount Smoking Receptacle	0.6	2.3	700*	11.63" w x 18" h	12.0 lb	29.5 cm x 45.7 cm	5.4 kg
FG9W3300	BLA, ATPWTR, AGBRNZ	Infinity™ Traditional Smoking Receptacle	4.1	15.5	5,000*	13" w x 39" h	23.8 lb	33 cm x 99.1 cm	10.8 kg
FG9W3400	BLA, ATPWTR, AGBRNZ	Infinity™ Ultra-High-Capacity Smoking Receptacle	6.7	25.4	8,000*	15.5" w x 41.5" h	32.5 lb	39.4 cm x 105.4 cm	14.7 kg

Aged Bronze (AGBRNZ), Antique Pewter (ATPWTR), Black (BLA), Stainless Steel/Black Top (SSBLA)

*Based on estimated 1,200 cigarette butts per gallon.

UTILITY REFUSE AND RECYCLING

DECORATIVE REFUSE

CLEANING

MATERIAL HANDLING

WASHROOM

FOODSERVICE

ACCESSORIES & INDEX



Metropolitan Smokers' Station

Metropolitan is a stylish all-metal, high-capacity smokers' station.



USER-FRIENDLY
Stainless steel snuff plates on both sides of unit.

WEATHERPROOF FINISH
Long-lasting Uni-Koat® powder-coated finish.

AESTHETIC AND DURABLE
All-metal construction in a slim, contemporary design.

FGR93400SM

FGR93400BK



EASY TO EMPTY
Hinged lid flips open to provide complete access to the 1.6-gal galvanized liner. Simply lift out liner, discard waste, and reinsert.



WEIGHTED BASE AND BOLT-DOWN CAPABILITY
Base features holes for standard 3/8" lag or concrete bolts (not included) and is weighted for stability.



SECURITY FEATURES
Integrated keyed cam lock secures lid against tampering and helps reduce replacement costs.

NO.	COLOR	DESCRIPTION	CAPACITY (GAL)	CAPACITY (LITERS)	U.S. DIMENSIONS	U.S. SHIP WT/CTN	METRIC DIMENSIONS	METRIC SHIP WT/CTN
FGR93400	BK, SM	Metropolitan Smokers' Station	1.6 gallons Approx. 1,800 cigarettes	6.06 liters	16.8" dia x 42.8" h	39 lb	42.7 cm dia x 108.7 cm	17.7 kg
Black (BK), Silver Metallic (SM)								

When ordering products with **BOLD** color codes, please specify color code after the product number. Refer to the Standard Color Guide at the back of the catalog.

UTILITY REFUSE AND RECYCLING

DECORATIVE REFUSE

CLEANING

MATERIAL HANDLING

WASHROOM

FOODSERVICE

ACCESSORIES & INDEX

Smokers' Pole

Simple, space-saving solution for controlling smokers' waste.

- Easy-to-empty design requires no tools and minimal bending
- Weather-resistant, powder-coated, fire-safe aluminum
- Recessed extinguishing screen



ADA COMPLIANT



1. Remove top using quick-release push-button.



2. Detach unit at midpoint, using quick-release push-button.



3. Empty contents.



FGR1SM

FGR1BK

NO.	COLOR	DESCRIPTION	CAPACITY (GAL)	CAPACITY (LITERS)	U.S. DIMENSIONS	U.S. SHIP WT/CTN	METRIC DIMENSIONS	METRIC SHIP WT/CTN
FGR1	BK, SM	Smokers' Pole	N/A	N/A	4" dia x 12.75" w x 41" h	24.0 lb	10.2 cm dia x 32.4 cm x 104.1 cm	10.9 kg

Black (BK), Silver Metallic (SM)

Aladdin Smokers' Station®

Weather-resistant, fire-safe steel construction will not burn.

- Factory Mutual-approved fire-safe/self-extinguishing
- Oxygen-restricting design quickly extinguishes cigarettes
- Nylon base pads prevent damage to surface and base
- Stainless steel latches and nickel-plated brass chain
- Optional anchoring kits available



ADA COMPLIANT



FGR1639EHGR

FGR1639EBZ



Stainless steel latches require no tedious, time-consuming alignment to fasten. Forms a tight-fitting seal.



Top and base connected with nickel-plated brass chain to deter theft.

Aladdin Smokers' Station®

NO.	COLOR	DESCRIPTION	CAPACITY (GAL)	CAPACITY (LITERS)	U.S. DIMENSIONS	U.S. SHIP WT/CTN	METRIC DIMENSIONS	METRIC SHIP WT/CTN
FGR1639E	HBZ, HGR	Aladdin Smokers' Station®	41	170	16" dia x 38.75" h	22.0 lb	40.6 cm dia x 98.4 cm	10 kg

Hammertone Bronze (HBZ), Hammertone Charcoal (HGR)



This symbol, positioned with Decorative Receptacle refuse containers, indicates post-consumer recycled content (30% for steel, 70% for aluminum).



Waste Container Accessories



SAND
FGB25/FGS25

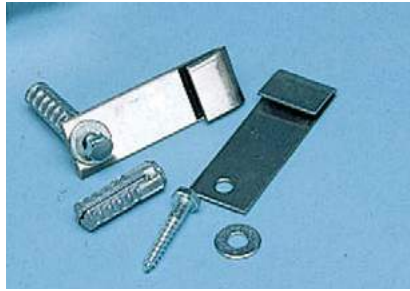

ANCHORING KIT
See chart.



Find replacement liners on page 258 or call your Rubbermaid Commercial Products' Sales Representative.

Waste Container Smoking Accessories

NO.	DESCRIPTION	FOR USE WITH:
FGB25	Black Sand, five 5-lb Bags	All Sand Urns
FGS25	White Silica Sand, five 5-lb Bags	All Sand Urns

Waste Container Anchoring Kits/Accessories

NO.	DESCRIPTION	FOR USE WITH:
FGKR12	Anchoring Kit	FGMT12, FGMT22, FGMT32
FGKR52C	Anchoring Kit (concrete)	FGSBR52
FGAB1	Anchoring Bolt	FGR12, FGR14, FGR40, FGR41

UTILITY REFUSE
AND RECYCLING

DECORATIVE REFUSE

CLEANING

MATERIAL HANDLING

WASHROOM

FOODSERVICE

ACCESSORIES
& INDEX



FGSH12EPLSM



UTILITY REFUSE
AND RECYCLING

DECORATIVE REFUSE

CLEANING

MATERIAL HANDLING

WASHROOM

FOODSERVICE

ACCESSORIES
& INDEX



CLEANING



1928756

HYGEN™ MICROFIBER

Why HYGEN™?	74
Disposable Microfiber System	75
HYGEN™ Microfiber Cloths	76
HYGEN™ Flexi-Frame	77
HYGEN™ Single-Sided Mops	78
Microfiber Damp Mops	79
HYGEN™ Quick-Connect	
Single-Sided Frames	80
HYGEN™ Quick-Connect	
Equipment	81
HYGEN™ Microfiber Buckets	82
PULSE™ Microfiber Floor	
Cleaning System with Single-Sided Frame	83
PULSE™ Microfiber Floor Cleaning	
System with Double-Sided Frame	84
Double-Sided Microfiber Mops	84
Double-Sided Frame	85
HYGEN™ Microfiber Flexible	
Dusting Wand	86
HYGEN™ Microfiber Mitts	86
HYGEN™ MICROFIBER	
HYGEN™ Sanitizer-Safe Microfiber Cloths	87
HYGEN™ Microfiber Kit	
with Charging Bucket	87
MICROFIBER	
Light Commercial Microfiber Cloths and Mops	88
FLOW™ Finishing Systems	89
Microfiber Flat Mop Finishing	90
Microfiber Finish System	90

WAVEBRAKE® MOPPING SYSTEMS

WaveBrake® Buckets and Wringers	95
WaveBrake® Institutional Bucket and Wringer	96
WaveBrake® Bucket and Casters	96
Tandem™ 31-Qt Bucket and Wringer Combo	97
WaveBrake® Wringers	97
WaveBrake® Dirty Water Buckets	97

WET MOPS

Wet Mop Selection Guide	98
-------------------------	----

MAXIMIZER™ WET MOPS

Maximizer™ Microfiber Blend Mops	102
Maximizer™ Blend Mops	102

PREMIUM WET MOPS

Web Foot® Mops	103
Web Foot® Microfiber Tube Mops	103
Web Foot® Microfiber String Mops	103
Web Foot® Blend Shrinkless® Mops	104
Web Foot® Blend Scrubbing Wet Mops	104
Web Foot® Blend Mops	104
Web Foot® Finish Mops	105
Swinger Loop® Shrinkless® Wet Mops	105
Swinger Loop® Wet Mops	105

STANDARD WET MOPS

Swinger Loop® Finish Mops	107
Super Stitch® Rayon Mops	107
Super Stitch® Cotton Scrubbing Wet Mop	107
Super Stitch® Cotton Mop	108
Super Stitch® Finish Mops	108
Super Stitch® Blend Scrubbing Wet Mop	108
Super Stitch® Blend Mops	109
Universal Headband Blue Blend Mops	109

Universal Headband Rayon Mops	109
Universal Headband Cotton Mops	110

ECONOMY WET MOPS

Dura Pro Blend Mops	110
Dura Pro Rayon Mops	110
Disposable Wet Mop	111
Dura Pro Cotton Mops	111
Value Pro Cut-End Cotton	
and Rayon Wet Mops	112
Bolt-On Cut-End Blend Mops	112
Bolt-On Cut-End Rayon Mops	112
Bolt-On Cut-End Cotton Mops	113
8-Ply Cut-End Cotton Mops	113

SPECIALTY AND FINISH WET MOPS

Synthetic Blend Mops	113
Clean Room Maintenance Mops	114
Rough-Floor Wet Mops	114
Nylon Finish Mops	114

WET MOP HANDLES

Wet Mop Handles	115
Adjustable Mop Handles	116
Laundry Net	116

MOPPING ACCESSORIES

BRUTE® Buckets	116
Pail and Mop Strainer Combination	117
Steel Sponge Mop/Double Pails	117
Dust Mop Selection Guide	119
Microfiber Looped-End Dust Mops	119
Twisted-Loop Dust Mops	120
Trapper® Dust Mops	121
Kut-A-Way® Dust Mops	121



FG758088YEL

Disposable Cut-End Blended Dust Mops.....	121
Disposable Cut-End Cotton Dust Mops.....	122
Snap-On Wire Dust Mop Frames.....	122
Snap-On Dust Mop Handles.....	122
Cut-to-Length Dust Mops.....	123
Wedge Mop System.....	123
MAXIMIZER™ Dust Mop with EZ Access Scraper.....	124
MAXIMIZER™ Overhead Cleaning Tool.....	124
DUST MOP FRAMES AND HANDLES	
Overhead Dusting Tools.....	125
Flexible-Head Overhead Dusting Tools.....	125
Lambswool Duster.....	125
CARPET BONNETS	
Carpet Bonnets.....	125
BROOMS	
Broom Construction.....	126
Anti-Twist Threaded Push Brooms.....	127
Assembled Push Brooms.....	127
MAXIMIZER™ Push-to-Center Broom.....	128
Street Sweeps.....	128
Broom Handles.....	128
Angle Brooms.....	129
Corn Brooms.....	129
Lobby Pro® Upright Dust Pans.....	129
BRUSHES	
Brush Construction Guide.....	130
Plastic-Handle Utility Brushes.....	130

CLEANING BRUSHES	
Truck and Wash Brush and Floor/Deck Scrub.....	131
Wire Brushes.....	131
Scrub Brushes.....	131
Toilet Bowl Brushes and Holders.....	132
Wall Washer Kit.....	132
Counter Brushes/Whisk Broom/ Heavy-Duty Dust Pans.....	132
Floor Squeegees.....	133

CLEANING TOOLS	
Lobby Pro® Wet/Dry Spill Pan.....	133
MAXIMIZER™ Wet/Dry Debris Pan.....	134
MAXIMIZER™ Broomgee™.....	134
MAXIMIZER™ Heavy Duty Debris Pan.....	134
MAXIMIZER™ 3-in-1 Floor Prep Tool.....	134
MAXIMIZER™ Quick Change Cleaning Tools.....	135

CLEANING CARTS	
High-Capacity Janitorial Cleaning Cart with Bins.....	138
High-Security Janitorial Cleaning Carts.....	138
High-Capacity Janitorial Cleaning Carts.....	139
Traditional Janitorial Cleaning Carts.....	139

CLEANING CART ACCESSORIES	
Cleaning, Deluxe Paneled, and Compact Housekeeping Cart Accessories.....	140

TRADITIONAL HOUSEKEEPING CARTS	
Executive Traditional Housekeeping Carts.....	142
Housekeeping Cart Bumper Kits.....	143
Housekeeping Cart Accessories.....	144

QUICK CARTS	
Executive Quick Carts.....	145
Executive Quick Cart – Large.....	146
Executive Quick Cart – Medium.....	146
Executive Quick Cart – Small.....	146

MECHANICAL SWEEPERS	
Mechanical Sweeper Selection Guide.....	147
Executive Single-Action Basic Mechanical Sweeper.....	147
Executive Dual-Action Bristle Mechanical Sweeper.....	147
Executive Dual-Action Brushless Mechanical Sweeper.....	147

TOOLS AND ACCESSORIES	
Closet Organizer and Tool Holder.....	148
Ironing Organizers.....	148
Mobile Two-Step Stepstool.....	148
Executive Spray Bottle, 32-Oz.....	149
Deluxe Carry Caddy.....	149

LOOK FOR THE SPECIALLY MARKED EXECUTIVE SERIES™ PRODUCTS.

CLEANING

HYGEN

WHY HYGEN™?

KILLING MICROBES DOESN'T MAKE THEM DISAPPEAR.

Traditional disposable products lack scrubbing power, streak and smear, and cannot remove microbes, leaving behind a food source for live pathogens. HYGEN™ Disposable Microfiber eliminates the food source and combines superior microfiber with built-in scrubber technology, in a disposable application, to prevent cross-transmission and reduce the risk of healthcare-associated infections.

Built-In Scrubbers

Innovative microbe-removing technology is complemented with built-in zigzag scrubbers to effectively remove dirt without streaking or smearing.

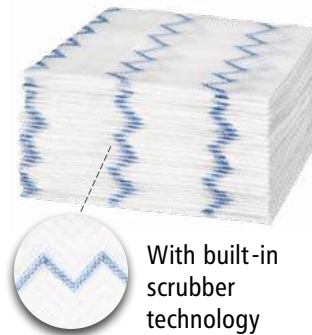

With built-in scrubber technology

REMOVES
99.9%
OF MICROORGANISMS,
INCLUDING C. DIFF.*
**STOP THE CHAIN
OF INFECTION.**

Microbe removal is a critical step in preventing infection. Removing dead microbes eliminates the food source for live pathogens.

RECOMMENDED HEALTHCARE APPLICATIONS

Occupied Patient Room	HYGEN™ Disposable Microfiber Cloths
Discharged Patient Room	HYGEN™ Disposable Microfiber Cloths and Mop
OR Terminal	HYGEN™ Disposable Microfiber Cloths
ER	HYGEN™ Disposable Microfiber Cloths and Mop
ICU / Isolation Room	HYGEN™ Disposable Microfiber Cloths and Mop
Nurses' Station	HYGEN™ Disposable Microfiber Cloths
MRI / X-ray Station	HYGEN™ Disposable Microfiber Cloths and Mop

*Based on third-party testing with water only. The product can be used with a wide array of cleaning solutions. EPA EST. 90650-NC-001

DISPOSABLE MICROFIBER SYSTEM

The HYGEN™ Disposable Microfiber System is the solution for optimizing infection prevention, ensuring environmental hygiene and improving productivity.

99.9% Microbe Removal, Including C. diff*

- Proven 99.9% microbe removal claim
- Helps stop the chain of infection
- Eliminates food source for live pathogens

Superior Cleaning Performance

- Microfiber cleaning with built-in scrubbing power
- Streak-free cleaning for mirrors, glass, and stainless steel
- Effectively removes dirt without smearing

Versatile Cleaning

- Compatible with bleach and quat
- Ideal for dusting and wet cleaning
- Convenient charging system and compatible with existing tools



NO.	DESCRIPTION	SIZE	COLOR	CASE PACK SIZE	QUANTITY PER CASE
1928756	HYGEN™ Disposable Microfiber Cloth Starter Kit	8" x 10"	WH00	1	160 Cloths + Tub
1928023	HYGEN™ Disposable Microfiber Cloth Refill Pack	8" x 10"	WH00	1	640 Cloths
1928024	HYGEN™ Disposable Microfiber Cloth Bulk Pack	8" x 10"	WH00	1	960 Cloths
1822351	HYGEN™ Disposable Microfiber Cloth Charging Tub	7.3" x 7.75"	WH00	1	4 Tubs
1822352	HYGEN™ Disposable Microfiber Mop Pad	18" x 5.5"	WH00	1	150 Mops

*Based on third-party testing with water only. The product can be used with a wide array of cleaning solutions. EPA EST. 90650-NC-001



HEALTHCARE

- Isolation room
- Discharged patient room
- Emergency room
- Intensive care unit



OFFICE BUILDINGS

- Lobby/reception area
- Conference room
- Break area
- Public restroom



SCHOOLS

- Classroom
- Administrative office
- Public restroom



RETAIL

- Retail fashion outlet
- Beauty salon



FOODSERVICE

- Front of house



HOSPITALITY

- Spa
- Health club
- Fitness studio

HYGEN™ Microfiber Cloths

HYGEN™ cloths with built-in scrubbers deliver debris removal when dust cleaning, and better liquid absorption for damp cleaning. When used with the 8-sided fold method, HYGEN™ cloths effectively clean more surface area. Double-finished edges and high-quality stitching retain shape and provide added durability.

- HYGEN™ cloths remove 99.9% of microbes including C. diff, with water alone
- HYGEN™ cloths are color-coded to assist in cleaning by area or task and help reduce cross-transmission
- Patented zig-zag scrubbers make cleanup quick and easy



REDUCE CROSS-TRANSMISSION

HYGEN™ Microfiber Cloths are color-coded to assist in cleaning by area or task and help reduce cross-transmission.



EXECUTIVE SERIES™ MICROFIBER CLOTHS

Glass/mirror cloths for scratch-free cleaning.



EXECUTIVE SERIES™

1867398

**PROVEN TO REMOVE
99.9%
OF MICROBES**



MICROFIBER CLOTHS

Yellow, red, green, and blue cloths for cleaning by area or task.

BLEACH-SAFE
in hot & cold water

Certified to tolerate CDC hot and cold water laundering requirements*

DURABLE UP TO 500

laundings**
(up to 200 with bleach)

NO.	COLOR	DESCRIPTION	U.S. DIMENSIONS	U.S. SHIP WT/CTN	METRIC DIMENSIONS	METRIC SHIP WT/CTN	PACK
FGQ61000	YL00	HYGEN™ Microfiber Bathroom Cloth (Yellow)	16" l x 16" w	0.6 lb	40.6 cm x 40.6 cm	0.3 kg	12
FGQ62000	GR00, RD00, BL00	HYGEN™ Microfiber General-Purpose Cloth (Green, Red, or Blue)	16" l x 16" w	0.65 lb	40.6 cm x 40.6 cm	0.29 kg	12
FGQ62006	GR00	HYGEN™ Microfiber General-Purpose Cloth (Green)	16" l x 16" w	0.8 lb	40.6 cm x 40.6 cm	0.4 kg	6
FGQ63000	BL00	HYGEN™ Microfiber Glass/Mirror Cloth (Blue)	16" l x 16" w	1.8 lb	40.6 cm x 40.6 cm	0.8 kg	12
Ⓢ 1867398	GRAY	Executive 16" HYGEN™ Glass Microfiber Cloth (Gray)	16" l x 16" w	1.8 lb	40.6 cm x 40.6 cm	0.8 kg	12
FGQ63006	BL00	HYGEN™ Microfiber Glass/Mirror Cloth (Blue)	16" l x 16" w	0.5 lb	40.6 cm x 40.6 cm	0.2 kg	6
FGQ64000	GR00	HYGEN™ Microfiber XL General-Purpose Cloth (Green)	20" l x 20" w	1.4 lb	50.8 cm x 50.8 cm	0.6 kg	12

* Always use cleaning chemicals or disinfectants as directed by your facility manager

** Based on internal testing without bleach

UTILITY REFUSE AND RECYCLING

DECORATIVE REFUSE

CLEANING

MATERIAL HANDLING

WASHROOM

FOODSERVICE

ACCESSORIES & INDEX



HYGEN™ Flexi-Frame

Clean faster and more effectively.

- Frame conforms to curved surfaces for better pickup of dirt and debris
- Frame flexes to clean both contoured and flat surfaces
- The proprietary material withstands harsh chemicals, including bleach and peroxide



EXECUTIVE SERIES™
1867396

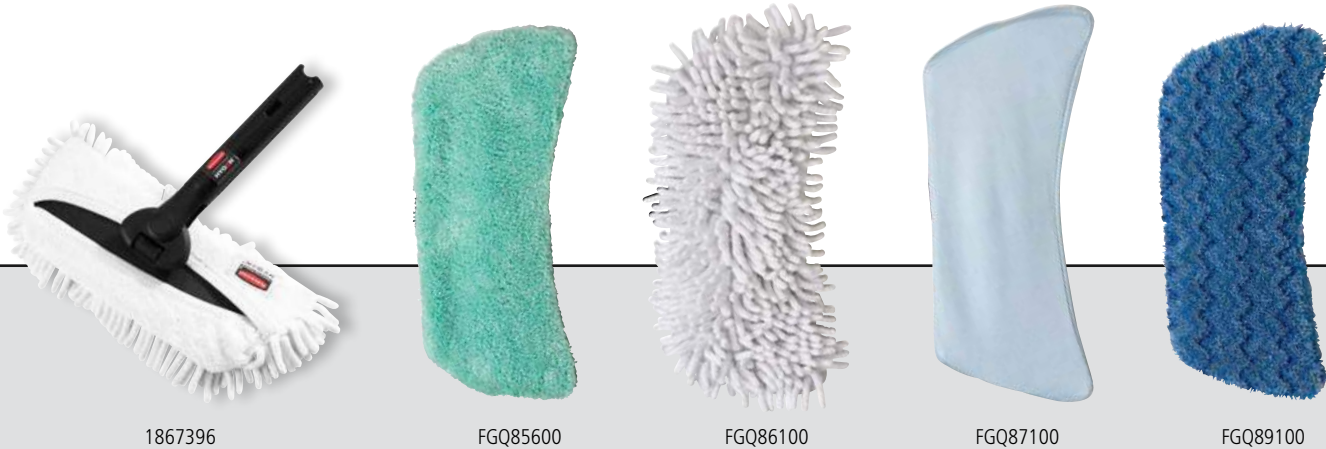

1867396

FGQ85600

FGQ86100

FGQ87100

FGQ89100

NO.	COLOR	DESCRIPTION	U.S. DIMENSIONS	U.S. SHIP WT/CTN	METRIC DIMENSIONS	METRIC SHIP WT/CTN	PACK
FGQ85500	BK00	11" HYGEN™ Microfiber Flexi-Frame	13.1" l x 5.4" w x 0.8" h	4.9 lb	33.3 cm x 13.7 cm x 2 cm	2.2 kg	6
1867396	BLACK	Executive 11" HYGEN™ Microfiber Flexible Flat Mop Frame, Single-Sided	13.1" l x 5.4" w x 0.8" h	4.9 lb	33.3 cm x 13.7 cm x 2 cm	2.2 kg	6
FGQ85600	GR00	HYGEN™ Microfiber Flexi-Frame Duster Cover	8.9" l x 5.9" w x 0.3" h	1.4 lb	22.6 cm x 15 cm x 0.8 cm	0.6 kg	12
FGQ86100	WH00	11" HYGEN™ Microfiber Flexi-Frame Hi-Pile Cover	8.9" l x 5.9" w x 0.9" h	2.2 lb	22.6 cm x 15 cm x 2.3 cm	1.0 kg	12
FGQ87100	BL00	HYGEN™ Microfiber Flexi-Frame Glass Cover	8.9" l x 5.9" w x 0.9" h	1.1 lb	22.6 cm x 15 cm x 2.3 cm	0.5 kg	12
FGQ88100	YL00	HYGEN™ Microfiber Flexi-Frame Tub and Tile Cover	8.3" l x 8.3" w x 0.3" h	1.6 lb	21.1 cm x 21.1 cm x 0.8 cm	0.7 kg	12
FGQ89100	BL00	HYGEN™ Microfiber Flexi-Frame Damp Mop Cover	8.3" l x 8.3" w x 0.3" h	1.8 lb	21.1 cm x 21.1 cm x 0.8 cm	0.8 kg	12

UTILITY REFUSE AND RECYCLING

DECORATIVE REFUSE

CLEANING

MATERIAL HANDLING

WASHROOM

FOODSERVICE

ACCESSORIES & INDEX



HYGEN™ Single-Sided Mops

Microfiber Dust Mops

Dust removal is critical to preventing the spread of infection.

- Split-blended HYGEN™ dust mops trap and lock away dust, dirt, and debris
- Dust mopping prior to damp mopping reduces floor hazing and best maintains floor finish
- Fringed dust mops improve debris pickup
- Industry leading hook and loop backing won't degrade during commercial laundering



50% more surface area
HYGEN™ fringed dust mops provide significantly greater surface area versus nonfringed mops for faster cleaning. Available in widths up to 60".



FGQ41200



FGQ41800



EXECUTIVE SERIES™
1867397

BLEACH-
SAFE
in hot & cold water

Certified to tolerate CDC hot and cold water laundering requirements.*

DURABLE UP TO

500

laundering**
(up to 200 with bleach)

Microfiber Dust Mops

NO.	COLOR	DESCRIPTION	U.S. DIMENSIONS	U.S. SHIP WT/CTN	METRIC DIMENSIONS	METRIC SHIP WT/CTN	PACK
FGQ41200	GR00, WH00	18" (45.7 cm) HYGEN™ Microfiber Room Dust Mop	21.0" l x 5.2" w x 0.5" h	1.4 lb	53.3 cm x 13.2 cm x 1.3 cm	0.6 kg	12
FGQ42400	GR00	24" (61 cm) HYGEN™ Microfiber Hall Dust Mop	27.5" l x 5.2" w x 0.5" h	2.5 lb	69.9 cm x 13.2 cm x 1.3 cm	1.1 kg	12
FGQ43600	GR00	36" (91.4 cm) HYGEN™ Microfiber Hall Dust Mop	39.5" l x 5.2" w x 0.5" h	3.3 lb	100.3 cm x 13.2 cm x 1.3 cm	1.5 kg	12
FGQ44800	GR00	48" (121.9 cm) HYGEN™ Microfiber Hall Dust Mop	51.5" l x 5.2" w x 0.5" h	5.5 lb	130.8 cm x 13.2 cm x 1.3 cm	2.5 kg	12

Microfiber Fringed Dust Mops

NO.	COLOR	DESCRIPTION	U.S. DIMENSIONS	U.S. SHIP WT/CTN	METRIC DIMENSIONS	METRIC SHIP WT/CTN	PACK
FGQ41800	GR00	18" (45.7 cm) HYGEN™ Microfiber Fringed Dust Mop	21.0" l x 9.0" w x 0.5" h	3.2 lb	53.3 cm x 22.9 cm x 1.3 cm	1.5 kg	6
1867397	GRAY	Executive HYGEN™ Multipurpose Microfiber PULSE™ Dust Flat Mop, Single-Sided	21.0" l x 9.0" w x 0.5" h	3.2 lb	53.3 cm x 22.9 cm x 1.3 cm	1.5 kg	6
FGQ42600	GR00	24" (61 cm) HYGEN™ Microfiber Fringed Dust Mop	27.5" l x 9.0" w x 0.5" h	3.5 lb	69.9 cm x 22.9 cm x 1.3 cm	1.6 kg	6
FGQ43800	GR00	36" (91.4 cm) HYGEN™ Microfiber Fringed Dust Mop	40.0" l x 9.0" w x 0.5" h	5.0 lb	101.6 cm x 22.9 cm x 1.3 cm	2.3 kg	6
FGQ44900	GR00	48" (121.9 cm) HYGEN™ Microfiber Fringed Dust Mop	52.0" l x 9.0" w x 0.5" h	6.8 lb	132.1 cm x 22.9 cm x 1.3 cm	3.1 kg	6
FGQ46000	GR00	60" (152.4 cm) HYGEN™ Microfiber Fringed Dust Mop	66.5" l x 9.0" w x 0.5" h	8.5 lb	168.9 cm x 22.9 cm x 1.3 cm	3.9 kg	6

* Always use cleaning chemicals or disinfectants as directed by your facility manager

** Based on internal testing without bleach

UTILITY REFUSE AND RECYCLING

DECORATIVE REFUSE

CLEANING

MATERIAL HANDLING

WASHROOM

FOODSERVICE

ACCESSORIES & INDEX



Microfiber Damp Mops

Premium split-blended HYGEN™ damp mops deliver optimal mopping performance.

- Patented scrubber strips effectively remove dirt without streaking or smearing
- Colored edge tape allows for task-specific cleaning and reduces the risk of cross-transmission
- Industry leading hook and loop backing won't degrade during commercial launderings

PROVEN TO REMOVE
99.9%
OF MICROBES

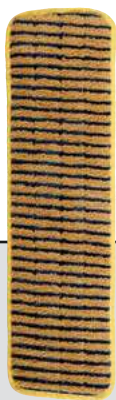

FGQ81000



FGQ41000



1863895

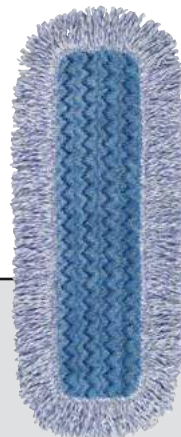

FGQ41600

BLEACH-
SAFE
in hot & cold water

Certified to tolerate CDC hot and cold water laundering requirements.*

DURABLE UP TO
500

laundings**
(up to 200 with bleach)

NO.	COLOR	DESCRIPTION	U.S. DIMENSIONS	U.S. SHIP WT/CTN	METRIC DIMENSIONS	METRIC SHIP WT/CTN	PACK
FGQ82000	BL00	11" (27.9 cm) HYGEN™ Microfiber Wall/Stair Damp Mop	13.0" l x 5.2" w x 0.5" h	1.5 lb	33.0 cm x 13.2 cm x 1.3 cm	0.7 kg	6
FGQ81000	YL00	18" (45.7 cm) HYGEN™ Microfiber Super Scrubber Mop	20.5" l x 5.2" w x 0.5" h	2.0 lb	52.1 cm x 13.2 cm x 1.3 cm	0.9 kg	6
FGQ41000	GR00, RD00, BL00	18" (45.7 cm) HYGEN™ Microfiber Damp Room Mop	20.5" l x 5.2" w x 0.5" h	2.9 lb	52.1 cm x 13.2 cm x 1.3 cm	1.3 kg	12
1863895	GRAY	Executive Series™ HYGEN™ 18" Microfiber Wet Pad	20.5" l x 5.2" w x 0.5" h	2.9 lb	52.1 cm x 13.2 cm x 1.3 cm	1.3 kg	12
FGQ41500	BL00	18" (45.7 cm) HYGEN™ Microfiber Damp Mop with Scrubber	20.5" l x 5.2" w x 0.5" h	2.8 lb	52.1 cm x 13.2 cm x 1.3 cm	1.3 kg	6
FGQ41600	BL00	18" (45.7 cm) HYGEN™ Microfiber High-Absorbency Mop	20.5" l x 5.2" w x 0.5" h	4.0 lb	52.1 cm x 13.2 cm x 1.3 cm	1.8 kg	6
FGQ41100	BL00	24" (61 cm) HYGEN™ Microfiber Damp Room Mop	26.0" l x 5.2" w x 0.5" h	4.1 lb	66.0 cm x 13.2 cm x 1.3 cm	1.9 kg	12
FGQ42500	BL00	24" (61 cm) HYGEN™ Microfiber Damp Mop with Scrubber	26.8" l x 5.2" w x 0.5" h	3.1 lb	68.1 cm x 13.2 cm x 1.3 cm	1.4 kg	6
1822352	WHITE	HYGEN™ Disposable 18" Microfiber Mop, Pkg. of 150	18.5" l x 5.2" w x 0.5" h	6.0 lb	47.0 cm x 13.2 cm x 1.3 cm	2.7 kg	1



HYGEN™ Quick-Connect Single-Sided Frames

Quick-Connect Frames feature a flat profile that slides easily under furniture and equipment. Trapezoidal shape improves cleaning in corners and other hard-to-reach areas.

- Lightweight aluminum construction is safe for MRI rooms
- Replaceable hook-and-loop strips attach all HYGEN™ Microfiber Damp and Dust Mops
- Rounded plastic end caps help protect walls and furniture



FGQ56000



EXECUTIVE SERIES™
1863893

FGQ57000 24" QUICK-CONNECT FRAME WITH SQUEEGEE

Features a unique pull-type squeegee for water and debris collection.



FGQ57000



FGQ56000

NO.	COLOR	DESCRIPTION	U.S. DIMENSIONS	U.S. SHIP WT/CTN	METRIC DIMENSIONS	METRIC SHIP WT/CTN	PACK
FGQ55000	YL00	11" (27.9 cm) HYGEN™ Quick-Connect Wet/Dry Frame	11" l x 3.0" w x 1.5" h	4.9 lb	27.9 cm x 7.6 cm x 3.8 cm	2.2 kg	6
FGQ56000	YL00	17" (43.2 cm) (45.7 cm) HYGEN™ Quick-Connect Wet/Dry Frame	17" l x 3.0" w x 1.5" h	6.5 lb	43.2 cm x 7.6 cm x 3.8 cm	2.9 kg	6
1863893	BLACK	Executive 17" (43.2 cm) HYGEN™ Quick-Connect Wet/Dry Frame	17" l x 3.0" w x 1.5" h	6.5 lb	43.2 cm x 7.6 cm x 3.8 cm	2.9 kg	6
FGQ57000	YL00	24" (61 cm) HYGEN™ Quick-Connect Wet/Dry Frame With Squeegee	24" l x 3.0" w x 1.5" h	9.2 lb	61.0 cm x 7.6 cm x 3.8 cm	4.2 kg	6
FGQ58000	YL00	35" (88.9 cm) HYGEN™ Quick-Connect Hall Dusting Frame	35" l x 3.0" w x 1.5" h	13.1 lb	88.9 cm x 7.6 cm x 3.8 cm	5.9 kg	6
FGQ59000	YL00	47" (119.4 cm) HYGEN™ Quick-Connect Hall Dusting Frame	47" l x 3.0" w x 1.5" h	16.7 lb	119.4 cm x 7.6 cm x 3.8 cm	7.6 kg	6
FGQ59500	YL00	59" (149.9 cm) HYGEN™ Quick-Connect Hall Dusting Frame	59" l x 3.0" w x 1.5" h	20.8 lb	149.9 cm x 7.6 cm x 3.8 cm	9.4 kg	6

Quick-Connect Frame Accessories

NO.	COLOR	DESCRIPTION	U.S. DIMENSIONS	U.S. SHIP WT/CTN	METRIC DIMENSIONS	METRIC SHIP WT/CTN	PACK
FGQ11000	BK00	11" (27.9 cm) HYGEN™ Hook-and-Loop Replacement Set for FGQ55000	8.7", 10.0" l x 1.1" w x 0.25" h	0.86 lb	22.1, 25.4 cm x 2.8 cm x 0.6 cm	0.39 kg	6
FGQ18000	BK00	17" (43.2 cm) HYGEN™ Hook-and-Loop Replacement Set for FGQ56000	14.7", 16.0" l x 1.1" w x 0.25" h	1.0 lb	37.3, 40.6 cm x 2.8 cm x 0.6 cm	0.04 kg	6
FGQ24000	BK00	24" (61 cm) HYGEN™ Hook-and-Loop Replacement Set for FGQ57000	21.3", 22.6" l x 1.1" w x 0.25" h	1.28 lb	54.1, 57.4 cm x 2.8 cm x 0.6 cm	0.58 kg	6
FGQ36000	BK00	35" (88.9 cm) HYGEN™ Hook-and-Loop Replacement Set for FGQ58000	32.6", 33.9" l x 1.1" w x 0.25" h	1.64 lb	82.8, 86.1 cm x 2.8 cm x 0.6 cm	0.74 kg	6
FGQ48000	BK00	47" (119.4 cm) HYGEN™ Hook-and-Loop Replacement Set for FGQ59000	44.6", 45.9" l x 1.1" w x 0.25" h	2.06 lb	113.3, 116.6 cm x 2.8 cm x 0.6 cm	0.93 kg	6
FGQ60000	BK00	59" (149.9 cm) HYGEN™ Hook-and-Loop Replacement Set for FGQ59500	56.7", 58.0" l x 1.1" w x 0.25" h	2.48 lb	144.0, 147.3 cm x 2.8 cm x 0.6 cm	1.1 kg	6

HYGEN™ Quick-Connect Equipment

Quick-Connect handles and poles make cleaning more efficient in every area of the facility. The unique connection mechanism allows for easy, time-saving tool exchange.

- Lightweight aluminum construction is safe for MRI rooms
- Handles available in straight or ergonomic bend styles, in adjustable lengths between 20" and 72"
- Extension poles make quick work of high-reach cleaning tasks, with lengths up to 18'
- FGQ70100 Quick-Connect Adapter allows use of Quick-Connect handles and poles with any standard threaded tool

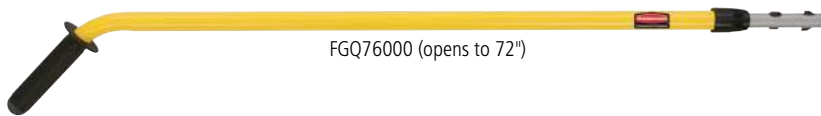

Quick-Connect Handles and Extension Poles

NO.	COLOR	DESCRIPTION	U.S. DIMENSIONS	U.S. SHIP WT/CTN	METRIC DIMENSIONS	METRIC SHIP WT/CTN	PACK
FGQ74500	YL00	20"-40" (50.8 cm-101.6 cm) HYGEN™ Quick-Connect Short Extension Handle	Open: 40" l x 2" w x 2" h Closed: 20" l x 2" w x 2" h	6.5 lb	Open: 101.6 cm x 5.1 cm x 5.1 cm Closed: 50.8 cm x 5.1 cm x 5.1 cm	2.9 kg	6
1863883	SILVER	Executive 20" to 40" (50.8 cm-101.6 cm) HYGEN™ Microfiber Telescoping Handle	Open: 40" l x 2" w x 2" h Closed: 20" l x 2" w x 2" h	6.5 lb	Open: 101.6 cm x 5.1 cm x 5.1 cm Closed: 50.8 cm x 5.1 cm x 5.1 cm	2.9 kg	6
FGQ75000	YL00	58" (147.3 cm) HYGEN™ Quick-Connect Handle	58" l x 1.6" w x 1.6" h	6.3 lb	147.3 cm x 4.1 cm x 4.1 cm	2.9 kg	6
FGQ75500	YL00	48"-72" (121.9 cm-182.9 cm) HYGEN™ Quick-Connect Straight Extension Handle	Open: 72" l x 2" w x 2" h Closed: 41" l x 2" w x 2" h	8.8 lb	Open: 182.9 cm x 5.1 cm x 5.1 cm Closed: 104.1 cm x 5.1 cm x 5.1 cm	4 kg	6
1863882	SILVER	Executive 42" to 72" (121.9 cm-182.9 cm) HYGEN™ Microfiber Telescoping Handle	Open: 72" l x 2" w x 2" h Closed: 41" l x 2" w x 2" h	8.8 lb	Open: 182.9 cm x 5.1 cm x 5.1 cm Closed: 104.1 cm x 5.1 cm x 5.1 cm	4 kg	6
FGQ76000	0000	48"-72" (121.9 cm-182.9 cm) HYGEN™ Quick-Connect Ergo Adjustable Handle	Open: 72" l x 7.5" w x 2.5" h Closed: 48" l x 7.5" w x 2.5" h	8.7 lb	Open: 182.9 cm x 19.1 cm x 6.4 cm Closed: 121.9 cm x 19.1 cm x 6.4 cm	3.9 kg	6
FGQ76500	YL00	4'-8' HYGEN™ Quick-Connect Extension Pole	Open: 96" l x 2.1" w x 2.1" h Closed: 48" l x 2.1" w x 2.1" h	16.7 lb	Open: 243.8 cm x 5.3 cm x 5.3 cm Closed: 121.9 cm x 5.3 cm x 5.3 cm	7.6 kg	6
FGQ77000	YL00	6'-12' HYGEN™ Quick-Connect Extension Pole	Open: 144" l x 2.1" w x 2.1" h Closed: 72" l x 2.1" w x 2.1" h	21.7 lb	Open: 365.8 cm x 5.3 cm x 5.3 cm Closed: 182.9 cm x 5.3 cm x 5.3 cm	9.8 kg	6
FGQ77500	YL00	6'-18' HYGEN™ Quick-Connect Extension Pole	Open: 216" l x 2.1" w x 2.1" h Closed: 72" l x 2.1" w x 2.1" h	16.6 lb	Open: 548.6 cm x 5.3 cm x 5.3 cm Closed: 182.9 cm x 5.3 cm x 5.3 cm	7.5 kg	3
FGQ70100	BK00	ACME to HYGEN™ Quick-Connect Adapter	4.5" l x 1.1" w x 1.1" h	0.3 lb	11.4 cm x 2.8 cm x 2.8 cm	0.14 kg	3



HYGEN™ Microfiber Buckets

HYGEN™ Microfiber Buckets complete a highly efficient flat mop cleaning system.

Charging Bucket

- Use with HYGEN™ Microfiber Damp Mops and Quick-Connect tools for a continuous cleaning process with “no touch” wringing
- Easy-to-clean, lightweight nonporous plastic construction
- Buckets work with all HYGEN™ Microfiber Cleaning Carts

Charging Bucket with Sieve

- Sieve design enables users to effectively and ergonomically moisten mops
- Holds double-sided microfiber mops

Press Wring Bucket

- Use when flood cleaning or heavier liquid lay-down is desired
- Press sieve provides easy, “no touch” wringing
- For use with single-sided microfiber flat mops up to 18" in length
- Nonmarking casters
- Floor drain for fast emptying
- Available in blue with lid (item FGQ93000) for floor finish application



FGQ95088

EXECUTIVE SERIES™
1863892

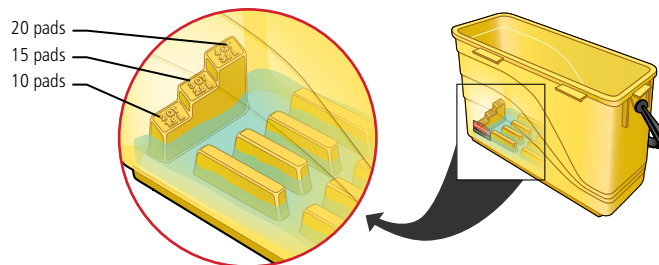

FGQ95088 Bucket design prevents oversaturation of microfiber mops and features a measuring guide for filling with cleaning and disinfecting solution before mops are added.

USING THE 1791802 CHARGING BUCKET

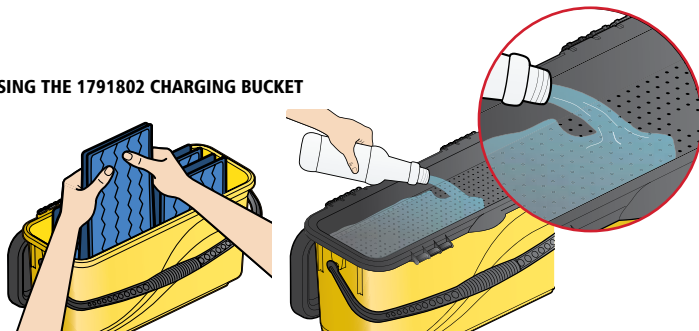

1. Fold the mop in half with the face material outside. Place folded mop vertically inside the bucket.
2. Pour disinfectant over the hinged sieve to moisten the mops evenly.



1791802



Unique, ribbed “washboard” surface removes dirt and debris from mops before wringing.



FGQ90088

NO.	COLOR	DESCRIPTION	U.S. DIMENSIONS	U.S. SHIP WT/CTN	METRIC DIMENSIONS	METRIC SHIP WT/CTN	PACK
FGQ95088	YEL	HYGEN™ Charging Bucket	23.88" l x 9.5" w x 13.63" h	16 lb	60.7 cm x 24.1 cm x 34.6 cm	7.3 kg	3
1863892	GRAY	Executive HYGEN™ Microfiber Charging Mop Bucket	23.88" l x 9.5" w x 13.63" h	16 lb	60.7 cm x 24.1 cm x 34.6 cm	7.3 kg	3
1791802	YELLOW	HYGEN™ Charging Bucket with Sieve	23.88" l x 9.5" w x 13.63" h	17 lb	60.7 cm x 24.1 cm x 34.6 cm	7.9 kg	3
FGQ90088	YEL	HYGEN™ Press Wring Bucket	14.5" l x 26.2" w x 16.1" h	10 lb	36.8 cm x 66.5 cm x 40.9 cm	4.6 kg	1

UTILITY REFUSE AND RECYCLING

DECORATIVE REFUSE

CLEANING

MATERIAL HANDLING

WASHROOM

FOODSERVICE

ACCESSORIES & INDEX

PULSE™ Microfiber Floor Cleaning System with Single-Sided Frame

PULSE™ Mop cleans more square feet in less time when used with HYGEN™ Microfiber Damp Mops for cleaner floors faster and easier.

- Patented onboard reservoir and solution system evenly dispense liquid behind the mop



FGQ96600
PULSE™ Caddy

LIGHTWEIGHT CONSTRUCTION
WEIGHS 6 LBS FULLY LOADED

1835528

ERGONOMIC TRIGGER HANDLE

EXECUTIVE SERIES™
1863884

ONBOARD RESERVOIR HOLDS ENOUGH
SOLUTION TO CLEAN 850 SQ FT

FLUID LEVEL WINDOWS

PULSE™ MOPPING KIT INCLUDES:

- One Trigger Handle with Fluid Reservoir
- One 17" HYGEN™ Quick-Connect Frame (FGQ56000YL00)
- Two 18" HYGEN™ Damp Mops (FGQ41000BL00)

NO.	COLOR	DESCRIPTION	U.S. DIMENSIONS	U.S. CAPACITY	U.S. SHIP WT/CTN	METRIC DIMENSIONS	METRIC CAPACITY	METRIC SHIP WT/CTN	PACK
1835528	YELLOW	HYGEN™ PULSE™ Mopping Kit with Single-Sided Frame	56" l x 4.88" w x 3.75" h	19 oz	5.7 lb	142.2 cm x 12.4 cm x 9.5 cm	.56 L	2.6 kg	1
1863884	SILVER	Executive HYGEN™ PULSE™ Microfiber Spray Mop, Single-Sided Flat Mop	56" l x 4.88" w x 3.75" h	19 oz	5.7 lb	142.2 cm x 12.4 cm x 9.5 cm	.56 L	2.6 kg	1
FGQ96600	0000	HYGEN™ PULSE™ Caddy	14.13" l x 8.75" w x 10.75" h	2 gal	3.6 lb	35.9 cm x 22.2 cm x 27.3 cm	7.5 L	1.6 kg	1

PULSE™ Microfiber Floor Cleaning System with Double-Sided Frame

The PULSE™ Double-Sided Mopping Kit combines dust and wet mopping with no downtime switching tools. Simply flip the mop over to transition from dry cleaning to wet mopping. The onboard reservoir eliminates the need for filling and emptying buckets.

Or, use with double-sided microfiber damp mops to double the number of square feet cleaned without replacing the mop.

1835529 PULSE™ Floor Cleaning Kit with Double-Sided Frame

Includes:
Trigger Handle with Fluid Reservoir,
one Double-Sided Folding Frame, and
two microfiber dust and wet mops.

ONBOARD FLUID RESERVOIR
High-capacity refillable reservoir holds enough solution to clean up to 850 sq ft of floor space. Reservoir windows allow easy monitoring of fluid level.

TRIGGER HANDLE
Red ergonomic trigger handle dispenses three streams of cleaning solution with each press.

LIGHTWEIGHT CONSTRUCTION
Weighs only 4 lbs when fully loaded with solution.

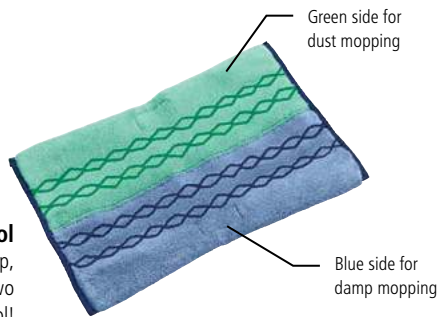

2 Jobs, 1 Tool
Simply dust mop, flip, and damp mop—accomplish two tasks with only one tool!

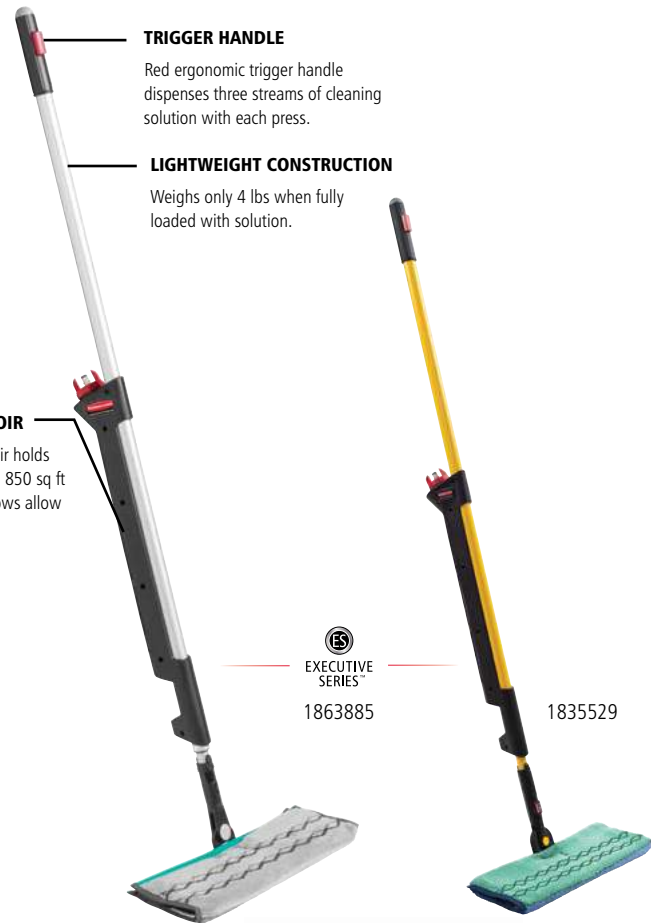

BLEACH-SAFE
in hot & cold water

Certified to tolerate CDC hot and cold water laundering requirements*

DURABLE UP TO 500
laundryings**
(up to 200 with bleach)



Double-Sided Microfiber Mops
Specifically designed for the HYGEN™ Clean Water System, HYGEN™ Charging Bucket with Sieve, and Double-Sided PULSE™ Mopping Kit, the double-sided mop design provides twice the coverage and consistent, streak-free cleaning.

- HYGEN™ double-sided mops feature different textiles on each side to target specific floor types
- Color-coded ribbons allow for task-specific cleaning and reduce cross-transmission



COLOR-CODED RIBBONS
Classify mop usage to help prevent cross-contamination.

NO.	COLOR	DESCRIPTION	U.S. DIMENSIONS	U.S. SHIP WT/CTN	METRIC DIMENSIONS	METRIC SHIP WT/CTN	PACK
1791678	GRAY	HYGEN™ General-Purpose Microfiber Mop	17.5" l x 12" w x 0.5" h	3.1 lb	44.5 cm x 30.5 cm x 1.3 cm	1.4 kg	6
1791796	BLUE	HYGEN™ Rough-Surface Scrub Microfiber Mop	17.5" l x 12" w x 1" h	3.5 lb	44.5 cm x 30.5 cm x 2.5 cm	1.6 kg	6
1791680	BLUE	HYGEN™ Microfiber Mop Plus	17.5" l x 12" w x 0.5" h	2.6 lb	44.5 cm x 30.5 cm x 1.3 cm	1.2 kg	6
1791679***	GREEN/BLUE	HYGEN™ Microfiber Wet and Dust Mop Plus for PULSE™	17.5" l x 12" w x 0.5" h	2.7 lb	44.5 cm x 30.5 cm x 1.3 cm	1.2 kg	6

* Always use cleaning chemicals or disinfectants as directed by your facility manager

** Based on internal testing without bleach

*** To be used with PULSE™ with Double-Sided Frame

UTILITY REFUSE AND RECYCLING

DECORATIVE REFUSE

CLEANING

MATERIAL HANDLING

WASHROOM

FOODSERVICE

ACCESSORIES & INDEX

Double-Sided Frames

- Easy to attach and detach mop
- Stainless steel components for enhanced durability
- For use with Double-Sided Microfiber Mops

EXECUTIVE SERIES™
1863894



Double-Sided Frame
Provides twice the coverage.

EASY HANDS-FREE MOP ATTACHMENT



1. Place frame on open mop and slide it into pockets.





2. Lift . . .



. . . and fold the frame closed for double-sided mopping.

NO.	COLOR	DESCRIPTION	U.S. DIMENSIONS	U.S. CAPACITY	U.S. SHIP WT/ CTN	METRIC DIMENSIONS	METRIC CAPACITY	METRIC SHIP WT/ CTN	PACK
1835529	YELLOW	HYGEN™ PULSE™ Mopping Kit with Double-Sided Folding Frame	52" l x 4.25" w x 3.5" h	19 oz	4.5 lb	132.1 cm x 10.8 cm x 8.9 cm	.56 L	2.0 kg	1
1863885	SILVER	Executive HYGEN™ PULSE™ Microfiber Spray Mop, Double-Sided Flat Mop	52" l x 4.25" w x 3.5" h	19 oz	4.5 lb	132.1 cm x 10.8 cm x 8.9 cm	.56 L	2.0 kg	1
1863894*	BLACK	Executive 18" HYGEN™ PULSE™ Microfiber Flat Mop Frame, Double-Sided	16.25" l x 8.5" w x 0.938" h	N/A	6.25 lb	41.3 cm x 21.6 cm x 2.4 cm	N/A	2.8 kg	3
FGQ96600	0000	HYGEN™ PULSE™ Caddy	14.13" l x 8.75" w x 10.75" h	2 gal	3.6 lb	35.9 cm x 22.2 cm x 27.3 cm	7.5 L	1.6 kg	1

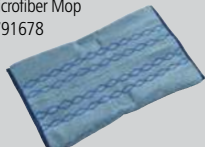
*To be used with PULSE™ with Double-Sided Frame.

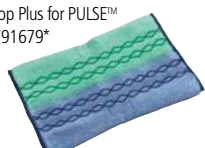
	Microbe Removal	Absorbency	Grease/Oil Removal	General Soil Removal	Durability	Floor Type	Environment
General-Purpose Microfiber Mop 1791678 						Smooth surfaces such as VCT, Linoleum, and Marble	Office Buildings, Schools, Retail Stores, Airports, and Stadiums
Rough-Surface Scrub Microfiber Mop 1791796 						Textured surfaces such as Ceramic Tile, Natural Stone, and Terrazzo	Restaurants, Schools
Microfiber Mop Plus 1791680 	 99.9%					Smooth surfaces such as VCT, Linoleum, and Marble	Healthcare
Microfiber Wet and Dust Mop Plus for PULSE™ 1791679* 	 99.9%					Smooth surfaces such as VCT, Linoleum, and Marble	Healthcare

HYGEN™ Microfiber Flexible Dusting Wands

Removes dust from crevices and hard-to-reach places.

- Wand bends to conform to irregular surfaces
- Use with HYGEN™ Quick-Connect handles to convert wand into an extended-reach cleaning tool



BLEACH-

SAFE

in hot & cold water

Certified to tolerate CDC hot and cold water laundering requirements*

FGQ85200



BETTER SURFACE CONTACT

Flexible duster frame conforms to the shape of the surface being cleaned. Excellent for cleaning hard-to-reach areas. Use hand-held or with HYGEN™ Quick-Connect handles and extension poles.

NO.	COLOR	DESCRIPTION	U.S. DIMENSIONS	U.S. SHIP WT/CTN	METRIC DIMENSIONS	METRIC SHIP WT/CTN	PACK
FGQ85000	BK00	HYGEN™ Quick-Connect Flexible Dusting Wand with Microfiber Sleeve	28.75" l x 3.25" w x 1.5" h	1.8 lb	73 cm x 8.3 cm x 3.8 cm	0.8 kg	6
FGQ85100	GR00	HYGEN™ Wand Duster Microfiber Replacement Sleeve	22.7" l x 3.25" w x 0.75" h	1.2 lb	57.7 cm x 8.3 cm x 1.9 cm	0.5 kg	6
⑤ FGQ85200	WH00	Executive 22" HYGEN™ Multipurpose Flexible Microfiber Duster and Frame	28.4" l x 1.13" w x 1.13" h	5.0 lb	72.1 cm x 2.9 cm x 2.9 cm	2.3 kg	6
⑤ FGQ85300	WH00	Executive 22" HYGEN™ Multipurpose Flexible Microfiber Duster	12.3" l x 7" w x 0.74" h	2.8 lb	31.2 cm x 17.8 cm x 1.9 cm	1.3 kg	6

* Always use cleaning chemicals or disinfectants as directed by your facility manager

HYGEN™ Microfiber Mitts

HYGEN™ mitts are double-sided to easily dust and damp clean crevices and irregular surfaces.

- Ideal for cleaning glass and chrome surfaces, general-purpose cleaning, and dry dusting
- Use in pairs for added efficiency



NO.	COLOR	DESCRIPTION	U.S. DIMENSIONS	U.S. SHIP WT/CTN	METRIC DIMENSIONS	METRIC SHIP WT/CTN	PACK
FGQ65000	GR00	HYGEN™ Microfiber All-Purpose Mitt with Thumb	11" l x 8.75" w	2.4 lb	27.9 cm x 22.2 cm	1.1 kg	12
FGQ65100	BL00	HYGEN™ Microfiber Glass/Mirror Mitt with Thumb	11" l x 8.75" w	2.2 lb	27.9 cm x 22.2 cm	1 kg	12
FGQ65200	GR00	HYGEN™ Microfiber Dusting Mitt with Thumb	11.9" l x 9.9" w	1.5 lb	30.2 cm x 25.1 cm	0.7 kg	6

When ordering products with **BOLD** color codes, please specify color code after the product number. Refer to the Standard Color Guide at the back of the catalog.

HYGEN™ Sanitizer-Safe Microfiber Cloths

The more durable and versatile solution for back-and front-of-house cleaning tasks.

- Proven to remove 95% of microbes
- Quat- and bleach-safe to help maintain sanitizer effectiveness
- Cleans effectively with less chemical replenishment
- Removes stains 30% more effectively than cotton cloths
- Launderable up to 40x

1824723



NO.	COLOR	DESCRIPTION	U.S. DIMENSIONS	U.S. SHIP WT/CTN	METRIC DIMENSIONS	METRIC SHIP WT/CTN	PACK
1805727	RD00	Sanitizer-Safe Microfiber Cloth – Red	19" l x 16" w x 0.06" h	23.04 lb	48.26 cm x 40.64 cm x 0.15 cm	10.45 kg	288
1805728	BL00	Sanitizer-Safe Microfiber Cloth – Blue	19" l x 16" w x 0.06" h	23.04 lb	48.26 cm x 40.64 cm x 0.15 cm	10.45 kg	288
1805730	GR00	Sanitizer-Safe Microfiber Cloth – Green	19" l x 16" w x 0.06" h	23.04 lb	48.26 cm x 40.64 cm x 0.15 cm	10.45 kg	288
1824723	RD/BL/YL/GR	Sanitizer-Safe Microfiber Cloth – 4-Pack	7.25" l x 1.75" w x 8.0" h	4.00 lb	18.42 cm x 4.45 cm x 20.32 cm	1.82 kg	4

HYGEN™ Microfiber Kit with Charging Bucket

The single-source solution with all microfiber products needed to clean up to 12 patient rooms.

- 7.25-cubic-foot storage capacity offers 40% more space than traditional carts so user spends less time retrieving supplies and more time completing the task at hand
- Secure cabinet doors keep cleaning supplies concealed from view and locked up when carts are unattended
- Quiet nonmarking 8" wheels and 4" casters provide smooth maneuverability
- Compact size fits great in space-constrained areas; with a high capacity-to-footprint ratio, only 22" wide
- Joint commission-compliant to meet Environment of Care Standard 3.10.3 with locking doors and hood

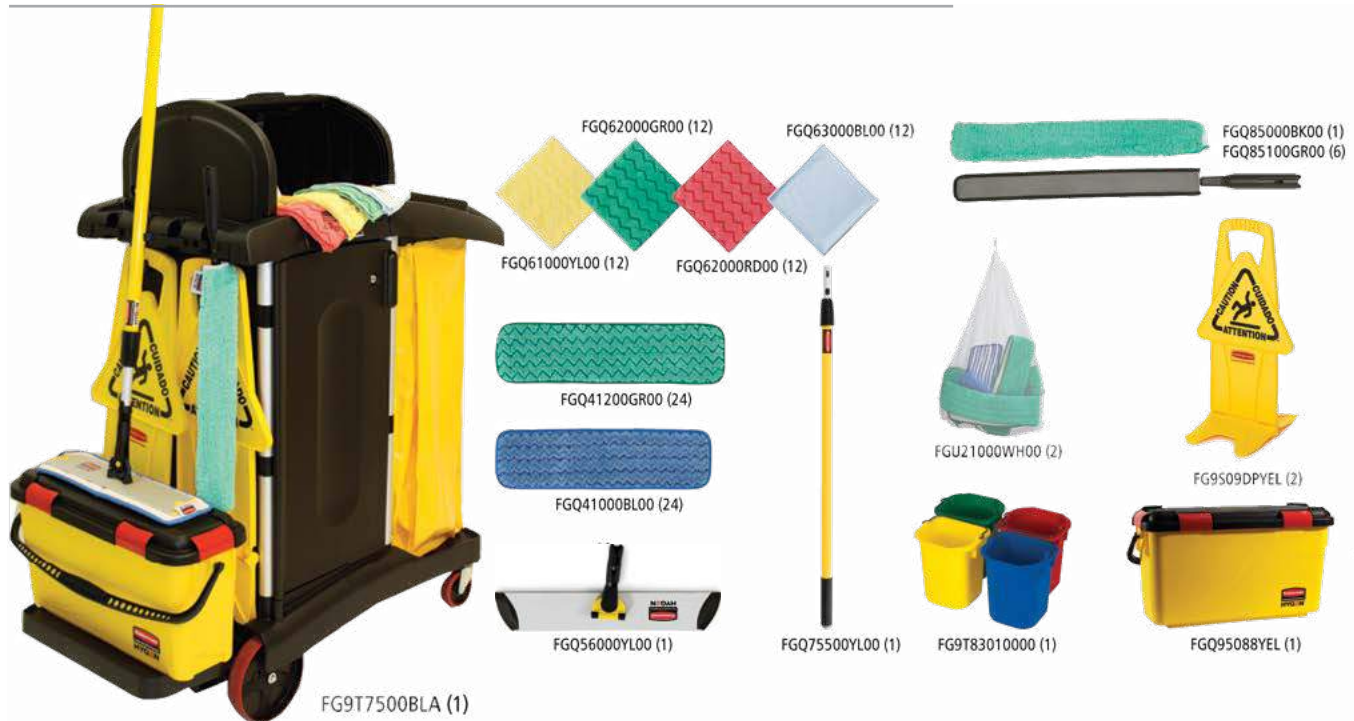

NO.	COLOR	DESCRIPTION	U.S. DIMENSIONS	U.S. SHIP WT/CTN	METRIC DIMENSIONS	METRIC SHIP WT/CTN	PACK
1784284	N/A	HYGEN™ Microfiber Kit with Charging Bucket	48" l x 29" w x 27" h	112.0 lb	121.9 cm x 73.7 cm x 68.6 cm	50.9 kg	1



Light Commercial Microfiber Cloths and Mops

Quality microfiber products for less-demanding users.

- Hook-and-loop backing attaches pads securely to frame
- Durable up to 200 commercial launderings and 100 with bleach
- Proven to remove 99.9% of microbes



EXECUTIVE SERIES™
1863888



FGQ40800



3486108



FGQ40900



FGQ55900



FGQ74900

NO.	COLOR	DESCRIPTION	U.S. DIMENSIONS	U.S. SHIP WT/CTN	METRIC DIMENSIONS	METRIC SHIP WT/CTN	PACK
FGQ40800	GR00	18" (45.7 cm) Light Commercial Microfiber Fringed Dust Mop	20" l x 8" w x 0.5" h	3.0 lb	50.8 cm x 20.3 cm x 1.3 cm	1.3 kg	12
FGQ40900	BL00	18" (45.7 cm) Light Commercial Microfiber Damp Mop	20" l x 5" w x 0.5" h	1.8 lb	50.8 cm x 12.7 cm x 1.3 cm	0.8 kg	12
FGQ55900	BK00	18" (45.7 cm) Light Commercial Quick-Connect Wet/Dry Plastic Frame	17.6" l x 3.0" w x 1.5" h	6.1 lb	44.7 cm x 7.6 cm x 3.8 cm	2.8 kg	6
1820577	PINK	12" x 12" Microfiber Light Commercial Cloth	12" l x 12" w	13.8 lb	30.5 cm x 30.5 cm	6.3 kg	288
1820578	GREEN	12" x 12" Microfiber Light Commercial Cloth	12" l x 12" w	13.8 lb	30.5 cm x 30.5 cm	6.3 kg	288
1820579	BLUE	12" x 12" Microfiber Light Commercial Cloth	12" l x 12" w	13.8 lb	30.5 cm x 30.5 cm	6.3 kg	288
1820580	YELLOW	12" x 12" Microfiber Light Commercial Cloth	12" l x 12" w	13.8 lb	30.5 cm x 30.5 cm	6.3 kg	288
1863888	GRAY	Executive 12" Multipurpose Microfiber Cloth	12" l x 12" w	13.8 lb	30.5 cm x 30.5 cm	6.3 kg	288
1820581	PINK	16" x 16" Microfiber Light Commercial Cloth	16" l x 16" w	13.8 lb	40.6 cm x 40.6 cm	6.3 kg	288
1820582	GREEN	16" x 16" Microfiber Light Commercial Cloth	16" l x 16" w	13.8 lb	40.6 cm x 40.6 cm	6.3 kg	288
1820583	BLUE	16" x 16" Microfiber Light Commercial Cloth	16" l x 16" w	13.8 lb	40.6 cm x 40.6 cm	6.3 kg	288
1820584	YELLOW	16" x 16" Microfiber Light Commercial Cloth	16" l x 16" w	13.8 lb	40.6 cm x 40.6 cm	6.3 kg	288
1863889	GRAY	Executive 16" Multipurpose Microfiber Towel	16" l x 16" w	13.8 lb	40.6 cm x 40.6 cm	6.3 kg	288
FGQ74900	YL00	52" (132 cm) Light Commercial Quick-Connect Steel Handle	52" l 1.0" w 1.0" h	7.1 lb	132.1 cm x 2.5 cm x 2.5 cm	3.2 kg	6
3486108	N/A	Light Commercial Microfiber Spray Mop (mop pad not included)	52" l x 4.5" w x 3.5" h	3.0 lb	132.1 cm x 11.4 cm x 8.9 cm	1.4 kg	1
3486110	N/A	15-oz Replacement Refill Cartridge for 3486108	3.25" l x 2.75" w x 8.75" h	2.4 lb	8.3 cm x 7.0 cm x 22.2 cm	1.1 kg	6

FLOW™ Finishing Systems

Help reduce labor costs and improve worker productivity and well-being with the highly portable FLOW™ Floor Finishing System. High-capacity backpack and handle system allows user-controlled release of solution for more efficient floor finishing.

FGQ97900 FLOW™ FLAT MOP FINISH KIT

INCLUDES:

Backpack, Trigger Handle, 17" Quick-Connect Frame, and FGQ80500 FLOW™ Nylon Flat Mop



TRIGGER HANDLE

Red ergonomic trigger handle dispenses finish solution with each press.

IMPROVED COMFORT

Backpack features venting channels to improve airflow and reduce moisture on back while wearing.

CLEAN CONNECT™ TECHNOLOGY:

Backpack hose connects to the trigger handle using Clean Connect™ technology for spill-free delivery of finish solution.

STRING MOP OR FLAT MOP OPTIONS

Kit includes an FGQ80500 FLOW™ Nylon Flat Mop. It connects easily to the handle using Quick-Connect.

PROTECTS WORKER WELL-BEING

Chest and waist straps distribute weight onto user's hips instead of shoulders, reducing user strain.



High-Capacity Backpack System

FLOW™ holds 1.5 gallons for finishing up to 3,000 sq ft of floor surface. The 3" diameter opening makes refilling easy.

NO.	COLOR	DESCRIPTION	U.S. DIMENSIONS	U.S. CAPACITY	U.S. SHIP WT/ CTN	METRIC DIMENSIONS	METRIC CAPACITY	METRIC SHIP WT/ CTN	PACK
FGQ97900	YL00	FLOW™ Flat Mop Finish Kit	56" l x 9.75" w x 3.75" h	1.5 gal	8.2 lb	142.2 cm x 24.8 cm x 9.5 cm	5.7 L	3.7 kg	1
FGQ80500	WH00	FLOW™ Nylon Flat Mop	6.5" l x 3.15" w x 19.7" h	N/A	5 lb	16.5 cm x 8 cm x 50 cm	N/A	2.3 kg	6
FGQ97700	0000	FLOW™ Replacement Bladder	20" l x 6" w x 0.4" h	1.5 gal	2.4 lb	50.8 cm x 15.2 cm x 1 cm	5.7 L	1.1 kg	2

UTILITY REFUSE AND RECYCLING

DECORATIVE REFUSE

CLEANING

MATERIAL HANDLING

WASHROOM

FOODSERVICE

ACCESSORIES & INDEX



UTILITY REFUSE
AND RECYCLING

DECORATIVE REFUSE

CLEANING

MATERIAL HANDLING

WASHROOM

FOODSERVICE

ACCESSORIES
& INDEX

Microfiber Flat Mop Finishing

Finish Bucket

Same features as the Microfiber Press Wring Bucket, in the blue color most often associated with finish applications.

Finish Pad

Produce beautiful, professional results easier and more quickly than traditional methods.

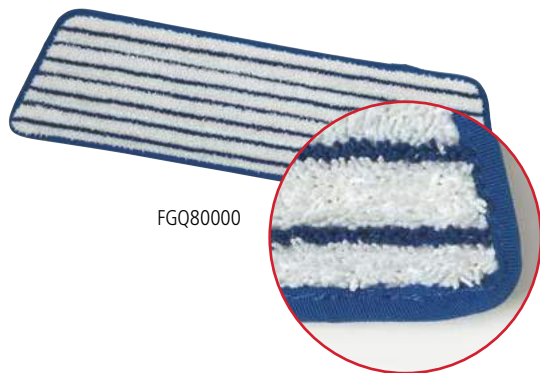

FGQ80000



FGQ93000

Microfiber Finish System

Helps ensure controlled absorption and release of finish.

- Delivers 200–300 square feet (18.6 m²–27.9 m²) of coverage with a single mop load of finish
- Split microfiber for the fastest and smoothest finish application
- Resealable Finish Bucket (FGQ93000) keeps finish fresh until the next job, saving cleanup time
- Smooth, nonporous bucket cleans easily, reducing time spent on stripping traditional mop bucket/wringer combinations



FGQ05000

Microfiber Flat Mop Pad

NO.	COLOR	DESCRIPTION	U.S. DIMENSIONS	U.S. SHIP WT/CTN	METRIC DIMENSIONS	METRIC SHIP WT/CTN	PACK
FGQ80000	WH00	18" (45.7 cm) Microfiber Finish Pad	18" l x 5.5" w x 0.5" h	1.9 lb	45.7 cm x 14 cm x 1.3 cm	0.9 kg	6
FGQ93000	BLUE	Finish Bucket	14.7" l x 26.2" w x 16.2" h	12.1 lb	37.3 cm x 66.5 cm x 41.1 cm	5.5 kg	1

Microfiber Finish System

NO.	COLOR	DESCRIPTION	U.S. DIMENSIONS	U.S. CAPACITY	U.S. SHIP WT/CTN	METRIC DIMENSIONS	METRIC CAPACITY	METRIC SHIP WT/CTN	PACK
FGQ05000	0000	Microfiber Finish System, Includes Bucket with Lid, Sieve, 8 Pads, 1 Frame	18" l x 5" w	22 qt	10.6 lb	45.7 cm x 12.7 cm	20.8 L	4.8 kg	1
FGE05200	WH00	Finish Mop, Looped Fringe	18" l x 5" w	N/A	5.0 lb	45.7 cm x 12.7 cm	N/A	2.3 kg	6



UTILITY REFUSE
AND RECYCLING

DECORATIVE REFUSE

CLEANING

MATERIAL HANDLING

WASHROOM

FOODSERVICE

ACCESSORIES
& INDEX

1835528, FGQ41600BL00, 1861427





WAVEBRAKE®

JUST GOT A

WHOLE LOT BETTER

Rubbermaid Commercial Products introduced the first resin mop bucket in 1974. The BRUTE® mop bucket was introduced in 1995 with new ergonomic features. WaveBrake® was introduced in 2005 with a patented bucket and baffle design that reduced splashing for more efficient, safer mopping.

Rubbermaid Commercial Products continues to innovate, improving the industry-leading splash reduction and adding new features that surpass any other traditional mop bucket. These new features help the New Generation WaveBrake® clean floors with less effort to get the job done safer.

Proudly made in Winchester, Virginia, WaveBrake® features structural web-molded plastic construction to ensure the highest quality and durability you have come to expect while delivering industry-leading performance.

THE NEW GENERATION WAVEBRAKE®



UTILITY REFUSE
AND RECYCLING

DECORATIVE REFUSE

CLEANING

MATERIAL HANDLING

WASHROOM

FOODSERVICE

ACCESSORIES
& INDEX



UP TO 80% LESS SPLASH¹

Patented WaveBrake® baffles result in less splashing while mopping and maneuvering, helping to create a safer environment for patrons and staff.



EASY TO EMPTY

A built-in drain eliminates the strain of lifting and bending when emptying mop buckets. Integrated handles help ensure a secure grip to lift and empty the mop bucket.



5-YEAR WRINGER GUARANTEE²

The side-press and down-press wringers are designed to last 5 years or 200,000 wringing cycles.

¹ Versus competitive 35Qt U.S. single compartment mop bucket and wringer, not including divider bucket and accessories. ² Based on internal side-press testing.







COLOR-CODED

CLEANING

Cleaning professionals today use a color-coded cleaning system, using color-coded buckets, handles and mops to help reduce cross-contamination. Additionally, they can be organized by function, department or building area, making it easier to track usage.

RECOMMENDED USAGE:

Color-coding systems can vary by vertical and application; however, Rubbermaid Commercial Products, in alignment with industry experts, recommends the following system:

-  **Yellow:** Back-of-House Cleaning
-  **Brown:** Back-of-House Cleaning
-  **Red:** High-Risk Restroom Areas
-  **Blue:** General-Purpose Cleaning
-  **Green:** General Food Processing, Serving and Bar Areas
-  **Black:** Front-of-House Cleaning



WaveBrake® Buckets and Wringers
 With features that surpass traditional mop buckets, the new generation of WaveBrake® helps to clean floors with less effort to get the job done safer, without sacrificing quality and durability.

- **IMPROVE SAFETY AND PRODUCTIVITY:** Patented WaveBrake® baffles result in less splashing while mopping and maneuvering, helping to create a safer environment for patrons and staff. Additionally, water stays in the bucket, eliminating unnecessary trips to the storage closet to fill up the bucket, enhancing productivity.
- **80% LESS SPLASHING:** Molded-in WaveBrake® baffles disrupt wave formation, reducing splash up to 80% versus leading competitors.* (*Versus competitive U.S. 35 qt single compartment mop bucket and wringer, not including divider bucket and accessories.)
- **CONVENIENT TO EMPTY:** The new generation of the WaveBrake® mop bucket is designed to safely empty water with less effort. Integrated handles, sink ledge, and a pour spout provide control while lifting and emptying, for a safe and stable emptying process.
- **DESIGNED TO LAST:** The new generation WaveBrake® wringer is designed and built to the highest of quality standards. WaveBrake® wringers have an industry-leading warranty of 5-years.
- **INTEGRATED HANDLES AND SINK LEDGE:** Lift and empty the mop bucket easily, with less strain.
- **POUR SPOUT:** Helps prevent water from spilling onto floors while emptying dirty water, to help floor remain dry and safe.

COLORS AVAILABLE: 



WaveBrake® Side-Press Bucket and Wringer

NO.	COLOR	DESCRIPTION	U.S. DIMENSIONS	U.S. SHIP WT	U.S. CAPACITY	METRIC DIMENSIONS	METRIC SHIP WT	METRIC CAPACITY	PACK
FG748000YEL	Yellow	26 qt WaveBrake® Side-Press Bucket and Wringer	18.88" l x 16.63" w x 23.5" h	20.67 lb	26 qt	47.94 cm x 42.23 cm x 59.69 cm	9.38 kg	24.61 L	1
FG758088YEL	Yellow	35 qt WaveBrake® Side-Press Bucket and Wringer	20.31" l x 16.44" w x 21.63" h	21.55 lb	35 qt	51.59 cm x 41.75 cm x 54.93 cm	9.78 kg	33.12 L	1
FG758088BRN	Brown	35 qt WaveBrake® Side-Press Bucket and Wringer	20.31" l x 16.44" w x 21.63" h	21.55 lb	35 qt	51.59 cm x 41.75 cm x 54.93 cm	9.78 kg	33.12 L	1
FG758888BLUE	Blue	35 qt WaveBrake® Side-Press Bucket and Wringer	20.31" l x 16.44" w x 21.63" h	21.55 lb	35 qt	51.59 cm x 41.75 cm x 54.93 cm	9.78 kg	33.12 L	1
FG758888RED	Red	35 qt WaveBrake® Side-Press Bucket and Wringer	20.31" l x 16.44" w x 21.63" h	21.55 lb	35 qt	51.59 cm x 41.75 cm x 54.93 cm	9.78 kg	33.12 L	1
FG758888GRN	Green	35 qt WaveBrake® Side-Press Bucket and Wringer	20.31" l x 16.44" w x 21.63" h	21.55 lb	35 qt	51.59 cm x 41.75 cm x 54.93 cm	9.78 kg	33.12 L	1
1863896	Black	35 qt WaveBrake® Side-Press Bucket and Wringer, Executive Series™	30.19" l x 16.56" w x 20.50" h	24.37 lb	35 qt	76.68 cm x 42.07 cm x 52.07 cm	11.05 kg	33.12 L	1
2031764	Yellow	35 qt WaveBrake® Side-Press Bucket and Wringer with Drain	20.31" l x 16.44" w x 21.63" h	21.55 lb	35 qt	51.59 cm x 41.75 cm x 54.93 cm	9.78 kg	33.12 L	1
FG618688YEL	Yellow	44 qt WaveBrake® Side-Press Bucket and Wringer with Drain	23.63" l x 16.81" w x 19.75" h	21.60 lb	44 qt	60.00 cm x 42.70 cm x 50.17 cm	9.80 kg	41.64 L	1

WaveBrake® Down-Press Bucket and Wringer

NO.	COLOR	DESCRIPTION	U.S. DIMENSIONS	U.S. SHIP WT	U.S. CAPACITY	METRIC DIMENSIONS	METRIC SHIP WT	METRIC CAPACITY	PACK
FG757788YEL	Yellow	35 qt WaveBrake® Down-Press Bucket and Wringer	20.31" l x 16.44" w x 21.63" h	21.55 lb	35 qt	51.59 cm x 41.75 cm x 54.93 cm	9.78 kg	33.12 L	1
FG757788BRN	Brown	35 qt WaveBrake® Down-Press Bucket and Wringer	20.31" l x 16.44" w x 21.63" h	21.55 lb	35 qt	51.59 cm x 41.75 cm x 54.93 cm	9.78 kg	33.12 L	1
FG757888BLUE	Blue	35 qt WaveBrake® Down-Press Bucket and Wringer	20.31" l x 16.44" w x 21.63" h	21.55 lb	35 qt	51.59 cm x 41.75 cm x 54.93 cm	9.78 kg	33.12 L	1
FG757888RED	Red	35 qt WaveBrake® Down-Press Bucket and Wringer	20.31" l x 16.44" w x 21.63" h	21.55 lb	35 qt	51.59 cm x 41.75 cm x 54.93 cm	9.78 kg	33.12 L	1
FG757888GRN	Green	35 qt WaveBrake® Down-Press Bucket and Wringer	20.31" l x 16.44" w x 21.63" h	21.55 lb	35 qt	51.59 cm x 41.75 cm x 54.93 cm	9.78 kg	33.12 L	1
1863898	Black	35 qt WaveBrake® Down-Press Bucket and Wringer, Executive Series™	30.19" l x 16.56" w x 27.75" h	22.30 lb	35 qt	76.68 cm x 42.07 cm x 70.49 cm	10.12 kg	33.12 L	1
FG757688YEL	Yellow	44 qt WaveBrake® Down-Press Bucket and Wringer with Drain	28.81" l x 17.00" w x 23.50" h	27.25 lb	44 qt	60.48 cm x 43.18 cm x 59.69 cm	12.36 kg	41.64 L	1

UTILITY REFUSE AND RECYCLING

DECORATIVE REFUSE

CLEANING

MATERIAL HANDLING

WASHROOM

FOODSERVICE

ACCESSORIES & INDEX



WaveBrake® Institutional Bucket and Wringer

With features that surpass traditional mop buckets, the new generation of WaveBrake® helps to clean floors with less effort to get the job done safer, without sacrificing quality and durability.

- **IMPROVE SAFETY AND PRODUCTIVITY:** Patented WaveBrake® baffles result in less splashing while mopping and maneuvering, helping to create a safer environment for patrons and staff. Additionally, water stays in the bucket, eliminating unnecessary trips to the storage closet to fill up the bucket, enhancing productivity.
- **80% LESS SPLASHING:** Molded-in WaveBrake® baffles disrupt wave formation, reducing splash up to 80% versus leading competitors.* (*Versus competitive U.S. 35 qt single compartment mop bucket and wringer, not including divider bucket and accessories.)
- **CONVENIENT TO EMPTY:** The new generation of the WaveBrake® mop bucket is designed to safely empty water with less effort. Integrated handles, sink ledge, and a pour spout provide control while lifting and emptying, for a safe and stable emptying process.
- **INTEGRATED HANDLES AND SINK LEDGE:** Lift and empty the mop bucket easily, with less strain.
- **POUR SPOUT:** Helps prevent water from spilling onto floors while emptying dirty water, to help floor remain dry and safe.



NO.	COLOR	DESCRIPTION	U.S. DIMENSIONS	U.S. SHIP WT	U.S. CAPACITY	METRIC DIMENSIONS	METRIC SHIP WT	METRIC CAPACITY	PACK
FG759088YEL	Yellow	35 qt WaveBrake® Institutional Bucket and Sieve Wringer	20.13" l x 16.75" w x 20.50" h	13.95 lb	35 qt	51.12 cm x 42.55 cm x 52.07 cm	6.33 kg	33.12 L	1

WaveBrake® Bucket and Casters

With features that surpass traditional mop buckets, the new generation of WaveBrake® helps to clean floors with less effort to get the job done safer, without sacrificing quality and durability.

- **IMPROVE SAFETY AND PRODUCTIVITY:** Patented WaveBrake® baffles result in less splashing while mopping and maneuvering, helping to create a safer environment for patrons and staff. Additionally, water stays in the bucket, eliminating unnecessary trips to the storage closet to fill up the bucket, enhancing productivity.
- **80% LESS SPLASHING:** Molded-in WaveBrake® baffles disrupt wave formation, reducing splash up to 80% versus leading competitors.* (*Versus competitive U.S. 35 qt single compartment mop bucket and wringer, not including divider bucket and accessories.)
- **CONVENIENT TO EMPTY:** The new generation of the WaveBrake® mop bucket is designed to safely empty water with less effort. Integrated handles, sink ledge, and a pour spout provide control while lifting and emptying, for a safe and stable emptying process.
- **INTEGRATED HANDLES AND SINK LEDGE:** Lift and empty the mop bucket easily, with less strain.
- **POUR SPOUT:** Helps prevent water from spilling onto floors while emptying dirty water, to help floor remain dry and safe.
- **SECURE WRINGER CONNECTIONS:** Integrated wringer-guides ensure a secure connection to mop bucket, providing stability while wringing and maneuvering, to help prevent spills.



2064914



2031763

NO.	COLOR	DESCRIPTION	U.S. DIMENSIONS	U.S. SHIP WT	U.S. CAPACITY	METRIC DIMENSIONS	METRIC SHIP WT	METRIC CAPACITY	PACK
2064996	Yellow	26 qt WaveBrake® Bucket and Casters	19.25" l x 16.01" w x 15.17" h	38.07 lb	26 qt	48.90 cm x 40.77 cm x 38.54 cm	17.27 kg	24.61 L	4
2064914	Yellow	35 qt WaveBrake® Bucket and Casters	20.25" l x 16.05" w x 17.29" h	42.99 lb	35 qt	51.44 cm x 40.77 cm x 43.92 cm	19.50 kg	33.12 L	4
2031763	Yellow	35 qt WaveBrake® Bucket and Casters with Drain	20.13" l x 16.75" w x 18.25" h	12.02 lb	35 qt	51.12 cm x 42.55 cm x 46.36 cm	5.45 kg	33.12 L	1

UTILITY REFUSE AND RECYCLING

DECORATIVE REFUSE

CLEANING

MATERIAL HANDLING

WASHROOM

FOODSERVICE

ACCESSORIES & INDEX

Tandem™ 31-Qt Bucket and Wringer Combo

All-in-one compact design for effective wringing and no more lost parts.

- One-piece design: integrated bucket and wringer
- Holes in both wringing plates force more water from mop in less time
- 2½" casters for excellent maneuverability
- Built-in lift handles on bottom of bucket make lifting and emptying easier
- Accepts up to 24-oz mops



NO.	COLOR	DESCRIPTION	U.S. DIMENSIONS	U.S. SHIP WT/CTN	U.S. CAPACITY	METRIC DIMENSIONS	METRIC SHIP WT	METRIC CAPACITY	PACK
FG738000	YEL	Tandem™ 31-Qt Bucket and Wringer Combo	22.63" l x 13.25" w x 32.25" h	11.8 lb	31 qt	57.5 cm x 33.7 cm x 81.9 cm	5.4 kg	29 L	1

WaveBrake® Wringers

The new generation WaveBrake® wringer is designed and built to the highest of quality standards. WaveBrake® wringers have an industry-leading warranty of 5-years.

- 5-YEAR WRINGER GUARANTEE: The side-press and down-press wringers are designed to last 5-years or 200,000 cycles.
- SECURE WRINGER CONNECTIONS: Integrated wringer-guides ensure a secure connection to mop bucket, providing stability while wringing and maneuvering, to help prevent spills.
- WRINGS A VARIETY OF MOP SIZES: Wringer effectively wrings a variety of mop sizes, ranging from XS – XL (10oz – 32oz).
- DURABLE WRINGER HANDLE: Handle is made from steel, with a comfort grip for long-lasting durability

COLORS AVAILABLE:



2064915



2064959

WaveBrake® Dirty Water Buckets

Keeping the dirty water separate from clean water, the dirty water bucket helps to reduce the potential for cross-contamination. Executive Series™ WaveBrake® models include the dirty water bucket as standard.

COLORS AVAILABLE:



2064907

NO.	COLOR	DESCRIPTION	U.S. DIMENSIONS	U.S. SHIP WT	U.S. CAPACITY	METRIC DIMENSIONS	METRIC SHIP WT	METRIC CAPACITY	PACK
2064915	Yellow	WaveBrake® Side-Press Wringer	15.75" l x 13.38" w x 31.13" h	22.30 lb	N/A	40.01 cm x 33.97 cm x 79.06 cm	10.12 kg	N/A	2
2064885	Brown	WaveBrake® Side-Press Wringer	15.75" l x 13.38" w x 31.13" h	22.30 lb	N/A	40.01 cm x 33.97 cm x 79.06 cm	10.12 kg	N/A	2
2064888	Blue	WaveBrake® Side-Press Wringer	15.75" l x 13.38" w x 31.13" h	22.30 lb	N/A	40.01 cm x 33.97 cm x 79.06 cm	10.12 kg	N/A	2
2064884	Red	WaveBrake® Side-Press Wringer	15.75" l x 13.38" w x 31.13" h	22.30 lb	N/A	40.01 cm x 33.97 cm x 79.06 cm	10.12 kg	N/A	2
2064912	Green	WaveBrake® Side-Press Wringer	15.75" l x 13.38" w x 31.13" h	22.30 lb	N/A	40.01 cm x 33.97 cm x 79.06 cm	10.12 kg	N/A	2
2064960	Black	WaveBrake® Side-Press Wringer, Executive Series™	15.75" l x 13.38" w x 31.13" h	22.30 lb	N/A	40.01 cm x 33.97 cm x 79.06 cm	10.12 kg	N/A	2
2064959	Yellow	WaveBrake® Down-Press Wringer	12.81" l x 11.94" w x 39.88" h	21.27 lb	N/A	32.54 cm x 30.32 cm x 101.28 cm	9.65 kg	N/A	2
2065003	Brown	WaveBrake® Down-Press Wringer	12.81" l x 11.94" w x 39.88" h	21.27 lb	N/A	32.54 cm x 30.32 cm x 101.28 cm	9.65 kg	N/A	2
2064999	Blue	WaveBrake® Down-Press Wringer	12.81" l x 11.94" w x 39.88" h	21.27 lb	N/A	32.54 cm x 30.32 cm x 101.28 cm	9.65 kg	N/A	2
2065001	Red	WaveBrake® Down-Press Wringer	12.81" l x 11.94" w x 39.88" h	21.27 lb	N/A	32.54 cm x 30.32 cm x 101.28 cm	9.65 kg	N/A	2
2064953	Green	WaveBrake® Down-Press Wringer	12.81" l x 11.94" w x 39.88" h	21.27 lb	N/A	32.54 cm x 30.32 cm x 101.28 cm	9.65 kg	N/A	2
2064994	Black	WaveBrake® Down-Press Wringer, Executive Series™	12.81" l x 11.94" w x 39.88" h	21.27 lb	N/A	32.54 cm x 30.32 cm x 101.28 cm	9.65 kg	N/A	2
2064907	Red	35 qt WaveBrake® Dirty Water Bucket	15.19" l x 9.75" w x 14.00" h	14.95 lb	35 qt	38.58 cm x 24.77 cm x 35.56 cm	6.78 kg	33.12 L	6
2064905	Gray	35 qt WaveBrake® Dirty Water Bucket	15.19" l x 9.75" w x 14.00" h	14.95 lb	37 qt	38.58 cm x 24.77 cm x 35.56 cm	6.78 kg	33.12 L	6



MOP CONSTRUCTION DEFINED

YARN TYPE

Mop yarn type is the most impactful driver of mop launderability, absorbency, durability, and release. Understanding mop yarn type helps drive proper mop selection for varying applications.



MICROFIBER TUBE

Most durable, stands up to abrasive cleaning and heavy-duty scrubbing with excellent absorbency.



FINISH

Designed to provide smooth and even release of chemical and floor finish. Less linting compared to rayon.



MICROFIBER

Highly durable, non-abrasive general-purpose mop.



RAYON

General-purpose mopping. Reliable liquid absorption. Highest quality of yarn. Resists mildew growth, extending mop life and white appearance.



BLEND SHRINKLESS®

General-purpose mopping. Pre-laundered for reduced shrinking. Longer-lasting and less linting compared to cotton. Highly absorbent/no break-in required.



SYNTHETIC BLEND

All-synthetic mop yarns resist abrasive floor surfaces.



BLEND

General-purpose mopping. Longer-lasting and less linting compared to cotton. Highly absorbent/no break-in required.



CLEAN ROOM

Made of woven rayon/polyester fabric that will not fray or lint. For use in Class 10,000 and higher industrial applications.



COTTON

General-purpose mopping. Least expensive yarn option. Reliable liquid absorption. Requires break-in, dries slowly, may lint.



ROUGH-FLOOR

Knitted fleece cotton/polyester blend yarn for highly abrasive surfaces. High absorbency.



NON-WOVEN

General-purpose mopping. Least expensive wet mop option. Highly absorbent. Requires no break-in and delivers reduced linting versus cotton. Not launderable.



NYLON

Non-linting, continuous filament yarn for finishing applications. High launderability.

When ordering products with **BOLD** color codes, please specify color code after the product number. Refer to the Standard Color Guide at the back of the catalog.

HEADBAND TYPE

Headbands drive mop handle selection and can be made of cloth or mesh. Mesh headbands dry faster and can sometimes be used as a scrubbing tool due to the abrasive nature of the material.



1" HEADBAND

Most optimal with side-gate Invader® Wet Mop Handle.



5" HEADBAND

Most optimal with clamp-style Gripper® Wet Mop Handle.



UNIVERSAL HEADBAND

Compatible with Gripper® and Invader® Wet Mop Handles.



BOLT-ON HEADBAND

Works with Bolt-on Wet Mop Handle.

TAILBAND TYPE

Tailbands prevent tangling and improve floor coverage for more efficient mopping. Not all mops have tailbands.



WOVEN TAILBAND

Allows for commercial laundering. Most expensive type of tailband.



YARN TAILBAND

Requires handwashing or limited residential laundering. Economical tailband choice.



NO TAILBAND

Requires handwashing only.

END TYPE

Mop ends can be looped or cut, and ultimately impact mop launderability, fraying, linting, and unraveling.



LOOPED END

Reduces fraying, linting, and unraveling. Allows for laundering, extending lifetime. Generally more expensive.



CUT END

Economical and practical general-purpose mop. Ends may fray and unravel. Does not incorporate tailband, covering less area. Disposable or hand wash.

REFERENCE GUIDE

Use the following guide to choose the best Rubbermaid Commercial Products Wet Mops for your facility.

		REFERENCE		FLOOR TYPE/APPLICATION		
			PAGE #	VINYL TILE, LAMINATE, SMOOTH CERAMIC TILE	ANTI-SLIP TILE, TERRAZZO, PAVER & QUARRY STONE	RUBBER, HARDWOOD, SMOOTH CONCRETE
GENERAL	BEST	WEB FOOT® MICROFIBER TUBE WET MOP	103	•	•	•
		WEB FOOT® MICROFIBER STRING WET MOP	103	•	•	•
		WEB FOOT® BLEND SHRINKLESS® WET MOP	104	•	•	•
		WEB FOOT® BLEND SCRUBBING WET MOP	104	•	•	•
		WEB FOOT® BLEND WET MOP	104	•	•	•
		MAXIMIZER™ MICROFIBER BLEND WET MOP	102	•	•	•
	BETTER	MAXIMIZER™ BLEND WET MOP	102	•	•	•
		SWINGER LOOP® WET MOP	105	•	•	•
		SWINGER LOOP® SHRINKLESS® WET MOP	105	•	•	•
		SUPER STITCH® BLEND SCRUBBING WET MOP	108	•	•	•
		SUPER STITCH® BLEND WET MOP	109	•	•	•
		SUPER STITCH® COTTON SCRUBBING WET MOP	107	•	•	•
		SUPER STITCH® COTTON WET MOP	108	•	•	•
		UNIVERSAL HEADBAND BLEND WET MOP	109	•	•	•
	GOOD	UNIVERSAL HEADBAND COTTON WET MOP	110	•	•	•
		DISPOSABLE WET MOP	111	•	•	•
		DURA PRO CUT-END BLEND WET MOP	110	•	•	•
		BOLT-ON CUT-END BLEND WET MOP	112	•	•	•
DURA PRO CUT-END COTTON WET MOP		111	•	•	•	
VALUE PRO CUT-END COTTON WET MOP		112	•	•	•	
SPECIALTY	BEST	WEB FOOT® FINISH WET MOP	105	•	•	•
		NYLON FINISH WET MOP	114	•	•	•
		CLEAN ROOM MAINTENANCE WET MOP	114	•	•	•
		ROUGH-FLOOR WET MOP	114	•	•	•
		DISPOSABLE WET MOP	111	•	•	•
	BETTER	SWINGER LOOP® BLEND FINISH WET MOP	107	•	•	•
		SUPER STITCH® BLEND FINISH WET MOP	108	•	•	•
		SUPER STITCH® RAYON FINISH WET MOP	107	•	•	•
		SYNTHETIC BLEND HOT WET MOP	113	•	•	•
		UNIVERSAL HEADBAND RAYON FINISH WET MOP	109	•	•	•
	GOOD	DURA PRO RAYON FINISH WET MOP	110	•	•	•
		BOLT-ON RAYON FINISH WET MOP	112	•	•	•
		VALUE PRO RAYON FINISH WET MOP	112	•	•	•

When ordering products with **BOLD** color codes, please specify color code after the product number. Refer to the Standard Color Guide at the back of the catalog.

MOP CONSTRUCTION				MOPPING ATTRIBUTES	
END TYPE	TAILBAND TYPE	YARN TYPE	HEADBAND SIZE	LAUNDERABILITY	SUSTAINABILITY
LOOPEd	WOVEN	MICROFIBER	1", 5"	UP TO 200 COMMERCIAL LAUNDERINGS	UP TO 50% RECYCLED CONTENT
LOOPEd	WOVEN	MICROFIBER	1", 5"	UP TO 100 COMMERCIAL LAUNDERINGS	UP TO 49% RECYCLED CONTENT
LOOPEd	WOVEN	BLEND	1", 5"	UP TO 75 COMMERCIAL LAUNDERINGS	UP TO 80% RECYCLED CONTENT
LOOPEd	WOVEN	BLEND	UNIVERSAL	UP TO 75 COMMERCIAL LAUNDERINGS	UP TO 80% RECYCLED CONTENT
LOOPEd	WOVEN	BLEND	1", 5"	UP TO 75 COMMERCIAL LAUNDERINGS	UP TO 80% RECYCLED CONTENT
LOOPEd	WOVEN	BLEND	UNIVERSAL	UP TO 100 COMMERCIAL LAUNDERINGS	UP TO 43% RECYCLED CONTENT
LOOPEd	WOVEN	BLEND	UNIVERSAL	UP TO 50 COMMERCIAL LAUNDERINGS	UP TO 75% RECYCLED CONTENT
LOOPEd	WOVEN	BLEND	1", 5"	UP TO 50 COMMERCIAL LAUNDERINGS	UP TO 100% RECYCLED CONTENT
LOOPEd	WOVEN	BLEND	1", 5"	UP TO 50 COMMERCIAL LAUNDERINGS	UP TO 100% RECYCLED CONTENT
LOOPEd	YARN	BLEND	UNIVERSAL	UP TO 50 RESIDENTIAL LAUNDERINGS	UP TO 100% RECYCLED CONTENT
LOOPEd	YARN	BLEND	1", 5"	UP TO 50 RESIDENTIAL LAUNDERINGS	UP TO 100% RECYCLED CONTENT
LOOPEd	YARN	COTTON	UNIVERSAL	UP TO 50 RESIDENTIAL LAUNDERINGS	UP TO 100% RECYCLED CONTENT
LOOPEd	YARN	COTTON	1"	UP TO 50 RESIDENTIAL LAUNDERINGS	UP TO 100% RECYCLED CONTENT
LOOPEd	YARN	BLEND	UNIVERSAL	UP TO 50 RESIDENTIAL LAUNDERINGS	UP TO 100% RECYCLED CONTENT
LOOPEd	YARN	COTTON	UNIVERSAL	UP TO 50 RESIDENTIAL LAUNDERINGS	UP TO 100% RECYCLED CONTENT
CUT	NON-WOVEN	DISPOSABLE	1", 5"	0 LAUNDERINGS; SINGLE USE DISPOSABLE	UP TO 99% RECYCLED CONTENT
CUT	NONE	BLEND	1", 5"	HAND WASH ONLY	UP TO 100% RECYCLED CONTENT
CUT	NONE	BLEND	BOLT-ON	HAND WASH ONLY	UP TO 100% RECYCLED CONTENT
CUT	NONE	COTTON	1", 5"	HAND WASH ONLY	UP TO 100% RECYCLED CONTENT
CUT	NONE	COTTON	1", 5"	HAND WASH ONLY	UP TO 100% RECYCLED CONTENT

LOOPEd	TAPELESS	BLEND	1"	UP TO 75 COMMERCIAL LAUNDERINGS	UP TO 74% RECYCLED CONTENT
LOOPEd	YARN	NYLON	1"	UP TO 75 COMMERCIAL LAUNDERINGS	NO RECYCLED CONTENT
LOOPEd	WOVEN	BLEND	5"	UP TO 75 COMMERCIAL LAUNDERINGS	NO RECYCLED CONTENT
LOOPEd	WOVEN	BLEND	5"	UP TO 75 COMMERCIAL LAUNDERINGS	NO RECYCLED CONTENT
N/A	N/A	DISPOSABLE	ONE SIZE	0 LAUNDERINGS; SINGLE USE DISPOSABLE	UP TO 99% RECYCLED CONTENT
LOOPEd	TAPELESS	BLEND	1"	UP TO 50 COMMERCIAL LAUNDERINGS	UP TO 74% RECYCLED CONTENT
LOOPEd	YARN	BLEND	1", 5"	UP TO 50 RESIDENTIAL LAUNDERINGS	UP TO 74% RECYCLED CONTENT
LOOPEd	YARN	RAYON	1", 5"	UP TO 50 RESIDENTIAL LAUNDERINGS	UP TO 75% RECYCLED CONTENT
CUT	NONE	BLEND	1", 5"	HAND WASH ONLY	UP TO 70% RECYCLED CONTENT
LOOPEd	NONE	RAYON	UNIVERSAL	UP TO 50 RESIDENTIAL LAUNDERINGS	UP TO 75% RECYCLED CONTENT
CUT	NONE	RAYON	1", 5"	HAND WASH ONLY	UP TO 75% RECYCLED CONTENT
CUT	NONE	RAYON	BOLT-ON	HAND WASH ONLY	UP TO 75% RECYCLED CONTENT
CUT	NONE	RAYON	1"	HAND WASH ONLY	UP TO 75% RECYCLED CONTENT



Maximizer™ Microfiber Blend Mops

The Maximizer™ Microfiber Mop provides best cost of ownership and highest level of cleaning power.

- The specially designed tailband delivers 30% greater spread in use
- 25% less weight means less effort when mopping and lifting
- The unique Maximizer™ Blend delivers the highest absorbency ratio of any mop in its class
- Absorbs up to 3X as much as cotton
- Industry-leading durability – Developed to withstand up to 100 commercial laundering cycles
- The universal headband is compatible with any traditional wet mop connection system and durable enough to withstand scrubbing applications



1924814

NO.	COLOR	DESCRIPTION	U.S. HEADBAND SIZE	U.S. SHIP WT/CTN	MOP SIZE	METRIC HEADBAND SIZE	METRIC SHIP WT/CTN	HEADBAND COLOR	PACK
1924813	BLUE	Maximizer™ Microfiber Mop	Universal	6.01 lb	Medium	Universal	2.73 kg	Black	6
1924812	BLUE	Maximizer™ Microfiber Mop	Universal	6.93 lb	Large	Universal	3.14 kg	Black	6
1924815	GREEN	Maximizer™ Microfiber Mop	Universal	6.01 lb	Medium	Universal	2.73 kg	Black	6
1924814	GREEN	Maximizer™ Microfiber Mop	Universal	6.93 lb	Large	Universal	3.14 kg	Black	6
1924817	RED	Maximizer™ Microfiber Mop	Universal	6.01 lb	Medium	Universal	2.73 kg	Black	6
1924816	RED	Maximizer™ Microfiber Mop	Universal	6.93 lb	Large	Universal	3.14 kg	Black	6

Maximizer™ Blend Mops

The unique Maximizer™ Blend delivers the highest absorbency ratio of any mop in its class

- The specially designed tailband delivers 30% greater spread in use
- 25% less weight means less effort when mopping and lifting
- The unique Maximizer™ Blend delivers the highest absorbency ratio of any mop in its class
- Absorbs up to 3X as much as cotton
- Industry-leading durability – Developed to withstand up to 50 commercial laundering cycles
- The universal headband is compatible with any traditional wet mop connection system and durable enough to withstand scrubbing applications



1924783

NO.	COLOR	DESCRIPTION	U.S. HEADBAND SIZE	U.S. SHIP WT/CTN	MOP SIZE	METRIC HEADBAND SIZE	METRIC SHIP WT/CTN	HEADBAND COLOR	PACK
1924783	BLUE	Maximizer™ Blend Mop	Universal	6.01 lb	Medium	Universal	2.73 kg	Black	6
1924782	BLUE	Maximizer™ Blend Mop	Universal	6.93 lb	Large	Universal	3.14 kg	Black	6
1924787	RED	Maximizer™ Blend Mop	Universal	6.01 lb	Medium	Universal	2.73 kg	Black	6
1924786	RED	Maximizer™ Blend Mop	Universal	6.93 lb	Large	Universal	3.14 kg	Black	6

UTILITY REFUSE AND RECYCLING

DECORATIVE REFUSE

CLEANING

MATERIAL HANDLING

WASHROOM

FOODSERVICE

ACCESSORIES & INDEX

Web Foot® Mops

Web Foot® offers the best performance in the industry with maximum absorbency, ultimate durability, fast drying, and superior launderability.

- Contains antimicrobial product protection to inhibit the growth of bacteria that causes odors and stains and shortens useful product life
- Looped ends and tailbands reduce tangling for like-new performance after every laundering
- Prelaunched and preshrunk for longer product life
- Colorfast colors will not fade with repeated launderings
- Suitable for healthcare and general commercial maintenance applications
- Premium launderability, up to 75 launderings

BUILT-IN ANTIMICROBIAL PROTECTION

Rubbermaid Commercial Web Foot® mops incorporate antimicrobials directly into the yarn. Mops contain a built-in antimicrobial protection protecting the mop from bacteria, mold, and mildew growth, leaving floors dirt-free and lengthening the mop's useful life.

Web Foot® Microfiber Tube Mops

Designed to have greater floor contact and improved absorbency.

- Constructed with a blend of continuous-filament microfiber and polyester
- Superior absorbency and release characteristics
- Tube design reduces drag for increased productivity
- Recycled content: up to 50% PET Plastic
- Premium launderability, up to 200 launderings

BLEACH-SAFE
in hot & cold water



FOR MICROFIBER FLAT MOPS, SEE MICROFIBER MOPS.



FGT81206

NO.	COLOR	DESCRIPTION	U.S. HEADBAND SIZE	U.S. SHIP WT/CTN	MOP SIZE	METRIC HEADBAND SIZE	METRIC SHIP WT/CTN	PACK
FGT81206	GR00	Web Foot® Microfiber Tube Mop	1"	4.5 lb	Medium	2.5 cm	2 kg	6
FGT81306	GR00	Web Foot® Microfiber Tube Mop	1"	4.8 lb	Large	2.5 cm	2.2 kg	6
FGT85206	GR00	Web Foot® Microfiber Tube Mop	5"	4.5 lb	Medium	12.7 cm	2 kg	6
FGT85306	GR00	Web Foot® Microfiber Tube Mop	5"	4.8 lb	Large	12.7 cm	2.2 kg	6

Web Foot® Microfiber String Mops

- Highly durable and absorbent for extra-long life
- Constructed with a blend of continuous-filament microfiber and antimicrobial yarn
- Premium launderability, up to 100 launderings

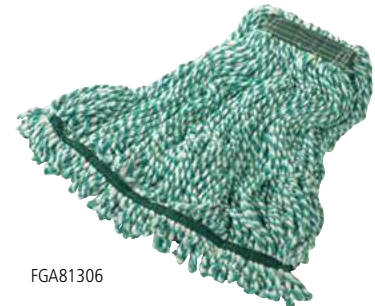

FGA81306

NO.	COLOR	DESCRIPTION	U.S. HEADBAND SIZE	U.S. SHIP WT/CTN	MOP SIZE	METRIC HEADBAND SIZE	METRIC SHIP WT/CTN	HEADBAND COLOR	PACK
FGA81206	GR00	Web Foot® Microfiber String Mop	1"	4.85 lb		2.54 cm	2.2 kg	Green	6
FGA85206	GR00	Web Foot® Microfiber String Mop	5"	5.95 lb		12.7 cm	2.7 kg	Green	6
FGA85306	GR00	Web Foot® Microfiber String Mop	5"	5.62 lb		12.7 cm	2.6 kg	Green	6
FGA81306	GR00	Web Foot® Microfiber String Mop	1"	5.62 lb		2.54 cm	2.6 kg	Green	6

UTILITY REFUSE AND RECYCLING

DECORATIVE REFUSE

CLEANING

MATERIAL HANDLING

WASHROOM

FOODSERVICE

ACCESSORIES & INDEX



Web Foot® Blend Shrinkless® Mops

- Balanced 4-ply blend of cotton and synthetic yarn is prelaundered
- Woven tailband provides more floor coverage
- PVC-coated mesh headband prohibits moisture penetration and resists chemicals
- Recycled content: colors are up to 35% post-industrial cotton and 45% PET plastic; white is up to 35% post-industrial cotton
- Looped ends reduce fraying, linting, and unraveling
- Premium launderability, up to 75 launderings



FGA25206

NO.	COLOR	DESCRIPTION	U.S. HEADBAND SIZE	U.S. SHIP WT/CTN	MOP SIZE	METRIC HEADBAND SIZE	METRIC SHIP WT/CTN	HEADBAND COLOR	PACK
FGA21106	GR00, WH00, BL00	Web Foot® Shrinkless® Wet Mop	1"	5.8 lb	Small	2.5 cm	2.6 kg	YEL	6
FGA21206	GR00, WH00, BL00	Web Foot® Shrinkless® Wet Mop	1"	7.6 lb	Medium	2.5 cm	3.4 kg	GRN	6
FGA21306	GR00, WH00, BL00	Web Foot® Shrinkless® Wet Mop	1"	10.8 lb	Large	2.5 cm	4.9 kg	RED	6
FGA25106	GR00, WH00, BL00, OR00	Web Foot® Shrinkless® Wet Mop	5"	5.9 lb	Small	12.7 cm	2.7 kg	YEL	6
FGA25206	GR00, WH00, BL00, OR00	Web Foot® Shrinkless® Wet Mop	5"	7.7 lb	Medium	12.7 cm	3.5 kg	GRN	6
FGA25306	GR00, WH00, BL00, OR00	Web Foot® Shrinkless® Wet Mop	5"	11.0 lb	Large	12.7 cm	5 kg	RED	6

Web Foot® Blend Scrubbing Wet Mops

The Scrubbing Wet Mop features an integrated scrubbing headband that removes stuck-on messes faster without interrupting the mopping process.

- Integrated scrubbing headband removes stuck-on debris 2x faster than a traditional Rubbermaid Commercial Products wet mop.
- Universal scrubbing headband is compatible with side-loading Invader® and clamp-style Gripper® handles.
- Double-sided and securely sewn-in scrubbing headband lasts the lifetime of the mop.
- Designed for effective scrubbing without scratching on a variety of floor types, including laminate, linoleum, vinyl, and light and dark hardwood.



2036140

NO.	COLOR	DESCRIPTION	U.S. HEADBAND SIZE	U.S. SHIP WT/CTN	MOP SIZE	METRIC HEADBAND SIZE	METRIC SHIP WT/CTN	HEADBAND COLOR	PACK
2036140	Green	Web Foot® Blend Scrubbing Wet Mop	Universal	8.07 lb	Large	Universal	3.66 kg	Green	6
2036132	White	Web Foot® Blend Scrubbing Wet Mop	Universal	8.07 lb	Large	Universal	3.66 kg	Green	6
2036134	Blue	Web Foot® Blend Scrubbing Wet Mop	Universal	8.07 lb	Large	Universal	3.66 kg	Green	6
2036139	Orange	Web Foot® Blend Scrubbing Wet Mop	Universal	8.07 lb	Large	Universal	3.66 kg	Green	6
2036141	Green	Web Foot® Blend Scrubbing Wet Mop	Universal	6.75 lb	Medium	Universal	3.06 kg	Green	6
2036133	White	Web Foot® Blend Scrubbing Wet Mop	Universal	6.75 lb	Medium	Universal	3.06 kg	Green	6
2036135	Blue	Web Foot® Blend Scrubbing Wet Mop	Universal	6.75 lb	Medium	Universal	3.06 kg	Green	6
2036137	Orange	Web Foot® Blend Scrubbing Wet Mop	Universal	6.75 lb	Medium	Universal	3.06 kg	Green	6

Web Foot® Blend Mops

- Balanced blend of cotton and synthetic fibers delivers up to five times the absorbency of cotton mops
- Looped ends reduce fraying, linting, and unraveling
- Woven tailband provides more floor coverage
- Recycled content: colors are up to 35% post-industrial cotton and 45% PET plastic; white is up to 35% post-industrial cotton
- **Shipped as compact mop packages**
- Premium launderability, up to 75 launderings



FGA15206

NO.	COLOR	DESCRIPTION	U.S. HEADBAND SIZE	U.S. SHIP WT/CTN	MOP SIZE	METRIC HEADBAND SIZE	METRIC SHIP WT/CTN	HEADBAND COLOR	PACK
FGA11106	WH00, BL00	Web Foot® Wet Mop	1"	4.5 lb	Small	2.5 cm	2 kg	YEL	6
FGA11206	GR00, WH00, BL00, OR00	Web Foot® Wet Mop	1"	6.0 lb	Medium	2.5 cm	2.7 kg	GRN	6
FGA11306	GR00, WH00, BL00, OR00	Web Foot® Wet Mop	1"	8.6 lb	Large	2.5 cm	3.9 kg	RED	6
FGA15106	GR00, WH00, BL00	Web Foot® Wet Mop	5"	4.5 lb	Small	12.7 cm	2 kg	YEL	6
FGA15206	GR00, WH00, BL00, OR00	Web Foot® Wet Mop	5"	6.0 lb	Medium	12.7 cm	2.7 kg	GRN	6
FGA15306	GR00, WH00, BL00, OR00	Web Foot® Wet Mop	5"	8.6 lb	Large	12.7 cm	3.9 kg	RED	6

Web Foot® Finish Mops

- Looped-end 4-ply synthetic yarn is designed for a controlled release of floor finish
- Tailband is sewn on the inside of mop and helps reduce the “drag” patterns common to most finish mops
- Recycled content: up to 74% PET plastic
- **Shipped as compact mop packages**
- Premium launderability, up to 75 launderings



FGA41206

NO.	COLOR	DESCRIPTION	U.S. HEADBAND SIZE	U.S. SHIP WT/CTN	MOP SIZE	METRIC HEADBAND SIZE	METRIC SHIP WT/CTN	HEADBAND COLOR	PACK
FGA41206	WH00	Web Foot® Finish Mop	1"	6.0 lb	Medium	2.5 cm	2.7 kg	WHT	6
FGA41306	WH00	Web Foot® Finish Mop	1"	8.6 lb	Large	2.5 cm	3.9 kg	WHT	6

Swinger Loop® Shrinkless® Wet Mops
 Prelaundered and preshrunk for increased mop performance after laundering.

- Balanced 4-ply blend of cotton and synthetic yarn for absorbency and strength
- Looped-end, woven tailbanded mop provides greater floor coverage
- PVC-coated mesh headband for longer product life
- Recycled content: colors are up to 65% post-industrial cotton and 35% PET plastic
- Standard launderability, up to 50 launderings



FGC25306

NO.	COLOR	DESCRIPTION	U.S. HEADBAND SIZE	U.S. SHIP WT/CTN	MOP SIZE	METRIC HEADBAND SIZE	METRIC SHIP WT/CTN	HEADBAND COLOR	PACK
FGC21206	GR00, BL00	Swinger Loop® Shrinkless® Wet Mop	1"	7.6 lb	Medium	2.5 cm	3.4 kg	GRN	6
FGC21306	GR00, WH00, BL00	Swinger Loop® Shrinkless® Wet Mop	1"	10.8 lb	Large	2.5 cm	4.9 kg	RED	6
FGC25206	GR00, WH00, BL00	Swinger Loop® Shrinkless® Wet Mop	5"	7.7 lb	Medium	12.7 cm	3.5 kg	GRN	6
FGC25306	GR00, WH00, BL00, OR00	Swinger Loop® Shrinkless® Wet Mop	5"	10.9 lb	Large	12.7 cm	4.9 kg	RED	6
FGC25406	WH00	Swinger Loop® Shrinkless® Wet Mop	5"	13.1 lb	X-Large	12.7 cm	5.9 kg	BLUE	6

Swinger Loop® Wet Mops

Looped-end, tailbanded mop for better floor coverage.

- Balanced 4-ply blend of cotton and synthetic yarn for absorbency and strength
- Launderable for long product life
- Recycled content: colors are up to 65% post-industrial cotton and 35% PET plastic
- **Shipped as compact mop packages**
- Standard launderability, up to 50 launderings



FGC15306

NO.	COLOR	DESCRIPTION	U.S. HEADBAND SIZE	U.S. SHIP WT/CTN	MOP SIZE	METRIC HEADBAND SIZE	METRIC SHIP WT/CTN	HEADBAND COLOR	PACK
FGC11106	WH00	Swinger Loop® Wet Mop	1"	4.5 lb	Small	2.5 cm	2 kg	YEL	6
FGC11206	GR00, WH00, BL00	Swinger Loop® Wet Mop	1"	6.0 lb	Medium	2.5 cm	2.7 kg	GRN	6
FGC11306	GR00, WH00, BL00	Swinger Loop® Wet Mop	1"	8.6 lb	Large	2.5 cm	3.9 kg	RED	6
FGC11406	WH00	Swinger Loop® Wet Mop	1"	10.9 lb	X-Large	2.5 cm	4.9 kg	BLUE	6
FGC15106	GR00, BL00	Swinger Loop® Wet Mop	5"	4.5 lb	Small	12.7 cm	2 kg	YEL	6
FGC15206	GR00, WH00, BL00	Swinger Loop® Wet Mop	5"	6.0 lb	Medium	12.7 cm	2.7 kg	GRN	6
FGC15306	GR00, WH00, BL00	Swinger Loop® Wet Mop	5"	8.6 lb	Large	12.7 cm	3.9 kg	RED	6
FGC15406	WH00, BL00	Swinger Loop® Wet Mop	5"	10.9 lb	X-Large	12.7 cm	4.9 kg	BLUE	6

UTILITY REFUSE AND RECYCLING

DECORATIVE REFUSE

CLEANING

MATERIAL HANDLING

WASHROOM

FOODSERVICE

ACCESSORIES & INDEX



UTILITY REFUSE
AND RECYCLING

DECORATIVE REFUSE

CLEANING

MATERIAL HANDLING

WASHROOM

FOODSERVICE

ACCESSORIES
& INDEX



SCRUBBING WET MOP



INTEGRATED

SCRUBBING HEADBAND

Removes stuck-on debris 2x faster than a traditional Rubbermaid Commercial Products wet mop.

DURABLE & UNIVERSAL

Double-sided and securely sewn-in scrubbing headband is compatible with side-loading Invader® and clamp-style Gripper® handles.

SAFE & EFFECTIVE

Designed for effective scrubbing without scratching on a variety of floor types, including laminate, linoleum, vinyl, and light and dark hardwood.

Swinger Loop® Finish Mops

Tightly twisted 8-ply yarn inhibits linting and provides a smooth, even application of floor finish.

- Tapeless tailband helps reduce streaking
- Compact mop packaging makes mop storage and inventory management more efficient
- Recycled content: 74% PET plastic
- **Shipped as compact mop packages**
- Standard launderability, up to 50 launderings



FGA41206

NO.	COLOR	DESCRIPTION	U.S. HEADBAND SIZE	U.S. SHIP WT/CTN	MOP SIZE	METRIC HEADBAND SIZE	METRIC SHIP WT/CTN	HEADBAND COLOR	PACK
FGC41206	WH00	Swinger Loop® Finish Mop	1"	6.0 lb	Medium	2.5 cm	2.7 kg	WHT	6
FGC41306	WH00	Swinger Loop® Finish Mop	1"	8.6 lb	Large	2.5 cm	3.9 kg	WHT	6

Super Stitch® Rayon Mops

Economical floor finish applicator.

- Looped ends and yarn tailband help reduce streaking
- Tightly twisted, 4-ply yarn helps reduce linting
- **Shipped as compact mop packages**
- Recycled content: up to 75% PET Plastic
- Limited launderability, or hand wash up to 50 launderings



FGD45306

NO.	COLOR	DESCRIPTION	U.S. HEADBAND SIZE	U.S. SHIP WT/CTN	MOP SIZE	METRIC HEADBAND SIZE	METRIC SHIP WT/CTN	HEADBAND COLOR	PACK
FGD41206	WH00	Super Stitch® Rayon Mop	1"	5.9 lb	Medium	2.5 cm	2.7 kg	GRN	6
FGD41306	WH00	Super Stitch® Rayon Mop	1"	8.0 lb	Large	2.5 cm	3.6 kg	RED	6
FGD45306	WH00	Super Stitch® Rayon Mop	5"	8.0 lb	Large	12.7 cm	3.6 kg	RED	6

Super Stitch® Cotton Scrubbing Wet Mops

The Scrubbing Wet Mop features an integrated scrubbing headband that removes stuck-on messes faster without interrupting the mopping process.

- Integrated scrubbing headband removes stuck-on debris 2x faster than a traditional Rubbermaid Commercial Products wet mop.
- Universal scrubbing headband is compatible with side-loading Invader® and clamp-style Gripper® handles.
- Double-sided and securely sewn-in scrubbing headband lasts the lifetime of the mop.
- Designed for effective scrubbing without scratching on a variety of floor types, including laminate, linoleum, vinyl, and light and dark hardwood



NO.	COLOR	DESCRIPTION	U.S. HEADBAND SIZE	U.S. SHIP WT/CTN	MOP SIZE	METRIC HEADBAND SIZE	METRIC SHIP WT/CTN	HEADBAND COLOR	PACK
2036121	White	Super Stitch® Cotton Scrubbing Wet Mop	Universal	8.07 lb	Large	Universal	3.66 kg	Green	6
2036123	White	Super Stitch® Cotton Scrubbing Wet Mop	Universal	6.75 lb	Medium	Universal	3.06 kg	Green	6
2036100	White	Super Stitch® Cotton Scrubbing Wet Mop	Universal	5.25 lb	Small	Universal	2.38 kg	Green	6
FGD45306	WH00	Super Stitch® Rayon Mop	5"	8.0 lb	Large	12.7 cm	3.6 kg	Red	6

UTILITY REFUSE AND RECYCLING

DECORATIVE REFUSE

CLEANING

MATERIAL HANDLING

WASHROOM

FOODSERVICE

ACCESSORIES & INDEX



Super Stitch® Cotton Mop

Economical, general-purpose mop.

- Looped-end 4-ply yarn with yarn tailband for greater coverage with each stroke
- Recycled content: up to 100% post-industrial cotton
- **Shipped as compact mop packages**
- Limited launderability, or hand wash up to 50 launderings



NO.	COLOR	DESCRIPTION	U.S. HEADBAND SIZE	U.S. SHIP WT/CTN	MOP SIZE	METRIC HEADBAND SIZE	METRIC SHIP WT/CTN	HEADBAND COLOR	PACK
FGD11306	WH00	Super Stitch® Cotton Looped-End Wet Mop	1"	7.6 lb	Large	2.5 cm	3.4 kg	RED	6

Super Stitch® Finish Mops

Blend yarns for great absorbency and release.

- Bright blue and white yarn helps identify finish mop versus general-purpose mop
- Looped ends and yarn tailband help reduce streaking
- Tightly twisted, 4-ply polyester and rayon yarn helps reduce linting
- Recycled content: 74% PET plastic
- **Shipped as compact mop packages**
- Limited launderability, or hand wash up to 50 launderings



FGD55306

NO.	COLOR	DESCRIPTION	U.S. HEADBAND SIZE	U.S. SHIP WT/CTN	MOP SIZE	METRIC HEADBAND SIZE	METRIC SHIP WT/CTN	HEADBAND COLOR	PACK
FGD51206	WH00	Super Stitch® Finish Mop	1"	5.9 lb	Medium	2.5 cm	2.7 kg	BLUE	6
FGD51306	WH00	Super Stitch® Finish Mop	1"	5.9 lb	Large	2.5 cm	2.7 kg	BLUE	6
FGD55206	WH00	Super Stitch® Finish Mop	5"	5.9 lb	Medium	12.7 cm	3.6 kg	BLUE	6
FGD55306	WH00	Super Stitch® Finish Mop	5"	8.0 lb	Large	12.7 cm	3.6 kg	BLUE	6

Super Stitch® Blend Scrubbing Wet Mops

The Scrubbing Wet Mop features an integrated scrubbing headband that removes stuck-on messes faster without interrupting the mopping process.

- Integrated scrubbing headband removes stuck-on debris 2x faster than a traditional Rubbermaid Commercial Products wet mop.
- Universal scrubbing headband is compatible with side-loading Invader® and clamp-style Gripper® handles.
- Double-sided and securely sewn-in scrubbing headband lasts the lifetime of the mop.
- Designed for effective scrubbing without scratching on a variety of floor types, including laminate, linoleum, vinyl, and light and dark hardwood.



NO.	COLOR	DESCRIPTION	U.S. HEADBAND SIZE	U.S. SHIP WT/CTN	MOP SIZE	METRIC HEADBAND SIZE	METRIC SHIP WT/CTN	HEADBAND COLOR	PACK
2036096	Blue	Super Stitch® Blend Scrubbing Wet Mop	Universal	8.07 lb	Large	Universal	3.66 kg	Green	6
2036099	Green	Super Stitch® Blend Scrubbing Wet Mop	Universal	8.07 lb	Large	Universal	3.66 kg	Green	6
2036129	Red	Super Stitch® Blend Scrubbing Wet Mop	Universal	8.07 lb	Large	Universal	3.66 kg	Green	6
2036125	White	Super Stitch® Blend Scrubbing Wet Mop	Universal	8.07 lb	Large	Universal	3.66 kg	Green	6
2036127	Blue	Super Stitch® Blend Scrubbing Wet Mop	Universal	6.75 lb	Medium	Universal	3.06 kg	Green	6
2036124	Green	Super Stitch® Blend Scrubbing Wet Mop	Universal	6.75 lb	Medium	Universal	3.06 kg	Green	6
2036122	Red	Super Stitch® Blend Scrubbing Wet Mop	Universal	6.75 lb	Medium	Universal	3.06 kg	Green	6
2036128	White	Super Stitch® Blend Scrubbing Wet Mop	Universal	6.75 lb	Medium	Universal	3.06 kg	Green	6
2036098	Blue	Super Stitch® Blend Scrubbing Wet Mop	Universal	5.25 lb	Small	Universal	2.38 kg	Green	6
2036126	Green	Super Stitch® Blend Scrubbing Wet Mop	Universal	5.25 lb	Small	Universal	2.38 kg	Green	6
2036130	White	Super Stitch® Blend Scrubbing Wet Mop	Universal	5.25 lb	Small	Universal	2.38 kg	Green	6
2036097	White	Super Stitch® Blend Scrubbing Wet Mop	Universal	10.90 lb	X-Large	Universal	4.94 kg	Green	6

UTILITY REFUSE AND RECYCLING

DECORATIVE REFUSE

CLEANING

MATERIAL HANDLING

WASHROOM

FOODSERVICE

ACCESSORIES & INDEX

Super Stitch® Blend Mops

Outperforms and outlasts premium cut-end mops 2 to 1.

- Balanced blend of cotton and synthetic yarns for absorbency and strength
- Looped ends and yarn tailband provide greater floor coverage
- Recycled content: colors are up to 65% post-industrial cotton and 35% PET plastic
- Shipped as compact mop packages
- Limited launderability, or hand wash up to 50 launderings



FGD25206



NO.	COLOR	DESCRIPTION	U.S. HEADBAND SIZE	U.S. SHIP WT/CTN	MOP SIZE	METRIC HEADBAND SIZE	METRIC SHIP WT/CTN	HEADBAND COLOR	PACK
FGD21106	WH00, BL00	Super Stitch® Blend Mop	1"	4.0 lb	Small	2.5 cm	1.8 kg	YEL	6
FGD21206	GR00*, RD00, WH00, BL00	Super Stitch® Blend Mop	1"	5.9 lb	Medium	2.5 cm	2.7 kg	GRN	6
FGD21306	GR00, RD00, WH00*, BL00	Super Stitch® Blend Mop	1"	8.0 lb	Large	2.5 cm	3.6 kg	RED	6
FGD21406	WH00	Super Stitch® Blend Mop	1"	10.7 lb	X-Large	2.5 cm	4.9 kg	BLUE	6
FGD25106	WH00, BL00	Super Stitch® Blend Mop	5"	4.0 lb	Small	12.7 cm	1.8 kg	YEL	6
FGD25206	GR00, RD00, WH00, BL00	Super Stitch® Blend Mop	5"	5.9 lb	Medium	12.7 cm	2.7 kg	GRN	6
FGD25306	GR00, RD00, WH00, BL00	Super Stitch® Blend Mop	5"	8.0 lb	Large	12.7 cm	3.6 kg	RED	6
FGD25406	WH00	Super Stitch® Blend Mop	5"	11.5 lb	X-Large	12.7 cm	5.2 kg	BLUE	6

*Available in Bolt-On Headband 12-pack.

Universal Headband Blue Blend Mops

Cotton/synthetic yarn blend has almost twice the absorbency of cotton.

- Looped ends reduce fraying associated with cut-end mops
- Universal headband fits both side-loading and clamp-style handles
- Recycled content: up to 65% post-industrial cotton and 35% PET plastic
- Limited launderability, or hand wash up to 50 launderings



FGE23900



NO.	COLOR	DESCRIPTION	U.S. HEADBAND SIZE	U.S. SHIP WT/CTN	MOP SIZE	METRIC HEADBAND SIZE	METRIC SHIP WT/CTN	HEADBAND COLOR	PACK
FGE23600	BL00	Universal Headband Blue Blend Mop	Universal	13.0 lb	16 oz	0.5 kg	5.9 kg	BLUE	12
FGE23800	BL00	Universal Headband Blue Blend Mop	Universal	19.0 lb	24 oz	0.7 kg	8.6 kg	BLUE	12
FGE23900	BL00	Universal Headband Blue Blend Mop	Universal	25.0 lb	32 oz	0.9 kg	11.3 kg	BLUE	12

Universal Headband Rayon Mops

Ideal for floor finish application.

- Looped ends reduce linting and depling
- Universal headband fits both side-loading and clamp-style handles
- Recycled content: up to 75%
- Limited launderability, or hand wash up to 50 launderings



FGE43800



NO.	COLOR	DESCRIPTION	U.S. HEADBAND SIZE	U.S. SHIP WT/CTN	MOP SIZE	METRIC HEADBAND SIZE	METRIC SHIP WT/CTN	HEADBAND COLOR	PACK
FGE43600	WH00	Universal Headband Rayon Mop	Universal	13.0 lb	16 oz	0.5 kg	5.9 kg	BLUE	12
FGE43800	WH00	Universal Headband Rayon Mop	Universal	19.0 lb	24 oz	0.7 kg	8.6 kg	BLUE	12

UTILITY REFUSE AND RECYCLING

DECORATIVE REFUSE

CLEANING

MATERIAL HANDLING

WASHROOM

FOODSERVICE

ACCESSORIES & INDEX



Universal Headband Cotton Mops

Excellent, all-purpose mop for general cleaning.

- Looped ends reduce fraying associated with cut-end mops
- Universal headband fits both side-loading and clamp-style handles
- Recycled content: up to 100% post-industrial cotton
- Limited launderability, or hand wash up to 50 launderings



FGE13900

NO.	COLOR	DESCRIPTION	U.S. HEADBAND SIZE	U.S. SHIP WT/ CTN	MOP SIZE	METRIC HEADBAND SIZE	METRIC SHIP WT/CTN	HEADBAND COLOR	PACK
FGE13600	WH00	Universal Headband Cotton Mop	Universal	12.0 lb	16 oz	0.5 kg	5.4 kg	BLUE	12
FGE13800	WH00	Universal Headband Cotton Mop	Universal	18.0 lb	24 oz	0.7 kg	8.2 kg	BLUE	12
FGE13900	WH00	Universal Headband Cotton Mop	Universal	24.0 lb	32 oz	0.9 kg	10.9 kg	BLUE	12

Dura Pro Blend Mops

Cut-end, 4-ply cotton/rayon/synthetic yarn blend for good performance and durability.

- Outlasts and outperforms cotton
- Excellent absorbency
- Narrow and wide headbands available (1" and 5")
- Recycled content: colors are up to 65% post-industrial cotton and 35% PET plastic
- Nonlaunderable, bucket wash/wring only



FGF55800

NO.	COLOR	DESCRIPTION	U.S. HEADBAND SIZE	U.S. SHIP WT/ CTN	U.S. MOP SIZE	METRIC HEADBAND SIZE	METRIC SHIP WT/CTN	METRIC MOP SIZE	HEADBAND COLOR	PACK
FGF51600	BLOO	Premium Cut-End Blend Mop	1"	13.0 lb	16 oz	2.5 cm	5.9 kg	0.5 kg	ORAN	12
FGF51700	WH00, BLOO	Premium Cut-End Blend Mop	1"	16.0 lb	20 oz	2.5 cm	7.3 kg	0.6 kg	ORAN	12
FGF51800	WH00, BLOO	Premium Cut-End Blend Mop	1"	19.0 lb	24 oz	2.5 cm	8.6 kg	0.7 kg	ORAN	12
FGF51900	BLOO	Premium Cut-End Blend Mop	1"	25.0 lb	32 oz	2.5 cm	11.3 kg	0.9 kg	ORAN	12
FGF55600	BLOO	Premium Cut-End Blend Mop	5"	13.0 lb	16 oz	12.7 cm	5.9 kg	0.5 kg	BLUE	12
FGF55700	BLOO	Premium Cut-End Blend Mop	5"	16.0 lb	20 oz	12.7 cm	7.3 kg	0.6 kg	BLUE	12
FGF55800	BLOO	Premium Cut-End Blend Mop	5"	19.0 lb	24 oz	12.7 cm	8.6 kg	0.7 kg	BLUE	12

Dura Pro Rayon Mops

Economical, 4-ply cut-end mop for floor finish applications.

- Excellent absorbency and release characteristics
- For economical floor finish applications
- Recycled content: up to 75%
- Nonlaunderable, bucket wash/wring only



FGF41800

NO.	COLOR	DESCRIPTION	U.S. HEADBAND SIZE	U.S. SHIP WT/ CTN	U.S. MOP SIZE	METRIC HEADBAND SIZE	METRIC SHIP WT/CTN	METRIC MOP SIZE	HEADBAND COLOR	PACK
FGF41600	WH00	Premium Cut-End Rayon Mop	1"	13.0 lb	16 oz	2.5 cm	5.9 kg	0.5 kg	ORAN	12
FGF41700	WH00	Premium Cut-End Rayon Mop	1"	16.0 lb	20 oz	2.5 cm	7.3 kg	0.6 kg	ORAN	12
FGF41800	WH00	Premium Cut-End Rayon Mop	1"	19.0 lb	24 oz	2.5 cm	8.6 kg	0.7 kg	ORAN	12
FGF41900	WH00	Premium Cut-End Blend Mop	1"	24.0 lb		2.5 cm	11.3 kg		ORAN	6
FGF55900	BLOO	Premium Cut-End Blend Mop	5"	24.0 lb		12.7 cm	11.3 kg		BLUE	6

UTILITY REFUSE AND RECYCLING

DECORATIVE REFUSE

CLEANING

MATERIAL HANDLING

WASHROOM

FOODSERVICE

ACCESSORIES & INDEX

Disposable Wet Mops

The new Disposable Mop from Rubbermaid Commercial Products helps workers reduce the spread of dirt and grime, resulting in cleaner floors. Engineered with hydrophilic, non-woven material, the RCP Disposable Mop is designed for one-time use to deliver a consistent clean shift after shift.

- Removes 3X More Dirt and Grease* (*Versus RCP economy cotton mops)
- No Break-In Period for Immediate Peak Performance
- Reduced Quat Binding* (*Versus used RCP economy cotton mops after 8-hour Quat exposure)
- Reduced linting* (*Versus RCP economy cotton mops)
- Product Made From 99% Recycled Material
- Tailband for Maximum Spread and Consistent Floor Coverage
- Safe for Floor Stripping



NO.	COLOR	DESCRIPTION	U.S. HEADBAND SIZE	U.S. SHIP WT/CTN	U.S. MOP SIZE	METRIC HEADBAND SIZE	METRIC SHIP WT/CTN	HEADBAND COLOR	PACK
2025501	White	Disposable Wet Mop	1"	7.30 lb	#16	2.5 cm	3.32 kg	White	24
2025502	White	Disposable Wet Mop	1"	8.65 lb	#20	2.5 cm	3.92 kg	White	24
2025503	White	Disposable Wet Mop	1"	10.25 lb	#24	2.5 cm	4.65 kg	White	24
2025504	White	Disposable Wet Mop	1"	11.65 lb	#32	2.5 cm	5.28 kg	White	24
2025505	White	Disposable Wet Mop	5"	7.40 lb	#16	12.7 cm	3.36 kg	WHITE	24
2025506	White	Disposable Wet Mop	5"	8.95 lb	#20	12.7 cm	4.06 kg	WHITE	24
2025507	White	Disposable Wet Mop	5"	10.55 lb	#24	12.7 cm	4.79 kg	WHITE	24
2025508	White	Disposable Wet Mop	5"	11.90 lb	#32	12.7 cm	5.40 kg	WHITE	24

Dura Pro Cotton Mops

Economical, 4-ply cut-end mop for general-purpose cleaning.

- Absorbent 4-ply cotton for general-purpose mopping
- Narrow and wide headbands available (1" and 5")
- Recycled content: up to 100% post-industrial cotton
- Shipped as compact mop packages
- Nonlaunderable, bucket wash/wring only



FGF15800

NO.	COLOR	DESCRIPTION	U.S. HEADBAND SIZE	U.S. SHIP WT/CTN	U.S. MOP SIZE	METRIC HEADBAND SIZE	METRIC SHIP WT/CTN	METRIC MOP SIZE	HEADBAND COLOR	PACK
FGF11600	WH00	Premium Cut-End Cotton Mop	1"	12.0 lb	16 oz	2.5 cm	5.4 kg	0.5 kg	ORAN	12
FGF11700	WH00	Premium Cut-End Cotton Mop	1"	15.0 lb	20 oz	2.5 cm	6.8 kg	0.6 kg	ORAN	12
FGF11800	WH00	Premium Cut-End Cotton Mop	1"	18.0 lb	24 oz	2.5 cm	8.2 kg	0.7 kg	ORAN	12
FGF11900	WH00	Premium Cut-End Cotton Mop	1"	24.0 lb	32 oz	2.5 cm	10.9 kg	0.9 kg	ORAN	12
FGF15600	WH00	Premium Cut-End Cotton Mop	5"	12.0 lb	16 oz	12.7 cm	5.4 kg	0.5 kg	BLUE	12
FGF15700	WH00	Premium Cut-End Cotton Mop	5"	15.0 lb	20 oz	12.7 cm	6.8 kg	0.6 kg	BLUE	12
FGF15800	WH00	Premium Cut-End Cotton Mop	5"	18.0 lb	24 oz	12.7 cm	8.2 kg	0.7 kg	BLUE	12
FGF15900	WH00	Premium Cut-End Cotton Mop	5"	24.0 lb	32 oz	12.7 cm	10.9 kg	0.9 kg	BLUE	12



Value Pro Cut-End Cotton and Rayon Wet Mops

Cotton mop for general, all-purpose cleaning; rayon mop for finish application

- Available in narrow and wide headbands (1" and 5")
- Recycled content: up to 100% post-industrial cotton
- Actual weight may vary by 2 oz.
- Shipped as compact mop packages
- Nonlaunderable, bucket wash/wring only



FGV15700

Value Pro Cotton Mops

NO.	COLOR	DESCRIPTION	U.S. HEADBAND SIZE	U.S. SHIP WT/ CTN	U.S. MOP SIZE	METRIC HEADBAND SIZE	METRIC SHIP WT/ CTN	METRIC MOP SIZE	HEADBAND COLOR	PACK
FGV11600	WH00	Economy Cotton Cut-End Mop	1"	10.1 lb	#16	2.5 cm	4.6 kg	N/A	WHT	12
FGV11700	WH00	Economy Cotton Cut-End Mop	1"	13.1 lb	#20	2.5 cm	5.9 kg	N/A	WHT	12
FGV11800	WH00	Economy Cotton Cut-End Mop	1"	15.8 lb	#24	2.5 cm	7.2 kg	N/A	WHT	12
FGV11900	WH00	Economy Cotton Cut-End Mop	1"	21.0 lb	#32	2.5 cm	9.5 kg	N/A	WHT	12
FGV15600	WH00	Economy Cotton Cut-End Mop	5"	10.2 lb	#16	12.7 cm	4.6 kg	N/A	WHT	12
FGV15700	WH00	Economy Cotton Cut-End Mop	5"	13.1 lb	#20	12.7 cm	5.9 kg	N/A	WHT	12
FGV15800	WH00	Economy Cotton Cut-End Mop	5"	15.8 lb	#24	12.7 cm	7.2 kg	N/A	WHT	12
FGV15900	WH00	Economy Cotton Cut-End Mop	5"	21.0 lb	#32	12.7 cm	9.5 kg	N/A	WHT	12

Value Pro Rayon Mops

NO.	COLOR	DESCRIPTION	U.S. HEADBAND SIZE	U.S. SHIP WT/ CTN	U.S. MOP SIZE	METRIC HEADBAND SIZE	METRIC SHIP WT/ CTN	METRIC MOP SIZE	HEADBAND COLOR	PACK
FGV41600	WH00	Economy Rayon Cut-End Mop	1"	12.0 lb	#16	2.5 cm	5.4 kg	N/A	WHT	12
FGV41700	WH00	Economy Rayon Cut-End Mop	1"	15.0 lb	#20	2.5 cm	6.8 kg	N/A	WHT	12
FGV41800	WH00	Economy Rayon Cut-End Mop	1"	18.0 lb	#24	2.5 cm	8.2 kg	N/A	WHT	12
FGV41900	WH00	Economy Rayon Cut-End Mop	1"	23.0 lb	#32	2.5 cm	10.4 kg	N/A	WHT	12

Bolt-On Cut-End Blend Mops

Cut-end mop with screw-on head for general-purpose mopping.

- Blend of 4-ply cotton/rayon/synthetic
- Enhanced mop-to-floor contact
- Recycled content: colors are up to 65% post-industrial cotton and 35% PET plastic
- Nonlaunderable, bucket wash/wring only



FGF56800

NO.	COLOR	DESCRIPTION	U.S. HEADBAND SIZE	U.S. SHIP WT/ CTN	U.S. MOP SIZE	METRIC HEADBAND SIZE	METRIC SHIP WT/ CTN	METRIC MOP SIZE	HEADBAND COLOR	PACK
FGF56600	BL00	Premium Bolt-On Cut-End Blend Mop	N/A	13.0 lb	16 oz	N/A	5.9 kg	0.5 kg	N/A	12
FGF56700	BL00	Premium Bolt-On Cut-End Blend Mop	N/A	16.0 lb	20 oz	N/A	7.3 kg	0.6 kg	N/A	12
FGF56800	BL00	Premium Bolt-On Cut-End Blend Mop	N/A	19.0 lb	24 oz	N/A	8.6 kg	0.7 kg	N/A	12

Bolt-On Cut-End Rayon Mops

Cut-end mop for finish applications.

- Cut-end, 4-ply rayon yarn
- Enhanced mop-to-floor contact
- Recycled content: up to 75%
- Nonlaunderable, bucket wash/wring only



FGF46800

NO.	COLOR	DESCRIPTION	U.S. HEADBAND SIZE	U.S. SHIP WT/ CTN	U.S. MOP SIZE	METRIC HEADBAND SIZE	METRIC SHIP WT/ CTN	METRIC MOP SIZE	HEADBAND COLOR	PACK
FGF46700	WH00	Premium Bolt-On Cut-End Rayon Mop	N/A	16.0 lb	20 oz	N/A	7.3 kg	0.6 kg	N/A	12
FGF46800	WH00	Premium Bolt-On Cut-End Rayon Mop	N/A	19.0 lb	24 oz	N/A	8.6 kg	0.7 kg	N/A	12

UTILITY REFUSE AND RECYCLING

DECORATIVE REFUSE

CLEANING

MATERIAL HANDLING

WASHROOM

FOODSERVICE

ACCESSORIES & INDEX

Bolt-On Cut-End Cotton Mops

Cut-end mop with screw-on head for general-purpose mopping.

- Absorbent 4-ply cotton yarn
- Enhanced mop-to-floor contact
- Recycled content: up to 100% post-industrial cotton
- Nonlaunderable, bucket wash/wring only



FGF16800

NO.	COLOR	DESCRIPTION	U.S. HEADBAND SIZE	U.S. SHIP WT/CTN	U.S. MOP SIZE	METRIC HEADBAND SIZE	METRIC SHIP WT/CTN	METRIC MOP SIZE	HEADBAND COLOR	PACK
FGF16600	WH00	Premium Bolt-On Cut-End Cotton Mop	N/A	13.0 lb	16 oz	N/A	5.9 kg	0.5 kg	N/A	12
FGF16700	WH00	Premium Bolt-On Cut-End Cotton Mop	N/A	16.0 lb	20 oz	N/A	7.3 kg	0.6 kg	N/A	12
FGF16800	WH00	Premium Bolt-On Cut-End Cotton Mop	N/A	19.0 lb	24 oz	N/A	8.6 kg	0.7 kg	N/A	12

8-Ply Cut-End Cotton Mops

Economical, 8-ply cut-end mop for general-purpose cleaning.

- Abrasion-resistant, long-lasting 8-ply cotton
- Recycled content: up to 100% post-industrial cotton
- Nonlaunderable, bucket wash/wring



FGF21800

NO.	COLOR	DESCRIPTION	U.S. HEADBAND SIZE	U.S. SHIP WT/CTN	U.S. MOP SIZE	METRIC HEADBAND SIZE	METRIC SHIP WT/CTN	METRIC MOP SIZE	HEADBAND COLOR	PACK
FGF21600	WH00	Premium 8-Ply Cut-End Cotton Mop	1"	13.0 lb	16 oz	2.5 cm	5.9 kg	0.5 kg	ORAN	12
FGF21700	WH00	Premium 8-Ply Cut-End Cotton Mop	1"	16.0 lb	20 oz	2.5 cm	7.3 kg	0.6 kg	ORAN	12
FGF21800	WH00	Premium 8-Ply Cut-End Cotton Mop	1"	19.0 lb	24 oz	2.5 cm	8.6 kg	0.7 kg	ORAN	12
FGF21900	WH00	Premium 8-Ply Cut-End Cotton Mop	1"	25.0 lb	32 oz	2.5 cm	11.3 kg	0.9 kg	ORAN	12

Synthetic Blend Mops

Economical, cut-end wet mop for general cleaning.

- All-synthetic mop yarn resists abrasive floor surfaces, such as quarry tile, for long-lasting performance
- Yarn blend absorbs 4 to 5 times the mop's weight
- Colors are perfect for a color-coding system and resist mop graying for long-lasting, like-new appearance
- Available in compact packages
- Recycled content: up to 70% post-consumer PET plastic
- Nonlaunderable, bucket wash/wring only



FGF13100

NO.	COLOR	DESCRIPTION	U.S. HEADBAND SIZE	U.S. SHIP WT/CTN	U.S. MOP SIZE	METRIC HEADBAND SIZE	METRIC SHIP WT/CTN	METRIC MOP SIZE	HEADBAND COLOR	PACK
FGF13100	PINK, GR00, BL00	Synthetic Blend Mop	1"	6.0 lb	16 oz	2.5 cm	2.7 kg	0.5 kg	WHT	6
FGF13200	GR00, BL00	Synthetic Blend Mop	1"	8.6 lb	24 oz	2.5 cm	3.9 kg	0.7 kg	WHT	6
FGF13600	GR00, BL00	Synthetic Blend Mop	5"	6.0 lb	16 oz	12.7 cm	2.7 kg	0.5 kg	WHT	6
FGF13700	PINK, GR00, BL00	Synthetic Blend Mop	5"	8.6 lb	24 oz	12.7 cm	3.9 kg	0.7 kg	WHT	6

UTILITY REFUSE AND RECYCLING

DECORATIVE REFUSE

CLEANING

MATERIAL HANDLING

WASHROOM

FOODSERVICE

ACCESSORIES & INDEX



Clean Room Maintenance Mops

Looped-end, tailbanded mop for greater floor coverage with each stroke.

- For use in Class 10,000 and higher industrial applications, such as paint booths and pharmaceutical labs
- Made of woven, rayon/polyester fabric that will not fray or lint
- Launderable and preshrunk for long product life
- Premium launderability, up to 75 launderings



FGT30100

NO.	COLOR	DESCRIPTION	U.S. HEADBAND SIZE	U.S. SHIP WT/ CTN	U.S. MOP SIZE	METRIC HEADBAND SIZE	METRIC SHIP WT/ CTN	METRIC MOP SIZE	HEADBAND COLOR	PACK
FGT30000	WH00	Clean Room Mop	5"	13.0 lb	16 oz	2.7 cm	5.9 kg	0.5 kg	GRN	12
FGT30100	WH00	Clean Room Mop	5"	19.0 lb	24 oz	2.7 cm	8.6 kg	0.7 kg	RED	12

Rough-Floor Wet Mops

Economical choice for abrasive floor surfaces.

- Knitted fleece cotton/polyester blend yarn has twice the absorbency of cotton
- Excels on abrasive floor surfaces, such as nonslip/nonskid, stone, terrazzo, concrete, and other textured floor surfaces
- Looped ends and tailband aid in launderability
- Headband is compatible with Clamp-Style Wet Mop Handle
- Premium launderability, up to 75 launderings



FGT25600

NO.	COLOR	DESCRIPTION	U.S. HEADBAND SIZE	U.S. SHIP WT/ CTN	U.S. MOP SIZE	METRIC HEADBAND SIZE	METRIC SHIP WT/ CTN	METRIC MOP SIZE	HEADBAND COLOR	PACK
FGT25500	WH00	Rough-Floor Wet Mop	5"	12.0 lb	Medium	2.7 cm	5.4 kg	N/A	GRN	12
FGT25600	WH00	Rough-Floor Wet Mop	5"	15.0 lb	Large	2.7 cm	6.8 kg	N/A	RED	12

Nylon Finish Mops

Nonlinting, continuous-filament yarn leaves an even, glossy, long-lasting finish every time.

- Innovative looped-end yarn construction holds finish for an even, efficient release
- Mop glides effortlessly across floor surface
- Premium launderability, up to 75 launderings



FGT20106

NO.	COLOR	DESCRIPTION	U.S. HEADBAND SIZE	U.S. SHIP WT/ CTN	U.S. MOP SIZE	METRIC HEADBAND SIZE	METRIC SHIP WT/ CTN	METRIC MOP SIZE	HEADBAND COLOR	PACK
FGT20006	WH00	Nylon Finish Mop	1"	7.1 lb	Medium	2.5 cm	3.2 kg	Medium	N/A	6
FGT20106	WH00	Nylon Finish Mop	1"	9.9 lb	Large	2.5 cm	4.5 kg	Large	N/A	6

UTILITY REFUSE AND RECYCLING

DECORATIVE REFUSE

CLEANING

MATERIAL HANDLING

WASHROOM

FOODSERVICE

ACCESSORIES & INDEX

Wet Mop Handles

Invader® and Gripper® Wet Mop Handles make removing and replacing mop heads easy and efficient.

- Invader® Side-Gate Handle's thumbwheel clamps the mop firmly in place; should be used with 1" headband mops
- Gripper® Clamp-Style Handles hold mop firmly between the jaws of the mop handle; should be used with 5" headband mops only
- Hardwood, Aluminum, and Fiberglass for all applications

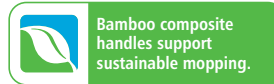

Invader® Side-Gate Handles



Invader® Side-Gate Style Wet Mop Handles

NO.	COLOR	DESCRIPTION	U.S. DIMENSIONS	U.S. SHIP WT/CTN	METRIC DIMENSIONS	METRIC SHIP WT/CTN	PACK
FGH11500	0000	Invader® Side-Gate Wet Mop Handle, Large Yellow Plastic Head, Hardwood Handle	54" l	13.0 lb	137.2 cm	5.9 kg	12
FGH11600	0000	Invader® Side-Gate Wet Mop Handle, Large Yellow Plastic Head, Hardwood Handle	60" l	15.0 lb	152.4 cm	6.8 kg	12
FGH12500	0000	Invader® Side-Gate Wet Mop Handle, Large Yellow Plastic Head, Gray Aluminum Handle	54" l	11.0 lb	137.2 cm	5 kg	12
FGH12600	0000	Invader® Side-Gate Wet Mop Handle, Large Yellow Plastic Head, Gray Aluminum Handle	60" l	12.0 lb	152.4 cm	5.4 kg	12
FGH13500	0000	Invader® Side-Gate Wet Mop Handle, Large Yellow Plastic Head, Vinyl-Covered Aluminum Handle	54" l	15.0 lb	137.2 cm	6.8 kg	12
FGH13600	0000	Invader® Side-Gate Wet Mop Handle, Large Yellow Plastic Head, Vinyl-Covered Aluminum Handle	60" l	17.0 lb	152.4 cm	7.7 kg	12
FGH14500	0000	Invader® Side-Gate Wet Mop Handle, Large Yellow Plastic Head, Fiberglass Handle	54" l	15.0 lb	137.2 cm	6.8 kg	12
FGH14600	GY00, GR00, RD00, BL00	Invader® Side-Gate Wet Mop Handle, Large Yellow Plastic Head, Fiberglass Handle	60" l	17.0 lb	152.4 cm	7.7 kg	12
1863903	BLACK	Executive 60" Fiberglass Mop Handle and Invader® Side-Gate Frame – String Mop	60" l	17.0 lb	152.4 cm	7.7 kg	12
FGH51600	0000	Easy-Change Wet Mop Handle, Large Steel Head, Wood Handle	60" l x 1 1/8" dia	31.0 lb	2.9 cm dia x 152.4 cm	14.1 kg	12



Gripper® Clamp-Style Handles



Gripper® Clamp-Style Wet Mop Handles

NO.	COLOR	DESCRIPTION	U.S. DIMENSIONS	U.S. SHIP WT/CTN	METRIC DIMENSIONS	METRIC SHIP WT/CTN	PACK
FGH21500	0000	Gripper® Clamp-Style Wet Mop Handle, Plastic Yellow Head, Hardwood Handle	54" l	13.0 lb	137.2 cm	5.9 kg	12
FGH21600	0000	Gripper® Clamp-Style Wet Mop Handle, Plastic Yellow Head, Hardwood Handle	60" l	15.0 lb	152.4 cm	6.8 kg	12
1863901	BLACK	Executive 60" Fiberglass Mop Handle and Gripper® Clamp Frame – String Mop	60" l	16.9 lb	152.4 cm	7.7 kg	12
FGH22500	0000	Gripper® Clamp-Style Wet Mop Handle, Plastic Yellow Head, Gray Aluminum Handle	54" l	11.0 lb	137.2 cm	5 kg	12
FGH22600	0000	Gripper® Clamp-Style Wet Mop Handle, Plastic Yellow Head, Gray Aluminum Handle	60" l	12.0 lb	152.4 cm	5.4 kg	12
FGH23600	0000	Gripper® Clamp-Style Wet Mop Handle, Plastic Yellow Head, Vinyl-Coated Aluminum Handle	60" l	17.0 lb	152.4 cm	7.7 kg	12
FGH24500	0000	Gripper® Clamp-Style Wet Mop Handle, Plastic Yellow Head, Fiberglass Handle	54" l	15.0 lb	137.2 cm	6.8 kg	12
FGH24600	GY00, GR00, RD00, BL00	Gripper® Clamp-Style Wet Mop Handle, Plastic Yellow Head, Fiberglass Handle	60" l	17.0 lb	152.4 cm	7.7 kg	12



Adjustable Mop Handles

Designed to help reduce the physical strain of mopping.

- Unique handle grip swivels radially a full 360° in either direction to help reduce wrist strain
- Corrosion-resistant aluminum handle adjusts from 54" to 66" for maximum reach
- User-friendly bent handle minimizes the force and leverage required for smooth mopping
- Available with a clamp-style head that accommodates a 5" headband mop or side-gate head that accommodates a 1" headband mop



FGH12400



NO.	COLOR	DESCRIPTION	U.S. DIMENSIONS	U.S. SHIP WT/CTN	METRIC DIMENSIONS	METRIC SHIP WT/CTN	PACK
FGH12400	0000	User-Friendly Mop Handle with Side-Gate Head	54"-66" l	11 lb	137.2 cm – 167.6 cm	5 kg	12

Laundry Net

Helps protect mops, microfiber pads, and other cleaning items during laundering.

- Locking closure keeps pads and cloths secure
- Provides easy organization for multiple cleaning crews



FGU21000

NO.	COLOR	DESCRIPTION	U.S. DIMENSIONS	U.S. SHIP WT/CTN	METRIC DIMENSIONS	METRIC SHIP WT/CTN	PACK
FGU21000	WH00	Laundry Net, Synthetic Mesh Bag with Locking Closure	36" l x 24" w	6 lb	91.4 cm x 61 cm	2.7 kg	12

BRUTE® Buckets

Heavy-duty thick-walled construction.

- BRUTE® buckets have molded-in graduations for accurate measuring
- Corrosion-resistant bails with comfortable plastic grip



FG261400



FG296300



1867341

NO.	COLOR	DESCRIPTION	U.S. DIMENSIONS	U.S. CAPACITY	U.S. SHIP WT/CTN	METRIC DIMENSIONS	METRIC CAPACITY	METRIC SHIP WT/CTN	PACK
FG261400	RED, GRAY	Round Bucket	12" dia x 11.25" h	14 qt	10.7 lb	30.5 cm dia x 28.6 cm	13.2L	4.9 kg	6
FG296300	RED, GRAY	Round Bucket	10.5" dia x 10.25" h	10 qt	14.3 lb	26.7 cm dia x 26 cm	9.5 L	6.5 kg	12
1834781	RED	Round Bucket – Sanitizer	10.5" dia x 10.25" h	10 qt	14.3 lb	26.7 cm dia x 26 cm	9.5 L	6.5 kg	12

Pail and Mop Strainer Combination

Lightweight design helps increase operator productivity.

- Lightweight combo pack lets operator travel up and down stairs easily
- Pail holds up to 15 quarts (14.2 L); strainer wrings mops up to 10 ounces
- Durable plastic construction has smooth, easy-to-clean surface
- Pails and funnel-shaped mop strainers nest and stack for convenient transport and storage between jobs



FG619400

NO.	COLOR	DESCRIPTION	U.S. DIMENSIONS	U.S. CAPACITY	U.S. SHIP WT/CTN	METRIC DIMENSIONS	METRIC CAPACITY	METRIC SHIP WT/CTN	PACK
FG619400	STL	Pail and Mop Strainer Combination	17" l x 10.5" w x 12" h	15 qt	14.9 lb	43.2 cm x 26.7 cm x 30.5 cm	14.2 L	6.8 kg	6
FGG04300	WH00	Replacement Mop Head for FGG04204	N/A	8 oz	7 lb	N/A	0.2 kg	3.2 kg	12
1809375	N/A	Self-Wringing Twist Mop	54" l x 54" w	N/A	17.5 lb	137.2 cm x 137.2 cm	N/A	7.9 kg	4

Steel Sponge Mop/Double Pails

An easy-to-use cleaning system.

- Front-pull lever on mop handle for squeeze-action wringing (FG643500)
- Cellulose sponge mop head absorbs liquids fast
- Double pail for separation of cleaning solution and rinse water



FG262888



FGG78004



FG643500

NO.	COLOR	DESCRIPTION	U.S. DIMENSIONS	U.S. CAPACITY	U.S. SHIP WT/CTN	METRIC DIMENSIONS	METRIC CAPACITY	METRIC SHIP WT/CTN	PACK
FG261700	GRAY	Double Pail	14.63" l x 13.88" w x 10.13" h	17 qt	18.1 lb	37.2 cm x 35.3 cm x 25.7 cm	16.1 L	8.2 kg	6
FG262888	GRAY	Double Pail	18" l x 14.5" w x 10" h	19 qt	21.1 lb	45.7 cm x 36.8 cm x 25.4 cm	18 L	9.6 kg	6
FG643500	BRNZ	Steel Sponge Mop with Cellulose Head	12" l	N/A	14.9 lb	30.5 cm	N/A	6.8 kg	6
FG643600	YEL	Steel Cellulose Replacement Head	12" l	N/A	8.4 lb	30.5 cm	N/A	3.8 kg	12
FGG78004		PVA Sponge Mop	11.3" l x 2.8" w x 37.6" h	N/A	35.0 lb	28.7 cm x 7.1 cm x 95.5 cm	N/A	15.9 kg	4
FGG78112		PVA Sponge Mop Refill	12.8" l x 4.2" w x 2.2" h	N/A	5.2 lb	32.5 cm x 10.7 cm x 5.6 cm	N/A	2.4 kg	12

UTILITY REFUSE AND RECYCLING

DECORATIVE REFUSE

CLEANING

MATERIAL HANDLING

WASHROOM

FOODSERVICE

ACCESSORIES & INDEX

Dust Mopping

There are several important factors to consider when choosing a dust mop. Use the guidelines on the following pages to choose the best dust mop for your floor care needs.

General Dust Mopping

Choose mops with high-dust pickup and durability. If laundering is available, launderable mops will be the most economical choice. Microfiber looped-end and twisted-loop mop heads with reinforced stitching and slip-on/slide-off backing offer the best performance and launderability.



Mop Construction Features



Twisted-Loops

Highly effective at capturing dust and dirt. Premium Twisted-Loops are less prone to snags, frays, and unraveling during cleaning and laundering.

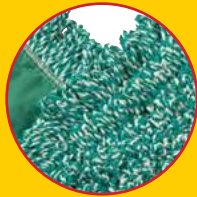

Looped Ends

Reduce fraying and depleting for better durability and longer product life. More effective than cut-end mops.



Cut Ends

Economical construction for general-purpose dusting.



Reinforced Stitching

Reinforced, double-needle stitching at key "wear" points increases product life.



Backing Design

Slip-on/slide-off backing allows quick, easy setup or breakdown for standard mop frames.

Launderability

The launderability of a mop is based on the number of commercial washing and drying cycles it can withstand before the construction of the mop is degraded or the performance declines. Microfiber, synthetic, and blended fiber mops have the highest levels of launderability.

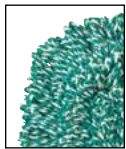

MICROFIBER



BLEND



SYNTHETIC

Durability

The durability of a mop is a measure of how long it will perform before needing to be replaced. Microfiber, synthetic, and blended fiber mops are the most durable.

Mops with **antimicrobial fibers** have greater durability because they inhibit the bacterial growth that causes mop odor and discoloration.

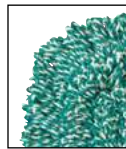

MICROFIBER



BLEND



ANTIMICROBIAL



SYNTHETIC

Dust Pickup

Dust pickup is the ability of a mop to remove dust and dirt from the floor surface. Microfiber, blended fiber, and synthetic mops have the highest degree of dust pickup.

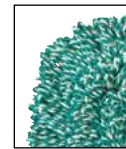

MICROFIBER



SYNTHETIC



BLEND

Dust Mop Selection Guide

Use the following guide to choose the best Rubbermaid Commercial Products Dust Mops for your facility.

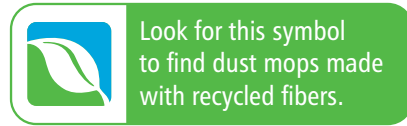

ENVIRONMENT	BEST	BETTER	GOOD
HEALTHCARE FACILITIES	HYGEN™ Microfiber Dust Mops Microfiber Looped-End Dust Mop Twisted-Loop Antimicrobial	Trapper®	Kut-A-Way®
EDUCATIONAL FACILITIES	HYGEN™ Microfiber Dust Mops Microfiber Looped-End Dust Mop Twisted-Loop	Kut-A-Way®	Cut-to-Length
INDUSTRIAL AND COMMERCIAL	HYGEN™ Microfiber Dust Mops Microfiber Looped-End Dust Mop Trapper®	Kut-A-Way®	Disposable Cut-End Blended
FOODSERVICE	HYGEN™ Microfiber Dust Mops Microfiber Looped-End Dust Mop Twisted-Loop	Kut-A-Way®	Disposable Cut-End Blended
OFFICE BUILDINGS	HYGEN™ Microfiber Dust Mops Microfiber Looped-End Dust Mop Twisted-Loop	Kut-A-Way®	Disposable Cut-End Blended
HOSPITALITY	HYGEN™ Microfiber Dust Mops Microfiber Looped-End Dust Mop Twisted-Loop	Kut-A-Way®	Disposable Cut-End Blended



UTILITY REFUSE
AND RECYCLING

DECORATIVE REFUSE

CLEANING

HYGEN™ Dust Mops

Capture and remove more dirt and dust.

HYGEN™ Dust Mops remove up to 80% more dust and dirt than traditional cotton dust mops. Durable up to 500 launderings (200 with bleach). Certified to tolerate CDC hot and cold water laundering requirements.

*see page 78 for more details

FGQ41800*
FGQ41200*

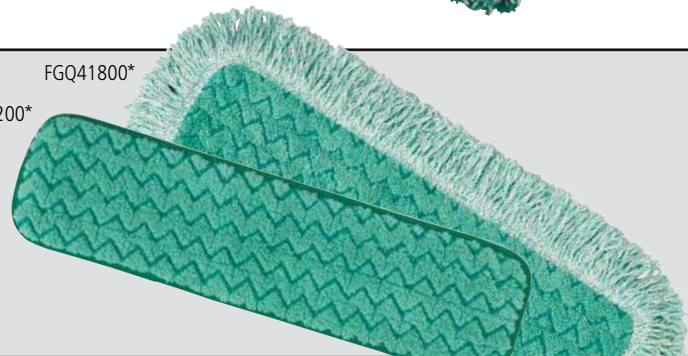

MATERIAL HANDLING

Microfiber Looped-End Dust Mops

Featuring the cleaning power of microfiber combined with famous high-quality Rubbermaid construction.

- Constructed with a blend of continuous-filament microfiber and traditional spun staple mop yarn
- Withstands twice the laundry cycles of traditional dust mops
- Works with all traditional dust mop handles and frames
- Recycled content: up to 28% post-industrial cotton and 42% PET plastic

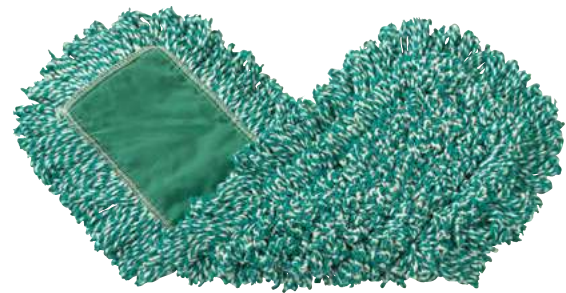

FGJ85300

WASHROOM

FOODSERVICE

NO.	MOP COLOR	DESCRIPTION	U.S. SHIP WT/CTN	U.S. MOP SIZE	METRIC SHIP WT/CTN	METRIC MOP SIZE	PACK
FGJ85200	GR00	Microfiber Loop Dust Mop 18"	9.25 lb	18" l x 5" w	4.2 kg	45.7 cm x 12.7 cm	12
FGJ85300	GR00	Microfiber Loop Dust Mop 24"	11.7 lb	24" l x 5" w	5.3 kg	61 cm x 12.7 cm	12
FGJ85500	GR00	Microfiber Loop Dust Mop 36"	15.0 lb	36" l x 5" w	6.8 kg	91.4 cm x 12.7 cm	12
FGJ85700	GR00	Microfiber Loop Dust Mop 48"	18.7 lb	48" l x 5" w	8.5 kg	121.9 cm x 12.7 cm	12
FGJ85800	GR00	Microfiber Loop Dust Mop 60"	22.4 lb	60" l x 5" w	10.2 kg	152.4 cm x 12.7 cm	12
FGJ85900	GR00	Microfiber Loop Dust Mop 72"	22.4 lb	72" l x 5" w	10.2 kg	182.9 cm x 12.7 cm	12

ACCESSORIES
& INDEX



Twisted-Loop Dust Mops

Premium prelaundered dust mops provide maximum durability and optimal cleaning performance. Twisted loops create fuller mop heads with no gaps, offering better coverage than traditional ply yarn and improved collection and retention of dust and dirt particles.

- Blended antimicrobial mops are specially treated to help inhibit the growth of bacteria
- Less prone to snagging, fraying, and unraveling
- Slip-on backing for easy setup
- Durable polyester backing designed for launderable printing that will not launder out
- *Handles sold separately; see Dust Mop Frames and Handles*



FGK75300 WH00 / FGJ25300 BL00 /
FGJ15300 YL00 / FGJ55300 GR00 /
FGJ35300 BL00



Blended Antimicrobial

NO.	COLOR	DESCRIPTION	U.S. SHIP WT/CTN	U.S. MOP SIZE	METRIC SHIP WT/CTN	METRIC MOP SIZE	PACK
FGJ55300	GR00	Twisted-Loop Blend Antimicrobial Dust Mop	12.4 lb	24" l x 5" w	5.6 kg	61 cm x 12.7 cm	12
FGJ55500	GR00	Twisted-Loop Blend Antimicrobial Dust Mop	17.7 lb	36" l x 5" w	8 kg	91.4 cm x 12.7 cm	12
FGJ55700	GR00	Twisted-Loop Blend Antimicrobial Dust Mop	22.4 lb	48" l x 5" w	10.2 kg	121.9 cm x 12.7 cm	12



Synthetic

NO.	COLOR	DESCRIPTION	U.S. SHIP WT/CTN	U.S. MOP SIZE	METRIC SHIP WT/CTN	METRIC MOP SIZE	PACK
FGJ35200	BL00	Twisted-Loop Synthetic Dust Mop	9.2 lb	18" l x 5" w	4.2 kg	45.7 cm x 12.7 cm	12
FGJ35300	BL00	Twisted-Loop Synthetic Dust Mop	12.4 lb	24" l x 5" w	5.6 kg	61 cm x 12.7 cm	12
FGJ35500	BL00	Twisted-Loop Synthetic Dust Mop	17.7 lb	36" l x 5" w	8 kg	91.4 cm x 12.7 cm	12
FGJ35700	BL00	Twisted-Loop Synthetic Dust Mop	22.4 lb	48" l x 5" w	10.2 kg	121.9 cm x 12.7 cm	12
FGJ35800	BL00	Twisted-Loop Synthetic Dust Mop	25.2 lb	60" l x 5" w	11.4 kg	152.4 cm x 12.7 cm	12



Blended

NO.	COLOR	DESCRIPTION	U.S. SHIP WT/CTN	U.S. MOP SIZE	METRIC SHIP WT/CTN	METRIC MOP SIZE	PACK
FGJ25200	BL00	Twisted-Loop Blend Dust Mop	9.2 lb	18" l x 5" w	4.2 kg	45.7 cm x 12.7 cm	12
FGJ25300	BL00	Twisted-Loop Blend Dust Mop	12.4 lb	24" l x 5" w	5.6 kg	61 cm x 12.7 cm	12
FGJ25500	BL00	Twisted-Loop Blend Dust Mop	17.7 lb	36" l x 5" w	8 kg	91.4 cm x 12.7 cm	12
FGJ25700	BL00	Twisted-Loop Blend Dust Mop	22.4 lb	48" l x 5" w	10.2 kg	121.9 cm x 12.7 cm	12



Cotton

NO.	COLOR	DESCRIPTION	U.S. SHIP WT/CTN	U.S. MOP SIZE	METRIC SHIP WT/CTN	METRIC MOP SIZE	PACK
FGK75300	WH00	Twisted-Loop Cotton Dust Mop	12.4 lb	24" l x 5" w	5.6 kg	61 cm x 12.7 cm	12
FGK75500	WH00	Twisted-Loop Cotton Dust Mop	17.7 lb	36" l x 5" w	8 kg	91.4 cm x 12.7 cm	12

UTILITY REFUSE AND RECYCLING

DECORATIVE REFUSE

CLEANING

MATERIAL HANDLING

WASHROOM

FOODSERVICE

ACCESSORIES & INDEX

Trapper® Dust Mops

Looped-end, balanced-blend dust mop for general-purpose dust mopping.

- Pretreated and fully launderable for long product life
- Slip-on backing for easy setup
- All-sewn construction
- Recycled content: up to 65% post-industrial cotton and 35% PET plastic



FGJ15700

NO.	COLOR	DESCRIPTION	U.S. SHIP WT/CTN	U.S. MOP SIZE	METRIC SHIP WT/CTN	METRIC MOP SIZE	PACK
FGJ15100	YL00	Trapper® Dust Mop	8.0 lb	12" l x 5" w	3.6 kg	30.5 cm x 12.7 cm	12
FGJ15200*	YL00	Trapper® Dust Mop	9.0 lb	18" l x 5" w	4.1 kg	45.7 cm x 12.7 cm	12
FGJ15300*	YL00	Trapper® Dust Mop	11.0 lb	24" l x 5" w	5.0 kg	61 cm x 12.7 cm	12
FGJ15500*	YL00	Trapper® Dust Mop	16.0 lb	36" l x 5" w	7.3 kg	91.4 cm x 12.7 cm	12
FGJ15700*	YL00	Trapper® Dust Mop	21.0 lb	48" l x 5" w	9.5 kg	121.9 cm x 12.7 cm	12
FGJ15800	YL00	Trapper® Dust Mop	25.2 lb	60" l x 5" w	11.4 kg	152.4 cm x 12.7 cm	12

*Available in 3-pack (-03).

Kut-A-Way® Dust Mops

Cut-end mop excellent for general-purpose dust mopping.

- Pre-laundered
- Launderable for long product life
- Envelope-end backing style
- All sewn construction
- Recycled content: colors are up to 65% post-industrial cotton and 35% PET plastic; white is up to 100% post-industrial cotton



FGK15700

NO.	COLOR	DESCRIPTION	U.S. SHIP WT/CTN	U.S. MOP SIZE	METRIC SHIP WT/CTN	METRIC MOP SIZE	PACK
FGK15200	WH00, BL00	Kut-A-Way® Dust Mop	9.0 lb	18" l x 5" w	4.1 kg	45.7 cm x 12.7 cm	12
FGK15300	WH00, BL00	Kut-A-Way® Dust Mop	11.0 lb	24" l x 5" w	5.0 kg	61 cm x 12.7 cm	12
FGK15500	WH00, BL00	Kut-A-Way® Dust Mop	16.0 lb	36" l x 5" w	7.3 kg	91.4 cm x 12.7 cm	12
FGK15700	WH00, BL00	Kut-A-Way® Dust Mop	21.0 lb	48" l x 5" w	9.5 kg	121.9 cm x 12.7 cm	12
FGK15800	WH00	Kut-A-Way® Dust Mop	26.0 lb	60" l x 5" w	11.8 kg	152.4 cm x 12.7 cm	12
FGK15900	WH00	Kut-A-Way® Dust Mop	31.0 lb	72" l x 5" w	14.1 kg	182.9 cm x 12.7 cm	12

Disposable Cut-End Blended Dust Mops

Soft, open-twist blended cut-end yarn for increased dust pickup.

- Pretreated and mops up to 500,000 sq ft (46,450 m²) before needing replacement
- Envelope-end backing style and durable Typar® backing
- Recycled content: colors are up to 65% post-industrial cotton and 35% PET plastic



FGL15700

NO.	COLOR	DESCRIPTION	U.S. SHIP WT/CTN	U.S. MOP SIZE	METRIC SHIP WT/CTN	METRIC MOP SIZE	PACK
FGL15300	GR00, WH00	Blended Cut-End Disposable Dust Mop	9.0 lb	24" l x 5" w	4.1 kg	61 cm x 12.7 cm	12
FGL15500	WH00	Blended Cut-End Disposable Dust Mop	13.0 lb	36" l x 5" w	5.9 kg	91.4 cm x 12.7 cm	12
FGL15700	GR00, WH00	Blended Cut-End Disposable Dust Mop	17.0 lb	48" l x 5" w	7.7 kg	121.9 cm x 12.7 cm	12
FGL15800	WH00	Blended Cut-End Disposable Dust Mop	21.0 lb	60" l x 5" w	9.5 kg	152.4 cm x 12.7 cm	12
FGL15900	WH00	Blended Cut-End Disposable Dust Mop	25.0 lb	72" l x 5" w	11.3 kg	182.9 cm x 12.7 cm	12

UTILITY REFUSE AND RECYCLING

DECORATIVE REFUSE

CLEANING

MATERIAL HANDLING

WASHROOM

FOODSERVICE

ACCESSORIES & INDEX

Disposable Cut-End Cotton Dust Mops

Economical cotton cut-end dust mop.

- Pretreated, with envelope-end backing style
- Recycled content: up to 100% post-industrial cotton



FGL25500

NO.	COLOR	DESCRIPTION	U.S. SHIP WT/CTN	U.S. MOP SIZE	METRIC SHIP WT/CTN	METRIC MOP SIZE	PACK
FGL25300	WH00	Cut-End Disposable Cotton Dust Mop	9.0 lb	24" l x 5" w	4.1 kg	61 cm x 12.7 cm	12
FGL25500	WH00	Cut-End Disposable Cotton Dust Mop	13.0 lb	36" l x 5" w	5.9 kg	91.4 cm x 12.7 cm	12
FGL25700	WH00	Cut-End Disposable Cotton Dust Mop	17.0 lb	48" l x 5" w	7.7 kg	121.9 cm x 12.7 cm	12

Snap-On Wire Dust Mop Frames

Corrosion-resistant, powder-coated, heavy-duty metal frame for durable performance.



FGM25100



NO.	COLOR	DESCRIPTION	U.S. DIMENSIONS	U.S. SHIP WT/CTN	METRIC DIMENSIONS	METRIC SHIP WT/CTN	PACK
FGM25100	0000	Snap-On Wire Dust Mop Frame	12" l x 5" w	9.0 lb	30.5 cm x 12.7 cm	4.1 kg	12
FGM25200	0000	Snap-On Wire Dust Mop Frame	18" l x 5" w	12.0 lb	45.7 cm x 12.7 cm	5.4 kg	12
FGM25300	0000	Snap-On Wire Dust Mop Frame	24" l x 5" w	14.0 lb	61 cm x 12.7 cm	6.4 kg	12
FGM25500	0000	Snap-On Wire Dust Mop Frame	36" l x 5" w	18.0 lb	91.4 cm x 12.7 cm	8.2 kg	12
FGM25700	0000	Snap-On Wire Dust Mop Frame	48" l x 5" w	22.0 lb	121.9 cm x 12.7 cm	10 kg	12
FGM25800	0000	Snap-On Wire Dust Mop Frame	60" l x 5" w	27.0 lb	152.4 cm x 12.7 cm	12.2 kg	12
FGM25900	0000	Snap-On Wire Dust Mop Frame	72" l x 5" w	33.0 lb	182.9 cm x 12.7 cm	15 kg	12

Snap-On Dust Mop Handles

Available in easily sanitized, vinyl-covered wood, fiberglass, or hardwood handles.

- Spring-loaded clip easily attaches to the Snap-On Dust Mop Frame
- Sliding collar locks the handle into position or swivels a full 360°

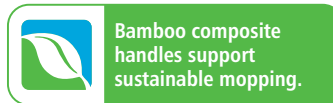

FGM11600

NO.	COLOR	DESCRIPTION	U.S. DIMENSIONS	U.S. SHIP WT/CTN	METRIC DIMENSIONS	METRIC SHIP WT/CTN	PACK
FGM11600	0000	Snap-On Dust Mop Handle, Hardwood	60" l	26.0 lb	152.4 cm	11.8 kg	12
FGM13600	0000	Snap-On Dust Mop Handle, Vinyl-Covered, Hardwood	60" l	26.0 lb	152.4 cm	11.8 kg	12
FGM14600	0000	Snap-On Dust Mop Handle, Fiberglass	60" l	24.0 lb	152.4 cm	10.9 kg	12

UTILITY REFUSE AND RECYCLING

DECORATIVE REFUSE

CLEANING

MATERIAL HANDLING

WASHROOM

FOODSERVICE

ACCESSORIES & INDEX

Cut-to-Length Dust Mop

Cuts floor cleaning costs down to size.

- Continuous 40' (12.2 m) roll yields 20% savings over conventional dust mops
- Cut-to-length convenience lets you customize your mop to fit any standard mop frame
- Untreated, cut-end 4-ply cotton yarn provides excellent dust pickup; durable Typar® backing for long life
- Slip-on backing for easy setup
- Recycled content: up to 100% post-industrial cotton



FGM15000



NO.	COLOR	DESCRIPTION	U.S. DIMENSIONS	U.S. CARTON DIMENSIONS	U.S. SHIP WT/CTN	METRIC DIMENSIONS	METRIC CARTON DIMENSIONS	METRIC SHIP WT/CTN	PACK
FGM15000	WH00	Cut-to-Length Dust Mop	40" l x 5" w	18 1/2" l x 11 3/4" w x 12 3/4" h	13.0 lb	101.6 cm x 12.7 cm	46.4 cm x 29.8 cm x 32.1 cm	5.9 kg	1

Wedge Mop System

For spot dust mopping in tight corners, under equipment, or behind furniture.

- Offered in Trapper® looped-end or Kut-A-Way® cut-end triangle-shaped wedge mops
- Wood handle with heavy-gauge plated wire frame fits either style head
- Envelope-end backing style
- U120 contains up to 35% PET plastic



FGU12000



FGU13000



FGU11000



NO.	COLOR	DESCRIPTION	U.S. SHIP WT/CTN	METRIC SHIP WT/CTN	PACK
FGU11000	0000	Wedge Mop Handle and Frame, Wood Handle with Metal Frame	17.0 lb	7.7 kg	12
FGU12000	YL00	Trapper® Wedge Mop Dust Mop Head, Looped-End	5.5 lb	2.5 kg	12
FGU13000	WH00	Kut-A-Way® Wedge Mop Dust Mop Head, Cut-End	5.5 lb	2.5 kg	12
FGU13067	WH00	Kut-A-Way® Wedge Mop Kit, Contains FGU13000 Mop, FGU11000 Handle, and Frame	3.0 lb	1.4 kg	1

UTILITY REFUSE AND RECYCLING

DECORATIVE REFUSE

CLEANING

MATERIAL HANDLING

WASHROOM

FOODSERVICE

ACCESSORIES & INDEX



MAXIMIZER™ Dust Mop with EZ Access Scraper

- EZ Access Scraper connects to handle for quick clean up of stuck-on debris
- Lightweight system weighs 30% less than standard RCP Dust Mop Frame & Handle
- Scraper features stainless steel blade for durability and superior wear resistance
- Quick change handle for easy tool attachment and molded grip for comfort



NO.	COLOR	DESCRIPTION	U.S. DIMENSIONS	U.S. SHIP WT/CTN	METRIC DIMENSIONS	METRIC SHIP WT/CTN	PACK
2018808	Black	Maximizer™ Dust Frame, Handle, and Scraper – 24"	57.0" l x 5.5" w x 1.8" h	1.9 lb	144.8 cm x 14.0 cm x 4.6 cm	4.8 kg	6
2018809	Black	Maximizer™ Dust Frame, Handle, and Scraper – 36"	57.0" l x 5.5" w x 1.8" h	2.6 lb	144.8 cm x 14.0 cm x 4.6 cm	6.6 kg	6
2018810	Yellow	Maximizer™ Dust Mop Pad – 24"	25.3" l x 5.5" w x 0.5" h	1.2 lb	64.3 cm x 14.0 cm x 1.3 cm	3.0 kg	12
2018821	Yellow	Maximizer™ Dust Mop Pad – 36"	37.3" l x 5.5" w x 0.5" h	1.7 lb	94.7 cm x 14.0 cm x 1.3 cm	4.3 kg	12
2018822	Black	Maximizer™ EZ Access Scraper – Replacement	6.6" l x 1.6" w x 1.6" h	0.2 lb	16.8 cm x 4.1 cm x 4.1 cm	0.5 kg	12

MAXIMIZER™ Overhead Cleaning Tool

- Cleans hard to reach spaces with less effort
- Multi-directional rotating head delivers better leverage when cleaning overhead surfaces
- Push button adjusts head to three different positions and locks in place for controlled cleaning in hard to reach areas
- Extends to 10' for maximum access to high surfaces
- Frame accepts 11" HYGEN™ Wall/Stair and 11" HYGEN™ Pads (sold separately)



2018825



2018824



NO.	COLOR	DESCRIPTION	U.S. DIMENSIONS	U.S. SHIP WT/CTN	METRIC DIMENSIONS	METRIC SHIP WT/CTN	PACK
2018824	Black	Maximizer™ Overhead Cleaning Tool	71.5" l x 3.5" w x 2.4" h	2.5 lb	181.6 cm x 8.9 cm x 6.1 cm	1.1 kg	6
2018825	Blue	11" HYGEN™ Microfiber Window Pad	12.6" l x 5.6" w x 0.2" h	0.1 lb	32.0 cm x 14.22 cm x 0.5 cm	0.04 kg	6

When ordering products with **BOLD** color codes, please specify color code after the product number. Refer to the Standard Color Guide at the back of the catalog.

UTILITY REFUSE AND RECYCLING

DECORATIVE REFUSE

CLEANING

MATERIAL HANDLING

WASHROOM

FOODSERVICE

ACCESSORIES & INDEX

Overhead Dusting Tools

A sensible solution to routine overhead dusting.

- Heads are launderable for long product life
- Telescoping handle allows simple and efficient overhead use
- The FGT13000 extends up to 102" (8½ feet/2.6 m) to reach high areas



FGT12000

Flexible-Head Overhead Dusting Tools

Flexible head adjusts to match surface.

- Flexible head conforms to virtually any shape for more efficient cleaning
- Launderable Dust Mitt can be worn on the hand or used with the Flexible Head Dusting Tool
- FGQ65200 Microfiber Dusting Mitt fits FGT41000 Dusting Tool



FGT41000

Lambswool Duster

Fast, effective surface dusting.

- 100% lambswool duster
- Ideal for dusting large areas quickly and effectively



FG9C0400

NO.	COLOR	DESCRIPTION	U.S. SHIP WT/CTN	METRIC SHIP WT/CTN	PACK
FGT11000	GY00	Overhead Dusting Tool with Launderable Head, 51" I (129.5 cm) Extension Handle	8.0 lb	3.6 kg	12
FGT12000	GY00	Overhead Dusting Tool with Angled Launderable Head, 51" I (129.5 cm) Extension Handle	8.0 lb	3.6 kg	12
FGT13000	GY00	Overhead Dusting Tool with Launderable Head, 8½' I (2.6 m) Extension Handle	17.0 lb	7.7 kg	12
FGT19900	WH00	Overhead Dusting Tool Replacement Head fits FGT11000, FGT12000, FGT13000	4.0 lb	1.8 kg	12
FGT41000	0000	Flexible-Head Overhead Dusting Tool, Flexible Head with 60" I (152.4 cm) Aluminum Handle	8.0 lb	3.6 kg	6
FG9C0400	0000	30"-42" (76.2 cm-106.6 cm) Lambswool Duster with Telescoping Plastic Handle	1.8 lb	0.8 kg	6

Carpet Bonnets

Use with a standard rotary floor machine for interim carpet maintenance.

- Standard thickness, original blend bonnets work well with either shampoo or solvent-based chemicals; use with a 175 RPM floor machine
- The low-profile bonnet provides improved operator control on rotary floor machines from 175 to 300 RPM



FGP26700



FGQ25700



FGQ11700

NO.	COLOR	DESCRIPTION	U.S. DIMENSIONS	U.S. SHIP WT/CTN	METRIC DIMENSIONS	METRIC SHIP WT/CTN	PACK
FGQ25700	WH00	17" Microfiber Carpet Bonnet	17" dia	8.0 lb	43.2 cm dia	3.6 kg	5
FGQ25900	WH00	19" Microfiber Carpet Bonnet	19" dia	9.0 lb	48.3 cm dia	4.1 kg	5
FGP11700	WH00	Standard Thickness Bonnet	17" dia	8.0 lb	43.2 cm dia	3.6 kg	5
FGP11900	WH00	Standard Thickness Bonnet	19" dia	9.0 lb	48.3 cm dia	4.1 kg	5
FGP12100	WH00	Standard Thickness Bonnet	21" dia	10.0 lb	53.3 cm dia	4.5 kg	5
FGP26700	WH00	Low-Profile with Green Scrub Strips Bonnet	17" dia	8.0 lb	43.2 cm dia	3.6 kg	5
FGP26900	WH00	Low-Profile with Green Scrub Strips Bonnet	19" dia	9.0 lb	48.3 cm dia	4.1 kg	5
FGP27100	WH00	Low-Profile with Green Scrub Strips Bonnet	21" dia	10.0 lb	53.3 cm dia	4.5 kg	5

BROOM CONSTRUCTION

Using a state of the art production process in Lumberton, NC, RCP push brooms feature advanced injection molding, computer-optimized bristle stapling and full-scale push broom assembly to ensure consistent, durable, high quality brooms that stand up to the most demanding commercial jobs.

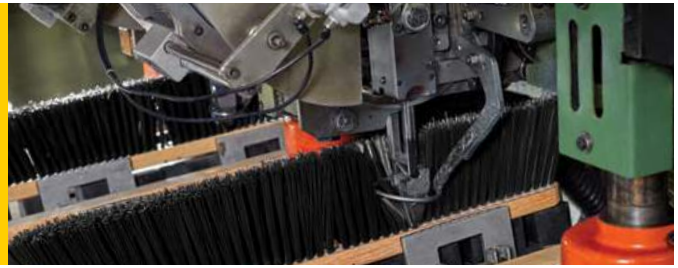

FINE BRISTLES (SMOOTH SURFACE)



POLYETHYLENE (PET)

Soft, durable material used to sweep fine debris on smooth surfaces.



TAMPICO

Soft, durable fiber with high resistance to heat and chemicals, used to sweep fine debris on wet or dry smooth surfaces.



HORSEHAIR

Premium ultra-smooth natural fiber used to sweep fine debris on smooth surfaces.

MEDIUM BRISTLES (MULTI-SURFACE)



MEDIUM POLYPROPYLENE

Medium-weight, durable fiber made to sweep debris on medium to rough surfaces.



MULTI-SURFACE

Medium-weight stiff inner polypropylene fibers and soft outer polyethylene fibers designed to sweep debris on indoor or outdoor surfaces.

HEAVY DUTY BRISTLES (ROUGH SURFACE)



PALMYRA

Rugged, natural fiber for medium to heavy debris on rough surfaces.



HEAVY DUTY POLYPROPYLENE

Premium heavy duty fiber made to sweep heavy debris and resistant to harsh environments and surfaces.

UTILITY REFUSE AND RECYCLING

DECORATIVE REFUSE

CLEANING

MATERIAL HANDLING

WASHROOM

FOODSERVICE

ACCESSORIES & INDEX

Anti-Twist Threaded Push Brooms

- Up to 40% more bristles* to remove more debris in every sweep
- Patented, anti-twist support bracket prevents handle from loosening for fewer job interruptions
- Broom bristles are staple set in a heavy duty resin block that won't warp, rot, or crack under normal usage
- Choose from Fine Polyethylene (PET), Fine Tampico, Fine Horsehair, Multi-Surface, Heavy Duty Polypropylene, and Heavy Duty Palmyra bristles
- Handles and heads sold together



NO.	THREAD COLOR	DESCRIPTION	BRISTLE TYPE	BRISTLE U.S. SIZES	HANDLE	BLOCK	BRACE	U.S. SHIP WT/CTN	METRIC SIZES	METRIC SHIP WT/CTN	PACK
2040053		18" Fine Pet	Fine Pet	3"	15/16" Wood	Resin	Anti-Twist		7.62 cm		4
2039998		24" Fine Pet	Fine Pet	3"	15/16" Wood	Resin	Anti-Twist		7.62 cm		4
2040000		24" Fine Tampico	Fine Tampico	3"	15/16" Wood	Resin	Anti-Twist		7.62 cm		4
2039999		24" Fine Horsehair	Fine Horsehair	3"	15/16" Wood	Resin	Anti-Twist		7.62 cm		4
2040055		18" Multi-Surface	Multi-Surface	3"	15/16" Wood	Resin	Anti-Twist		7.62 cm		4
2040045		24" Multi-Surface	Multi-Surface	3"	15/16" Wood	Resin	Anti-Twist		7.62 cm		4
2040046		24" Multi-Surface With Fg Hdl	Multi-Surface	3"	15/16" Fiberglass	Resin	Anti-Twist		7.62 cm		4
2040054		18" Heavy Duty Polypropylene	Heavy Duty Pp	4"	15/16" Wood	Resin	Anti-Twist		10.16 cm		4
2040041		24" Heavy Duty Palmyra	Hvy Duty Palmyra	4"	15/16" Wood	Resin	Anti-Twist		10.16 cm		4
2040050		24" Heavy Duty Polypropylene	Heavy Duty Pp	4"	15/16" Wood	Resin	Anti-Twist		10.16 cm		4

Assembled Push Brooms

- Up to 40% more bristles* for efficient debris removal
- Fully assembled, permanent steel brace and die-cast aluminum connector for durability
- Choose from Fine Polyethylene (PET), Multi-Surface, Medium Polypropylene, and Heavy Duty Polypropylene bristles
- Handles and heads sold together



NO.	THREAD COLOR	DESCRIPTION	BRISTLE TYPE	BRISTLE U.S. SIZES	HANDLE	BLOCK	BRACE	U.S. SHIP WT/CTN	METRIC SIZES	METRIC SHIP WT/CTN	PACK
2040052		24" Fine Pet Assembled	Fine Pet	3"	1 1/8" Wood	Wood	Steel		7.62 cm		4
2040049		36" Fine Polypropylene	Fine Pet	3"	1 1/8" Wood	Wood	Steel		7.62 cm		4
2040048		24" Multi-Surface With Squeegee	Multi-Surface	3"	15/16" Wood	Resin	Steel		7.62 cm		4
2040047		24" Medium Polypropylene Assembled	Medium Pp	3"	1 1/8" Wood	Wood	Steel		7.62 cm		4
2040042		24" Multi-Surface Assembled With Fg Hdl	Multi-Surface	3"	1 1/4" Fiberglass	Resin	Steel		7.62 cm		4
2040044		36" Medium Polypropylene Assembled	Medium Pp	3"	1 1/8" Wood	Wood	Steel		7.62 cm		4
2040043		24" Heavy Duty Polypropylene Assembled	Heavy Duty Pp	4"	1 1/8" Wood	Wood	Steel		10.16 cm		4
2040051		36" Heavy Duty Polypropylene Assembled	Heavy Duty Pp	4"	1 1/8" Wood	Wood	Steel		10.16 cm		4

MAXIMIZER™ Push-to-Center Brooms

- Angled sides capture more debris per stroke*
- Durable polypropylene bristles can be used on smooth and rough surfaces, effectively sweeping different debris types
- PVC bristles remove fine dirt and debris on smooth, polished surfaces
- Polypropylene foam block resists cracking, splitting, warping and rotting

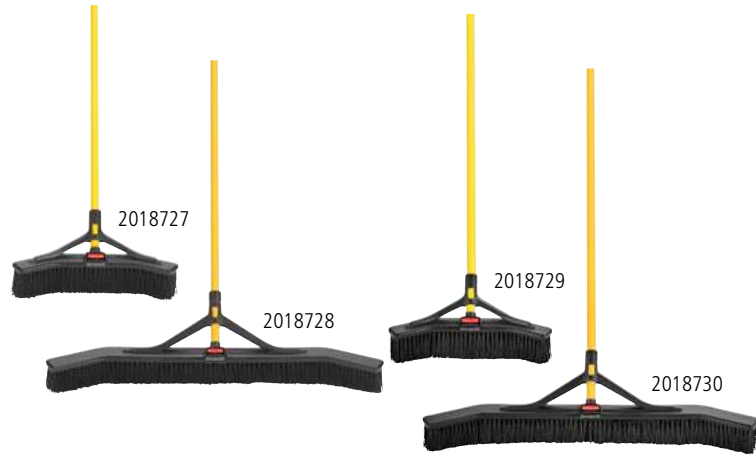

NO.	COLOR	DESCRIPTION	U.S. DIMENSIONS	U.S. SHIP WT/CTN	METRIC DIMENSIONS	METRIC SHIP WT/CTN	PACK
2018727	BLACK	Maximizer™ Push-To-Center Broom – 18" MP	58.1" l x 8.3" w x 7.8" h	2.50 lb	147.6 cm x 21.1 cm x 19.8 cm	1.13 kg	6
2018728	BLACK	Maximizer™ Push-To-Center Broom – 36" MP	58.1" l x 8.3" w x 8.8" h	3.30 lb	147.6 cm x 21.1 cm x 22.4 cm	1.50 kg	6
2018729	GRAY	Maximizer™ Push-To-Center Broom – 18" Fine	58.1" l x 8.3" w x 7.8" h	2.50 lb	147.6 cm x 21.1 cm x 19.8 cm	1.13 kg	6
2018730	GRAY	Maximizer™ Push-To-Center Broom – 36" Fine	58.1" l x 8.3" w x 8.8" h	3.30 lb	147.6 cm x 21.1 cm x 22.4 cm	1.50 kg	6

*(vs. standard RCP push brooms)

Street Sweep

For the most demanding rough surfaces.

- Wide flared ends for greater floor coverage and ease when sweeping close to walls or curbs
- Polypropylene bristles are washable for long life
- Accepts tapered handles
- *Handles sold separately*; see below



NO.	BRISTLE COLOR	DESCRIPTION	TRIM LENGTH	U.S. DIMENSIONS	U.S. SHIP WT/CTN	METRIC DIMENSIONS	METRIC SHIP WT/CTN	PACK
FG982200	BRN	Plastic Foam Block, Medium Floor Sweep, Tampico Fill	6"	16" l	12.4 lb	40.6 cm	5.6 kg	4

Broom Handles

Available in threaded or tapered tips.

- Available in wood or lightweight aluminum



Threaded

NO.	COLOR	DESCRIPTION	U.S. DIMENSIONS	U.S. SHIP WT/CTN	METRIC DIMENSIONS	METRIC SHIP WT/CTN	PACK
FG635100	LAC	Wood Handle, Threaded, Lacquered	1.06" dia x 54" l	11.0 lb	2.7 cm dia x 137.2 cm	5 kg	12
FG635500	GRAY	Aluminum Handle, Threaded Plastic Tip, Vinyl Grip	1" dia x 57" l	10.3 lb	2.5 cm dia x 144.8 cm	4.7 kg	12
FG635700	BLA	Super Self-Locking Wood Handle, Threaded Metal Tip	1.06" dia x 60" l	13.7 lb	2.7 cm dia x 152.4 cm	6.2 kg	12
FG636100	LAC	Wood Handle, Threaded, Lacquered	1.06" dia x 60" l	13.4 lb	2.7 cm dia x 152.4 cm	6.1 kg	12
FG636400	LAC	Wood Handle, Threaded Metal Tip, Lacquered	1.06" dia x 60" l	13.0 lb	2.7 cm dia x 152.4 cm	5.9 kg	12

Tapered

NO.	COLOR	DESCRIPTION	U.S. DIMENSIONS	U.S. SHIP WT/CTN	METRIC DIMENSIONS	METRIC SHIP WT/CTN	PACK
FG635200	NAT	Wood Handle, Tapered, Sanded	1.13" dia x 54" l	16.2 lb	2.9 cm dia x 137.2 cm	7.3 kg	12
FG636200	NAT	Wood Handle, Tapered, Sanded	1.13" dia x 60" l	16.1 lb	2.9 cm dia x 152.4 cm	7.3 kg	12

When ordering products with **BOLD** color codes, please specify color code after the product number. Refer to the Standard Color Guide at the back of the catalog.

UTILITY REFUSE AND RECYCLING

DECORATIVE REFUSE

CLEANING

MATERIAL HANDLING

WASHROOM

FOODSERVICE

ACCESSORIES & INDEX

Angle Brooms

Ideal for cleaning hard-to-reach areas.

- Cut and shaped for easy sweeping
- Long-lasting, stain-resistant polypropylene bristles
- Permanent fusion-set bristles won't pull out
- Available permanent fusion-set bristles won't pull out (only for FG639700GRAY)



NO.	COLOR	DESCRIPTION	SWEEP FACE	U.S. SHIP WT/CTN	METRIC SHIP WT/CTN	PACK
FG637500	GRAY	Broom, 1" dia (2.5 cm) Vinyl-Coated Metal Handle, Flagged Polypropylene Fill	10.5"	10.2 lb	4.6 kg	6
1861076	BLACK	Executive Angle Broom w/ Vinyl Handle	10.5"	10.2 lb	4.6 kg	6
FG638500	GRAY	Broom, 1" dia (2.5 cm) Metal Handle, Flagged Polypropylene Fill	10.5"	9.6 lb	4.4 kg	6
1861078	BLACK	Executive Angle Broom w/ Aluminum Handle	10.5"	9.6 lb	4.4 kg	6
FG638906	BLA	Jumbo Smooth Sweep Angle Broom, 1 1/8" dia (4.76 cm) Black Metal Handle, Polypropylene Fill	10"	26.5 lb	12 kg	6
FG639700	GRAY	Broom Replacement Head, Thread fits FG635100, FG635500 Handles	10.5"	12 lb	5.4 kg	12

Corn Brooms

Designed for rugged indoor/outdoor cleaning.

- 100% natural broom corn fibers for long life and effective pickup
- Remove fine dirt from even or rough surfaces
- Hand-selected, heavy-duty lacquered pine handles



NO.	THREAD COLOR	DESCRIPTION	SWEEP FACE	U.S. SIZES	U.S. SHIP WT/CTN	METRIC SIZES	METRIC SHIP WT/CTN	PACK
FG638300	BLUE	Corn Broom, Warehouse, 1.13" dia (2.9 cm) Stained/Lacquered Handle	12"	31 lb	30.0 lb	14.1 kg	13.6 kg	12
FG638400	ORAN	Corn Broom, Warehouse, 1.13" dia (2.9 cm) Stained/Lacquered Handle	12"	35.5 lb	35.5 lb	15.9 kg	16.1 kg	12

Lobby Pro® Upright Dust Pans

Stylish pan design.

- Durable rear wheels improve wear resistance and extend product life
- Self-opening and closing lid (on FG253200 and FG253300) conceals unsightly dirt and debris
- Adjustable handle grip enhances user comfort (standard on FG253300)
- Bracket and brooms sold separately



NO.	COLOR	DESCRIPTION	U.S. DIMENSIONS	U.S. SHIP WT/CTN	METRIC DIMENSIONS	METRIC SHIP WT/CTN	PACK
FG253100	BLA	Executive Lobby Pro® Dust Pan, Long Handle	12.8" l x 11.3" w x 5" h	13.0 lb	32.5 cm x 28.7 cm x 12.7 cm	5.9 kg	6
FG253200	BLA	Executive Lobby Pro® Dust Pan with Cover, Long Handle	12.8" l x 11.3" w x 5" h	13.0 lb	32.5 cm x 28.7 cm x 12.7 cm	5.9 kg	6
FG253300	BLA	Lobby Pro® Deluxe Upright Dust Pan with Cover and Adjustable Handle Grip	12.8" l x 11.3" w x 5" h	16.3 lb	32.5 cm x 28.7 cm x 12.7 cm	7.4 kg	6
FG253400	BLA	Lobby Pro® Upright Dust Pan Adjustable Handle Grip	11.5" l x 6" w x 1.75" h	2.4 lb	29.2 cm x 15.2 cm x 4.4 cm	1.1 kg	6
FG253500	BLA	Lobby Pro® Upright Dust Pan Hanger Bracket	4" l x 1.25" w x 1.25" h	0.6 lb	10.2 cm x 3.2 cm x 3.2 cm	0.3 kg	6
FG253600	BLA	Executive Lobby Broom w/ Wood Handle	7" l x 37.5" h	2.0 lb	17.8 cm x 95.3 cm	0.9 kg	12
FG637300	BRN	Lobby Broom, 100% Corn Fill	8" l x 1.5" w x 38" h	10.0 lb	20.3 cm x 3.8 cm x 96.5 cm	4.5 kg	12
FG637400	BLA	Executive Lobby Broom w/ Vinyl Handle	7.5" l x 2" w x 35" h	6.6 lb	19.1 cm x 5.1 cm x 88.9 cm	3 kg	6



BRUSH CONSTRUCTION GUIDE

FILL—NATURAL



PALMYRA

Medium to highly stiff fiber from the Palmyra Palm provides durability and good bristle recovery. Can be used wet or dry.

FILL—SYNTHETIC



NYLON

Very durable with excellent abrasion resistance, shear/break strength, and bristle bend recovery. Will not stain, discolor, or absorb odors. Can be used wet or dry and resistant to alkalis and most solvents.



POLYSTYRENE

Extremely durable. Excellent bristle bend recovery and shear/break strength. Resistant to water, oils, and solvents. Not for sweeping compounds or oily surfaces.



POLYPROPYLENE

Very durable with good abrasion resistance and shear/break strength. Will not stain, discolor, or absorb odors. Resistant to solvents, acids, oils, fungus, and bacteria growth. Can be used wet or dry.

FILL—WIRE/METAL



BRASS

Provides a high degree of abrasion without severely scratching hard surfaces. Will not rust. Best for heavy cleaning of metal or brick surfaces that cannot sustain heavy scratches.



TEMPERED STEEL

Provides a high degree of abrasion and wear resistance. Good bend recovery. Best for aggressively removing residue from metal parts or brick work.

Plastic-Handle Utility Brushes

Long or short handles, synthetic and natural brushes.

- All-plastic structural foam blocks have hang-up hole for easy storage
- Available in both synthetic and natural Tampico bristles
- Ideal for foodservice applications and institutional use
- Choice of 8" or 20" length



FG9B3200

FG9B2900

NO.	BRISTLE COLOR	DESCRIPTION	TRIM LENGTH	U.S. DIMENSIONS	U.S. SHIP WT/CTN	METRIC DIMENSIONS	METRIC SHIP WT/CTN	PACK
FG9B2900	YEL	Short Plastic-Handle Utility Brush, Synthetic Fill	2"	8" l	3.3 lb	20.3 cm	1.5 kg	6
FG9B3200	YEL	Long Plastic-Handle Utility Brush, Synthetic Fill	2"	20" l	6.0 lb	50.8 cm	2.7 kg	6

When ordering products with **BOLD** color codes, please specify color code after the product number. Refer to the Standard Color Guide at the back of the catalog.

UTILITY REFUSE AND RECYCLING

DECORATIVE REFUSE

CLEANING

MATERIAL HANDLING

WASHROOM

FOODSERVICE

ACCESSORIES & INDEX

Truck and Wash Brush and Floor/Deck Scrub

Plastic blocks resist splitting and delaminating.

- Flagged synthetic fibers help avoid scratching
- Long-lasting, stain-resistant polypropylene bristles
- Extension poles and acme-thread Quick-Connect Adapter available (see page 81)
- *Handles sold separately*



FGQ70100 QUICK-CONNECT ADAPTER

Use HYGEN™ Quick-Connect handles and extension poles with any standard threaded tool.



FG633700



FG9B3400



FG9B3600



FG9B7200 / FG9B3700



NO.	BRISTLE COLOR	DESCRIPTION	ACCEPTED HANDLE	TRIM LENGTH	U.S. DIMENSIONS	U.S. SHIP WT/CTN	METRIC DIMENSIONS	METRIC SHIP WT/CTN	PACK
FG633700	BLUE	Floor Scrub, Plastic Block, Bi-level, Polypropylene Fill	Threaded	2"	10" l	7.5 lb	25.4 cm	3.4 kg	6
FG9B3400	BRN	Deck Brush, Plastic Block, Palmyra Fill	Threaded	2"	10" l	4.2 lb	25.4 cm	1.9 kg	6
FG9B3600	YEL	Deck Brush, Plastic Block, Polypropylene Fill	Threaded	1"	9" l	3.0 lb	22.9 cm	1.4 kg	6
FG9B3700	GRAY	Wash Brush, Plastic Block, Flagged Polystyrene Fill	Threaded or Tapered	2.5"	10" l	4.5 lb	25.4 cm	2 kg	6
FG9B7200	GRN	Wash Brush, Plastic Block, Nylon Fill	Threaded or Tapered	2.56"	10" l	4.5 lb	25.4 cm	2 kg	6

Wire Brushes

Designed for tough use in difficult areas.

- For efficient removal of rust, paint, and grease
- Wire or steel bristles tackle tough cleaning jobs
- Includes convenient hole for hanging



FG9B4400



FG9B5700

NO.	BRISTLE COLOR	DESCRIPTION	BRISTLE PATTERN	WIRE TYPE	U.S. DIMENSIONS	U.S. SHIP WT/CTN	METRIC DIMENSIONS	METRIC SHIP WT/CTN	PACK
FG9B4400	GRAY	Wire Brush with Scraper, Long Plastic Handle	3 x 19	Steel	14" l	5.3 lb	35.6 cm	2.4 kg	12
FG9B5700	0000	Tile and Grout Brush, Brass Bristles	2 x 9	Brass	8.5" l	1.2 lb	21.6 cm	0.5 kg	12

Scrub Brushes

Natural and synthetic fibers set in plastic block.

- Designed to make scrubbing tile and grout lines and cleaning floors, baseboards, walls, and countertops easier



FG9B5600



FG648200

NO.	COLOR	DESCRIPTION	TRIM LENGTH	U.S. DIMENSIONS	U.S. SHIP WT/CTN	METRIC DIMENSIONS	METRIC SHIP WT/CTN	PACK
FG648200	COBLT	Iron Handle Scrub Brush, Polypropylene Fill	1"	6" l	3.4 lb	15.2 cm	1.5 kg	12
FG9B5600	BLA	Tile and Grout Brush, Plastic Bristles	.75"	8.5" l	0.8 lb	21.6 cm	0.4 kg	12

UTILITY REFUSE AND RECYCLING

DECORATIVE REFUSE

CLEANING

MATERIAL HANDLING

WASHROOM

FOODSERVICE

ACCESSORIES & INDEX



Toilet Bowl Brushes and Holders

Available in several handle lengths, head sizes and styles.

- Polypropylene and crimped polypropylene fills
- Stain- and odor-resistant



NO.	COLOR	DESCRIPTION	TRIM LENGTH	U.S. DIMENSIONS	U.S. SHIP WT/CTN	METRIC DIMENSIONS	METRIC SHIP WT/CTN	PACK
FG631000	WHT	Toilet Bowl Brush, Plastic Handle, Polypropylene Fill	1.13"	14.5" l	7.0 lb	36.8 cm	3.2 kg	24
FG631100	WHT	Toilet Bowl Brush Holder, fits FG631000 Brush		5" l	6.5 lb	12.7 cm	2.9 kg	24
FG632000	BRN	Toilet Bowl Brush, Plastic Handle, Polypropylene Fill	1.5"	17" l	6.0 lb	43.2 cm	2.7 kg	12

Wall Washer Kit

Pivoting head for smooth, even control.

- Raised-ribbed design works with either side-press or down-press mop wringers without requiring additional adapters
- Washable pads remove easily for laundering



NO.	COLOR	DESCRIPTION	U.S. DIMENSIONS	U.S. SHIP WT/CTN	METRIC DIMENSIONS	METRIC SHIP WT/CTN	PACK
FGS21600	GY00	Wall Washer Kit Includes 1 Wood Handle, 1 Plastic Head, 2 Cotton Pads	60" l	2.0 lb	152.4 cm	0.9 kg	1
FGS22600	GY00	Wall Washer Kit Includes 1 Aluminum Handle, 1 Plastic Head, 2 Cotton Pads	60" l	2.0 lb	152.4 cm	0.9 kg	1
FGS29900	WH00	Wall Washer Replacement Pads, Launderable Cotton	9" l x 5" w	8.0 lb	22.9 cm x 12.7 cm	3.6 kg	12

Counter Brushes/Whisk Broom/Heavy-Duty Dust Pans

Perfect for quick cleanups.

- Counter brushes feature structural foam blocks with tampico or polypropylene fills
- Heavy-duty plastic dust pans come in extra-large sizes to hold ample amounts of dirt and debris



NO.	COLOR	DESCRIPTION	SWEEP FACE	U.S. DIMENSIONS	U.S. SHIP WT/CTN	METRIC DIMENSIONS	METRIC SHIP WT/CTN	PACK
FG634100	BLA	Plastic Block Counter Brush, Tampico Fill with 8" (20.3 cm) Bristle Coverage	8"	12.5" l	3.1 lb	31.8 cm	1.4 kg	6
FG634200	SILV	Plastic Block Counter Brush, Flagged Polypropylene Fill with 8" (20.3 cm) Bristle Coverage	8"	12.5" l	3.0 lb	31.8 cm	1.4 kg	6
FG9B5500	YEL	Corn Whisk Broom	N/A	12.25" l	5.0 lb	31.1 cm	2.3 kg	12
FG200500	CHAR	Heavy-Duty Dust Pan	N/A	12.25" l x 8.25" w	6.2 lb	31.1 cm x 21 cm	2.8 kg	12
FG9B5900	BLA	Extra-Large Dust Pan	N/A	16" l x 14.75" w x 5.38" h	5.3 lb	40.6 cm x 37.5 cm x 13.7 cm	2.4 kg	6
FG9B6000	BLA	Jumbo Dust Pan	N/A	22" l x 18" w x 7.75" h	8.7 lb	55.9 cm x 45.7 cm x 19.7 cm	3.9 kg	6

UTILITY REFUSE AND RECYCLING

DECORATIVE REFUSE

CLEANING

MATERIAL HANDLING

WASHROOM

FOODSERVICE

ACCESSORIES & INDEX

Floor Squeegees

Dual Moss Squeegees

- Nonmarking, flexible blades are ideal for uneven surfaces
- Leaves floors virtually dry to the touch, ideal for spills
- For use in removing liquids and light dirt
- *Handles sold separately*

Traditional Squeegees

- Galvanized metal frame and locking strip
- Fit standard 1 1/8" tapered handles
- Nonmarking 2" black rubber blades
- For removing liquids and heavy dirt
- *Handles sold separately*

Professional Plastic Squeegees

- Rugged, corrosion-resistant polypropylene
- Twin black rubber blades
- For removing liquids, moderate dirt, and quick drying
- Scrub and Dry Squeegee with bristles for extra aggressive scrubbing
- Neoprene has excellent resistance to oils, grease, and most chemicals
- *Handles sold separately*



FG9C2600



FG9C2900



FG9C3100



FG9C3400



FG9C4100

Dual Moss Squeegees

NO.	COLOR	DESCRIPTION	U.S. DIMENSIONS	U.S. SHIP WT/CTN	METRIC DIMENSIONS	METRIC SHIP WT/CTN	PACK
FG9C2600*	BLA	18" (45.7 cm) Standard Floor Squeegee	18" l x 3" w x 4.5" h	5.5 lb	45.7 cm x 7.6 cm x 11.4 cm	2.5 kg	10
FG9C2700*	BLA	22" (55.9 cm) Standard Floor Squeegee	22" l x 3" w x 4.5" h	6.6 lb	55.9 cm x 7.6 cm x 11.4 cm	3 kg	10
FG9C2800*	BLA	22" (55.9 cm) Heavy-Duty Floor Squeegee	22" l x 3.25" w x 5.5" h	13.6 lb	55.9 cm x 8.3 cm x 14 cm	6.2 kg	10
FG9C2900*	BLA	30" (76.2 cm) Heavy-Duty Floor Squeegee	30" l x 3.25" w x 5.5" h	15.8 lb	76.2 cm x 8.3 cm x 14 cm	7.2 kg	10

*Use with tapered or wood handles; see page 128.

Traditional Squeegees

NO.	COLOR	DESCRIPTION	U.S. DIMENSIONS	U.S. SHIP WT/CTN	METRIC DIMENSIONS	METRIC SHIP WT/CTN	PACK
FG9C3100*	BLA	18" (45.7 cm) Straight Floor Squeegee	18" l x 4" w x 6.8" h	11.1 lb	45.7 cm x 10.2 cm x 17.3 cm	5 kg	6
FG9C3200*	BLA	24" (61 cm) Straight Floor Squeegee	24" l x 4" w x 6.8" h	13.7 lb	61 cm x 10.2 cm x 17.3 cm	6.2 kg	6
FG9C3300*	BLA	36" (91.4 cm) Straight Floor Squeegee	36" l x 4" w x 6.8" h	19.8 lb	91.4 cm x 10.2 cm x 17.3 cm	9 kg	6
FG9C3400*	BLA	24" (61 cm) Curved Floor Squeegee	23.5" l x 4" w x 6.8" h	13.7 lb	59.7 cm x 10.2 cm x 17.3 cm	6.2 kg	6
FG9C3500	BLA	18" (45.7 cm) Replacement Blade for FG9C3100	18" l x 0.25" w x 2" h	2.7 lb	45.7 cm x 0.6 cm x 5.1 cm	1.2 kg	6
FG9C3600	BLA	24" (61 cm) Replacement Blade for FG9C3200	24" l x 0.25" w x 2" h	3.6 lb	61 cm x 0.6 cm x 5.1 cm	1.6 kg	6
FG9C3700	BLA	36" (91.4 cm) Replacement Blade for FG9C3300	36" l x 0.25" w x 2" h	5.2 lb	91.4 cm x 0.6 cm x 5.1 cm	2.4 kg	6

*Use with tapered or wood handles; see page 128.

Professional Plastic Squeegees

NO.	COLOR	DESCRIPTION	U.S. DIMENSIONS	U.S. SHIP WT/CTN	METRIC DIMENSIONS	METRIC SHIP WT/CTN	PACK
FG9C4100*	BLA	18" (45.7 cm) Plastic Professional Squeegee with Black Dual Moss Rubber	18" l x 2.3" w x 3.5" h	6.0 lb	45.7 cm x 5.8 cm x 8.9 cm	2.7 kg	6
FG9C4200*	BLA	18" (45.7 cm) Plastic Scrub and Dry Squeegee with Black Dual Moss Rubber	18" l x 2.3" w x 3.5" h	7.0 lb	45.7 cm x 5.8 cm x 8.9 cm	3.2 kg	6

Lobby Pro® Wet/Dry Spill

Quick, safe, and easy cleanup of wet or dry spills.

- Cleaning wand handle allows wide area cleaning without bending
- Soft, natural double-moss blade conforms to uneven surfaces, leaving floors virtually dry to the touch
- Yoke attaches outside pan to help keep hinges free of debris
- Indented footrest lets worker hold pan in place and use two hands while cleaning
- Recessed area contains up to 70.4 oz (2 L) of liquid
- Smooth interior surface for easy cleaning and reduced dirt buildup



FG9M0100

NO.	COLOR	DESCRIPTION	U.S. DIMENSIONS	U.S. SHIP WT/CTN	METRIC DIMENSIONS	METRIC SHIP WT/CTN	PACK
FG9M0100	BLA	Lobby Pro® Wet/Dry Cleaning Wand	13.5" l x 1.9" w x 50" h	5.0 lb	34.3 cm x 4.8 cm x 127 cm	2.3 kg	4
FG253500	BLA	Lobby Pro® Upright Dust Pan Hanger Bracket	4" l x 1.25" w x 1.25" h	0.6 lb	10.2 cm x 3.2 cm x 3.2 cm	0.3 kg	6

UTILITY REFUSE
AND RECYCLING

MAXIMIZER™ Wet/Dry Debris Pan

- Holds 10X More Liquid* for efficient clean up and less rework
- The wide opening allows liquid and solid debris to easily collect in the pan
- Molded-in baffles keep both dry and wet debris from leaking back onto floors
- Holds up to 32oz of liquid
- Comes with convenient Hanger Bracket to hold handles

DECORATIVE REFUSE

MAXIMIZER™ Broomgee™

- Double-sided Broomgee™ effectively cleans both liquid and solid spills
- Durable polypropylene bristles effectively sweep up solid debris
- Long-lasting 2.5" TPE squeegee blade handles even the toughest liquid spills
- Broomgee™ easily connects to the Hanger Bracket on Wet/Dry Pan for easy storage

MAXIMIZER™ Heavy Duty Debris Pan

- Extra large opening is wide enough to fit an 18" push broom
- Huge storage capacity reduces trips to empty the pan
- Locking latch for secure lifting and emptying of heavy loads up to 25 lbs.
- Angled, ergonomic handle for reduced strain when sweeping debris into pan
- Durable rear wheels improve wear resistance and extend product life
- Molded comfort handle reduces strain
- Built-in hang hole for convenient storage



CLEANING

NO.	COLOR	DESCRIPTION	U.S. DIMENSIONS	U.S. SHIP WT/CTN	METRIC DIMENSIONS	METRIC SHIP WT/CTN	PACK
2018806	BLACK	Maximizer™ Wet/Dry Debris Pan	29.0" l x 16.9" w x 12.0" h	24.03 lb	73.7 cm x 42.9 cm x 30.5 cm	10.9 kg	6
2018807	BLACK	Maximizer™ Double Sided Broom/Squeegee	44.5" l x 4.1" w x 7.0" h	14.22 lb	113.1 cm x 10.4 cm x 17.8 cm	6.45 kg	8
2018781	BLACK	Maximizer™ Heavy-Duty Stand Up Debris Pan	29.0" l x 20.4" w x 11.0" h	39.6 lb	73.7 cm x 51.8 cm x 27.9 cm	17.96 kg	6

MATERIAL HANDLING

MAXIMIZER™ 3-in-1 Floor Prep Tool

Durable built-in tool attachments deliver easy access and faster cleaning when tackling the toughest messes.

- Gray Scrubber Pad is designed for general cleaning and is made of durable polyester fibers
- Green Scuff Remover Pad lifts stubborn floor scuffs and is made of durable polyester fibers and EVA foam rubber
- Black Scraper removes dry, stuck-on debris and is made of high strength ABS
- Includes lightweight Quick Change Handle for easy tool attachment



WASHROOM

NO.	COLOR	DESCRIPTION	U.S. DIMENSIONS	U.S. SHIP WT/CTN	METRIC DIMENSIONS	METRIC SHIP WT/CTN	PACK
2018782	BLACK	Maximizer™ 3-in-1 Floor Prep Tool	57.0" l x 4.6" w x 4.6" h	11.29 lb	144.8 cm x 11.7 cm x 11.7 cm	5.12 kg	6
2018784	GRAY	Maximizer™ 3-in-1 Medium Scrubber Pad	2.6" l x 1.4" w x 0.3" h	0.24 lb	6.6 cm x 3.6 cm x 0.8 cm	0.11 kg	12
2018786	GREEN	Maximizer™ 3-in-1 Scuff Remover Pad	2.6" l x 1.4" w x 0.5" h	0.30 lb	6.6 cm x 3.6 cm x 1.3 cm	0.14 kg	12
2018787	BLACK	Maximizer™ 3-in-1 Replaceable Scraper	2.6" l x 1.5" w x 0.8" h	0.72 lb	6.6 cm x 3.8 cm x 2.0 cm	0.33 kg	12

FOODSERVICE

ACCESSORIES
& INDEX

*vs. standard RCP Lobby Pro® pans

MAXIMIZER™ Quick Change Cleaning Tools

- Make routine cleaning faster by switching between tools in less time
- Increase accessibility to frequently used cleaning tools by adding onboard storage to current carts
- Compatible with existing RCP microfiber pads and duster sleeves* (*sold separately)
- Select from a microfiber frame, duster, squeegee, scrub brush, and floor prep tool. Add a storage tray for convenient access



2018788



2018789



2018790



2018801



2018804



2018802



2018802

NO.	COLOR	DESCRIPTION	U.S. DIMENSIONS	U.S. SHIP WT/CTN	METRIC DIMENSIONS	METRIC SHIP WT/CTN	PACK
2018788	BLACK	Maximizer™ Quick Change Storage Tray	24.8" l x 19.5" w x 4.0" h	8.00 lb	62.9 cm x 49.5 cm x 10.2 cm	3.6 kg	1
2018789	YELLOW	Maximizer™ Quick Change Extension Handle	35.5" l x 1.8" w x 1.6" h	11.3 lb	90.2 cm x 4.4 cm x 4.1 cm	5.1 kg	12
2018790	BLACK	Maximizer™ Quick Change Duster	25.9" l x 2.1" w x 1.3" h	2.7 lb	65.7 cm x 5.4 cm x 3.2 cm	1.2 kg	6
2018801	BLACK	Maximizer™ Quick Change Squeegee	13.1" l x 10.1" w x 2.1" h	3.2 lb	33.3 cm x 25.7 cm x 5.2 cm	1.5 kg	6
2018802	BLACK	Maximizer™ Quick Change Scrub Brush	11.4" l x 6.0" w x 2.6" h	2.9 lb	28.9 cm x 15.2 cm x 6.7 cm	1.3 kg	6
2018803	BLACK	Maximizer™ Quick Change Floor Prep Tool	9.0" l x 4.8" w x 4.8" h	3.8 lb	22.9 cm x 12.1 cm x 12.1 cm	1.7 kg	6
2018804	BLACK	Maximizer™ Quick Change Microfiber Frame	17.0" l x 3.3" w x 1.5" h	4.3 lb	43.2 cm x 8.3 cm x 3.8 cm	1.9 kg	6
2018805	BLACK	Maximizer™ Quick Change Cleaning Kit	37.0" l x 7.8" w x 3.2" h	3.4 lb	94.0 cm x 19.7 cm x 8.1 cm	1.5 kg	1



EXECUTIVE SERIES™



FG618900BLA

In your world, image makes all the difference. Guests expect a higher caliber of service packaged in a more unique atmosphere. Executive Series™ is a sleek line of cleaning solutions designed to elevate your image by allowing staff to blend into the environment with discreet colors, reduced noise, and concealed supplies.

CLEANING CARTS

- High-Capacity Janitorial Cleaning Cart with Bins 138
- High-Security Janitorial Cleaning Carts..... 138
- High-Capacity Janitorial Cleaning Carts..... 139
- Traditional Janitorial Cleaning Carts..... 139

CLEANING AND HOUSEKEEPING CART ACCESSORIES

- Cleaning, Deluxe Paneled, and Compact Housekeeping Cart Accessories..... 140

TRADITIONAL HOUSEKEEPING CARTS AND ACCESSORIES

- Executive Traditional Housekeeping Carts.. 142
- Housekeeping Cart Bumper Kits..... 143
- Traditional Housekeeping Cart Accessories .. 144

QUICK CARTS

- Executive Quick Carts 145
- Executive Quick Cart – Large 146
- Executive Quick Cart – Medium 146
- Executive Quick Cart – Small 146

MECHANICAL SWEEPERS

- Mechanical Sweeper Selection Guide..... 147
- Executive Single-Action Basic Mechanical Sweeper..... 147
- Executive Dual-Action Bristle Mechanical Sweeper..... 147
- Executive Dual-Action Brushless Mechanical Sweeper..... 147

UTILITY REFUSE AND RECYCLING

DECORATIVE REFUSE

CLEANING

MATERIAL HANDLING

WASHROOM

FOODSERVICE

ACCESSORIES & INDEX



FG9T7500



UTILITY REFUSE
AND RECYCLING

DECORATIVE REFUSE

CLEANING

MATERIAL HANDLING

WASHROOM

FOODSERVICE

ACCESSORIES
& INDEX

High-Capacity Janitorial Cleaning Cart with Bins

Multifunctional system that is great for microfiber or standard cleaning

- Flexible and configurable to fit your ever-changing cleaning needs
- 30-Qt removable bins offer organization and the ability to pre-stock supplies
- Mop bucket platform with securing grooves keeps WaveBrake® or HYGEN™ microfiber charging buckets in place
- Available components vary in color, size, and function to fit your specific needs (see *Cleaning and Housekeeping Cart Accessories*)



FG9T7300BLA

NO.	COLOR	DESCRIPTION	U.S. DIMENSIONS	U.S. SHIP WT/CTN	METRIC DIMENSIONS	METRIC SHIP WT/CTN	PACK
FG9T7300	BLA	Janitorial Cleaning Cart w/Bins – High-Capacity	48.25" l x 22" w x 44" h	53.0 lb	122.6 cm x 55.9 cm x 111.8 cm	24 kg	1
FG9T7400	BLA	Janitorial Cleaning Cart Full Swivel w/Bins – High-Capacity	48.25" l x 22" w x 44" h	53.0 lb	122.6 cm x 55.9 cm x 111.8 cm	24 kg	1

High-Security Janitorial Cleaning Carts

A complete system solution for cleaning your facility.

- Secure cabinet doors keep supplies concealed and locks secure unattended carts
- Interchangeable handles and removable platform allow user to easily expand or reduce the footprint
- Durable 8" wheels and quiet 4" casters provide easy and quiet maneuverability
- Joint Commission-compliant to meet Environment of Care Standard 3.10.3 with locking doors and hood
- Available components vary in color, size, and function to fit your specific needs (see *Cleaning and Housekeeping Cart Accessories*)

PREASSEMBLED LOCKING SECURITY HOOD

Speeds up assembly and ensures all products will be secure



FG9T7500BLA



WASTE COVER AND STORAGE COMPARTMENT

Provides waste coverage and offers functional storage for personal items.

NO.	COLOR	DESCRIPTION	U.S. DIMENSIONS	U.S. SHIP WT/CTN	METRIC DIMENSIONS	METRIC SHIP WT/CTN	PACK
FG9T7500	BLA	Janitorial Cleaning Cart – High-Security	48.25" l x 22" w x 53.5" h	70.0 lb	122.6 cm x 55.9 cm x 135.9 cm	31.8 kg	1
1861427	BLACK	Executive Janitorial Cleaning Cart – High-Security	48.25" l x 22" w x 53.5" h	70.0 lb	122.6 cm x 55.9 cm x 135.9 cm	31.8 kg	1

UTILITY REFUSE AND RECYCLING

DECORATIVE REFUSE

CLEANING

MATERIAL HANDLING

WASHROOM

FOODSERVICE

ACCESSORIES & INDEX

High-Capacity Janitorial Cleaning Cart

Flexible, high-capacity storage solutions and tool organization.

- 7.25-cubic-foot storage capacity offers 40% more space than traditional carts to save time retrieving supplies
- Rubber tool grips securely hold up to 5 stick goods
- Comfort Grip cart handle for easy maneuverability
- Hooks securely hold up to 4 safety signs
- Available components vary in color, size, and function to fit your specific needs (see *Cleaning and Housekeeping Cart Accessories*)



FG9T7200BLA

NO.	COLOR	DESCRIPTION	U.S. DIMENSIONS	U.S. SHIP WT/CTN	METRIC DIMENSIONS	METRIC SHIP WT/CTN	PACK
FG9T7200	BLA	Janitorial Cleaning Cart – High-Capacity	49.75" l x 21.75" w x 38.38" h	45.0 lb	126.4 cm x 55.2 cm x 97.5 cm	20.4 kg	1

Traditional Janitorial Cleaning Carts

Collect waste and transport tools for efficient cleaning.

- Water- and chemical-resistant surface provides easy maintenance and long-lasting good looks
- Front-access zippered bag allows user to easily remove collected waste with no need to lift through the top
- Front platform holds WaveBrake® mop bucket or up to a 32-gallon BRUTE® container
- Add optional Locking Cabinet Doors, Quiet Casters, and Waste Covers



ADD LOCKING CABINET DOORS

Help keep cleaning supplies hidden and secure.



FG617388

EXECUTIVE SERIES™
1861430

NO.	COLOR	DESCRIPTION	U.S. DIMENSIONS	U.S. SHIP WT/CTN	METRIC DIMENSIONS	METRIC SHIP WT/CTN	PACK
FG617388	BLA, BLUE	Janitorial Cleaning Cart – Traditional	46" l x 21.75" w x 38.38" h	49.5 lb	116.8 cm x 55.2 cm x 97.5 cm	22.5 kg	1
1861430	BLACK	Executive Janitorial Cleaning Cart – Traditional	46" l x 21.75" w x 38.38" h	49.5 lb	116.8 cm x 55.2 cm x 97.5 cm	22.5 kg	1
1966719	YELLOW	24-Gal. Janitorial Cleaning Cart Vinyl Bag – Traditional	9.13" l x 6.5" w x 17.25" h	6.33 lb	23.2 cm x 16.5 cm x 43.8 cm	2.87 kg	4
1966720	BLACK	Executive 24-Gal. Janitorial Cleaning Cart Vinyl Bag – Traditional	9.13" l x 6.5" w x 17.25" h	5.64 lb	23.2 cm x 16.5 cm x 43.8 cm	2.56 kg	4
FG618100	YEL	Locking Cabinet Doors	20" l x 16" w x 11.25" h	7.83 lb	50.8 cm x 40.6 cm x 28.6 cm	3.55 kg	1
1861443	BLACK	Executive Janitorial Cleaning Cart Locking Door Kit – Traditional	20" l x 16" w x 11.25" h	7.83 lb	50.8 cm x 40.6 cm x 28.6 cm	3.55 kg	1
FG617900	BLA	Executive Cart Waste/Bag Lid with Storage – High-Capacity	17.63" l x 12.5" w x 2.38" h	3.0 lb	44.8 cm x 31.8 cm x 6 cm	1.4 kg	1

Cleaning Cart Accessories

Improve workflow and increase productivity.*

EXECUTIVE 30-GAL. HIGH-CAPACITY CANVAS VINYL-LINED BAG



1966888

VINYL BAG (34 GAL)



1966881

34-GAL. JANITORIAL CLEANING CART VINYL BAGS



1966882, 1966883, 1966884

EXECUTIVE TRIPLE WASTE WIRE BAG DIVIDER



FG9T89010000

EXECUTIVE 10-QT. HEAVY-DUTY CADDIES



FG9T8200BLA

5-QT HEAVY-DUTY PAILS



1857374, 1857375, 1857376, 1857377

30-QT. ORGANIZING BINS, YELLOW



FG9T8400YEL

EXECUTIVE 9-POCKET FABRIC HANGING ORGANIZER



FG9T9000BLA

Bags and Bag Holders

NO.	COLOR	DESCRIPTION	U.S. DIMENSIONS	U.S. SHIP WT/CTN	METRIC DIMENSIONS	METRIC SHIP WT/CTN	PACK
1966881	YELLOW	34-Gal. Janitorial Cleaning Cart Vinyl Bag – High Capacity	16.8" l x 10.5" w x 33" h	13.0 lb	42.6 cm x 26.6 cm x 83.8 cm	5.9 kg	4
FG9T8200	YEL	10-Quart Heavy-Duty Caddy	16.8" l x 10.5" w x 33" h	13.0 lb	42.6 cm x 26.6 cm x 83.8 cm	5.9 kg	4
1966886	BLACK	Executive 34-Gal. Janitorial Cleaning Cart Vinyl Bag – High-Capacity	16.8" l x 10.5" w x 33" h	10.8 lb	42.6 cm x 26.6 cm x 83.8 cm	4.9 kg	4
1966888	BLACK	Executive 30-Gal. Housekeeping Cart Canvas Vinyl-Lined Bag – High-Capacity	16.8" l x 10.5" w x 33" h	17.3 lb	42.6 cm x 26.6 cm x 83.8 cm	7.9 kg	4
1966882	RED	34-Gal. Janitorial Cleaning Cart Vinyl Bag – High-Capacity	16.8" l x 10.5" w x 33" h	9.9 lb	42.6 cm x 26.6 cm x 83.8 cm	4.5 kg	4
1966883	BLUE	34-Gal. Janitorial Cleaning Cart Vinyl Bag – High-Capacity	16.8" l x 10.5" w x 33" h	9.9 lb	42.6 cm x 26.6 cm x 83.8 cm	4.5 kg	4
1966884	GREEN	34-Gal. Janitorial Cleaning Cart Vinyl Bag – High-Capacity	16.8" l x 10.5" w x 33" h	9.9 lb	42.6 cm x 26.6 cm x 83.8 cm	4.5 kg	4
1966885	BROWN	34-Gal. Janitorial Cleaning Cart Vinyl Bag – High-Capacity	16.8" l x 10.5" w x 33" h	8.4 lb	42.6 cm x 26.6 cm x 83.8 cm	3.8 kg	4
FG9T9000	BLA	Executive Fabric 9-Pocket Organizer	28" l x 19.75" w x 1.5" h	7.3 lb	71.1 cm x 50.2 cm x 3.8 cm	3.3 kg	6
FG9T8901	0000	Executive Triple Waste Wire Bag Divider	12.5" l x 3" w x 0.13" h	2.5 lb	31.8 cm x 7.6 cm x 0.3 cm	1.1 kg	1
1878368		Vacuum Bungees for Carts	N/A	1.0 lb	N/A	0.5 kg	4

Pails, Caddies, and Bins

NO.	COLOR	DESCRIPTION	U.S. DIMENSIONS	U.S. SHIP WT/CTN	METRIC DIMENSIONS	METRIC SHIP WT/CTN	PACK
FG9T8200	BLA	Executive 10-Quart Heavy-Duty Caddy	7.5" l x 14" w x 8" h	10.0 lb	19.1 cm x 35.6 cm x 20.3 cm	4.5 kg	6
1857376	BLUE	5-Quart Pail – Blue	7.5" l x 9.25" w x 8.5" h	6.0 lb	19.1 cm x 23.5 cm x 21.6 cm	2.7 kg	4
1857375	RED	5-Quart Pail – Red	7.5" l x 9.25" w x 8.5" h	6.0 lb	19.1 cm x 23.5 cm x 21.6 cm	2.7 kg	4
1857374	YELLOW	5-Quart Pail – Yellow	7.5" l x 9.25" w x 8.5" h	6.0 lb	19.1 cm x 23.5 cm x 21.6 cm	2.7 kg	4
1857377	GREEN	5-Quart Pail – Green	7.5" l x 9.25" w x 8.5" h	6.0 lb	19.1 cm x 23.5 cm x 21.6 cm	2.7 kg	4
1857378	BLACK	Executive 5-Quart Heavy-Duty Pail – Black	7.5" l x 9.25" w x 8.5" h	6.0 lb	19.1 cm x 23.5 cm x 21.6 cm	2.7 kg	4
FG9T8400	YEL	30-Quart Organizing Bins – Yellow	11" l x 17.5" w x 14" h	7.0 lb	27.9 cm x 44.5 cm x 35.6 cm	3.2 kg	2

*Compatible with all Cleaning Carts, pages 138-139 (excluding FG617388 on page 139)

JANITORIAL CLEANING CART LOCKING DOOR KIT – TRADITIONAL



FG618100YEL

EXECUTIVE LOCKING SECURITY HOOD – HIGH-CAPACITY



FG9T8600BLA

EXECUTIVE WASTE COVER BAG LID WITH STORAGE – HIGH-CAPACITY



FG617900BLA

EXECUTIVE CLEANING CART LOCKING DOOR KIT - HIGH-CAPACITY



1995833

Storage Kits and Casters

NO.	COLOR	DESCRIPTION	U.S. DIMENSIONS	U.S. SHIP WT/CTN	METRIC DIMENSIONS	METRIC SHIP WT/CTN	PACK
FG618100	YEL	Locking Cabinet Doors	20" l x 16" w x 11.25" h	7.83 lb	50.8 cm x 40.6 cm x 28.6 cm	3.6 kg	1
1861443	BLA	Executive Janitorial Cleaning Cart Locking Door Kit – Traditional, Black	19.32" l x 5.45" w x 15.01" h	7.83 lb	49.1 cm x 13.8 cm x 19.3 cm	3.5 kg	1
FG9T8600	BLA	Executive Preassembled Locking Security Hood	9.5" l x 17" w x 19" h	8.0 lb	24.1 cm x 43.2 cm x 48.3 cm	3.6 kg	1
FG617900	BLA	Executive Cart Waste/Bag Lid with Storage – High-Capacity	17.63" l x 12.5" w x 2.38" h	3.0 lb	44.8 cm x 31.8 cm x 6 cm	1.4 kg	1
1868991	BLACK	Executive Cart Waste/Bag Lid – High-Capacity	17.63" l x 12.5" w x 2.38" h	3.0 lb	44.8 cm x 31.8 cm x 6 cm	1.4 kg	1
1878367*	DARK GRAY	Executive Quiet Caster and Ball-Bearing Wheel Kit	N/A	N/A	N/A	N/A	1

*Compatible with all Cleaning Carts, pages 182-185 (excluding FG617388 on page 183)
 **Compatible with Traditional Housekeeping Carts on page 142 and Steel Housekeeping Carts

SLIM JIM® CONTAINER



FG354060GRAY

SLIM JIM® RECYCLING CONTAINER



FG354007BLUE

BRUTE® 44-GALLON CONTAINER



FG264360BLA



BRUTE® 32-GALLON CONTAINER



FG263200GRAY

Slim Jim® and BRUTE® Containers

NO.	COLOR	DESCRIPTION	U.S. DIMENSIONS	U.S. SHIP WT/CTN	METRIC DIMENSIONS	METRIC SHIP WT/CTN	PACK
FG354060	GRAY, BLA, BEIG	Slim Jim® with Venting Channels	22" l x 11" w x 30" h	30.6 lb	55.9 cm x 27.9 cm x 76.2 cm	13.9 kg	4
FG354007	GRN, BLUE	Slim Jim® with Venting Channels – Recycling	22" l x 11" w x 30" h	30.6 lb	55.9 cm x 27.9 cm x 76.2 cm	13.9 kg	4
FG263200	YEL, WHT, RED, GRAY, DGRN, BLUE	BRUTE® 32-Gallon Container	22" dia x 27.25" h	49.5 lb	55.9 cm dia x 69.2 cm	22.5 kg	6
1867531	BLACK	Executive BRUTE® 32-Gallon Container	22" dia x 27.25" h	49.5 lb	55.9 cm dia x 69.2 cm	22.5 kg	6
FG264360	YEL, RED, GRAY, BLUE, BLA	BRUTE® 44-Gallon Utility Container with Venting Channels	24" dia x 31.5" h	49.5 lb	61 cm dia x 80 cm	22.5 kg	4

For more options, see *Utility Refuse and Recycling*.

Executive Traditional Housekeeping Carts

A complete system solution for housekeeping in the hospitality industry.

- Durable commercial-grade construction
- Easy-to-clean surfaces and molded-in color
- Durable nonmarking 8" ball bearing casters allow for easy maneuverability
- Standard equipment includes fabric bag, bumpers, vacuum holder, and under-deck shelf
- Available with or without doors or hood
- Full-size cabinet offers exceptional storage space and adjustable middle shelf, add additional shelves for greater organization
- Fully-rounded, user-friendly handles are easy to grip and assist maneuverability
- Optional accessories enhance functionality and productivity
- Impact-absorbing and non-marring bumpers are designed to reduce costly wall damage



EASY TO MAINTAIN
using genuine Rubbermaid Commercial parts. See Component Parts.



SECURE DOORS KEEP SUPPLIES CONCEALED FOR DISCREET FRONT-OF-HOUSE APPEARANCE

FG619100BLA

MESH FABRIC LINEN BAG
Allows quick and easy access to linens.



PROTECTIVE HOOD
Helps hide soaps and cleaning supplies from guests.

FG9T1900BLA

MULTIPLE FABRIC BAG OPTIONS
Rubbermaid offers a variety of fabric bags that allows the user to order the bags that will best fit their needs.



FG619200BLA

NO.	COLOR	DESCRIPTION	U.S. DIMENSIONS	U.S. SHIP WT/CTN	METRIC DIMENSIONS	METRIC SHIP WT/CTN	PACK
Ⓢ FG618900	BLA	Executive Full-Size Housekeeping Cart – Traditional	60" l x 22" w x 50" h	102.1 lb	152.4 cm x 55.9 cm x 127 cm	46.3 kg	1
Ⓢ FG619000	BLA	Executive Compact Housekeeping Cart – Traditional	49" l x 22" w x 50" h	95.6 lb	124.5 cm x 55.9 cm x 127 cm	43.4 kg	1
Ⓢ FG619100	BLA	Executive Full-Size Housekeeping Cart with Doors – Traditional	60" l x 22" w x 50" h	108.8 lb	152.4 cm x 55.9 cm x 127 cm	49.4 kg	1
Ⓢ FG619200	BLA	Executive Compact Housekeeping Cart with Doors – Traditional	49" l x 22" w x 50" h	102.3 lb	124.5 cm x 55.9 cm x 127 cm	46.4 kg	1
Ⓢ FG9T1900	BLA	Executive Full-Size Housekeeping Cart with Doors and Hood – Traditional	60" l x 22" w x 67.5" h	126.3 lb	152.4 cm x 55.9 cm x 171.5 cm	57.3 kg	1
Ⓢ 1969596	PLATINUM	Executive Full-Size Housekeeping Cart – Traditional	60" l x 22" w x 50" h	102.1 lb	152.4 cm x 55.9 cm x 127 cm	46.3 kg	1

UTILITY REFUSE AND RECYCLING

DECORATIVE REFUSE

CLEANING

MATERIAL HANDLING

WASHROOM

FOODSERVICE

ACCESSORIES & INDEX

Executive Compact Housekeeping Cart

Ergonomic and lightweight housekeeping solutions.

- High capacity-to-footprint ratio; only 22" wide
- Multiple accessories available for a customized solution
- Includes locking security hood and cabinet doors, with access from both sides of cart
- 32% more compact size than our FG9T1900 Cart with Doors and Hood
- Two heavy-duty zippered Compact Fabric Bags with waterproof PVC lining



FG9T7800 shown with optional FG9T9000 9-Pocket Fabric Organizer (see page 140 and 144).

EASY TO MAINTAIN

using genuine Rubbermaid Commercial parts. See *Component Parts*.

NO.	COLOR	DESCRIPTION	U.S. DIMENSIONS	U.S. SHIP WT/CTN	METRIC DIMENSIONS	METRIC SHIP WT/CTN	PACK
FG9T7800	BLA	Executive Housekeeping Compact Cart – High-Security	51.75" l x 22" w x 53.5" h	79 lb	131.4 cm x 55.9 cm x 135.9 cm	35.8 kg	1

Housekeeping Cart Bumper Kits

Impact-absorbing and non-marring bumpers are designed to reduce costly wall damage.

- Kits include four commercial-grade bumpers, wire vacuum rack, hardware, and assembly instructions
- Bumper can be retro-fitted onto all housekeeping carts



2067692

NO.	COLOR	DESCRIPTION	U.S. DIMENSIONS	U.S. SHIP WT/CTN	METRIC DIMENSIONS	METRIC SHIP WT/CTN	PACK
2067692	N/A	Bumper Kit for Full Size Housekeeping Carts	23.5"l x 19.0"w x 3.3"h	6.7 lb	59.63 cm x 48.19 cm x 8.34 cm	3.0 kg	1
2067693	N/A	Bumper Kit for Compact Housekeeping Carts	23.5"l x 19.0"w x 3.3"h	6.7 lb	59.63 cm x 48.19 cm x 8.34 cm	3.0 kg	1



CANVAS LINEN ACCESSORY BAG



1966887

EXECUTIVE 30-GAL. HIGH-CAPACITY CANVAS VINYL-LINED BAG



1966888

EXECUTIVE 9-POCKET FABRIC HANGING ORGANIZER CART CADDY



FG9T9000BLA

EXECUTIVE EASY SIDE-LOAD LINEN BAG



1966889

Bags

NO.	COLOR	DESCRIPTION	U.S. DIMENSIONS	U.S. SHIP WT/CTN	METRIC DIMENSIONS	METRIC SHIP WT/CTN	PACK
1966887	BROWN	30-Gal. Housekeeping Cart Canvas Vinyl-Lined Bag – High-Capacity	16.8" l x 10.5" w x 33" h	5.8 lb	42.6 cm x 26.6 cm x 83.8 cm	2.6 kg	4
FG9T9000	BLA	Executive 9-Pocket Fabric Hanging Organizer Cart Caddy	28" l x 19.75" w x 1.5" h	7.3 lb	71.1 cm x 50.2 cm x 3.8 cm	3.3 kg	6
1966889	BLACK	Executive Side-Load Mesh Linen Bag	16.8" l x 10.5" w x 33" h	6.4 lb	42.6 cm x 26.6 cm x 83.8 cm	2.9 kg	4
1966886	BLACK	Executive 34-Gal. Janitorial Cleaning Cart Vinyl Bag – High-Capacity	16.8" l x 10.5" w x 33" h	10.8 lb	42.6 cm x 26.6 cm x 83.8 cm	4.9 kg	4
1966888	BLA	Executive 30-Gal. Housekeeping Cart Canvas Vinyl-Lined Bag – High Capacity	16.8" l x 10.5" w x 33" h	17.31 lb	42.6 cm x 26.6 cm x 83.8 cm	7.85 kg	4

Traditional Housekeeping Cart Accessories

EXECUTIVE PROTECTIVE SECURITY HOOD FOR TRADITIONAL HOUSEKEEPING CARTS



FG9T0000BLA

EXECUTIVE HOUSEKEEPING CART WASTE/BAG LID – TRADITIONAL



1837785

EXECUTIVE DIVIDED CARRY CADDY, BLACK



1880994

EXECUTIVE LOCKING UTILITY DRAWER – TRADITIONAL



FG619900BLA

Accessories

NO.	COLOR	DESCRIPTION	U.S. DIMENSIONS	U.S. SHIP WT/CTN	METRIC DIMENSIONS	METRIC SHIP WT/CTN	PACK
FG335388	BLA	Refuse Bin	12" l x 17" w x 22" h	9.0 lb	30.5 cm x 43.2 cm x 55.9 cm	4.1 kg	2
FG335488	BLA	Utility Bin	12.13" l x 17" w x 10.5" h	5.4 lb	30.8 cm x 43.2 cm x 26.7 cm	2.4 kg	2
FG619500	PLAT, BLA	Executive Adjustable Shelf Kit for Traditional Housekeeping Carts	30.13" l x 18.5" w x 2.25" h	5.0 lb	76.5 cm x 47 cm x 5.7 cm	2.3 kg	1
FG619600	PLAT, BLA	Executive Glass Rack for Traditional Housekeeping Carts	25.38" l x 21" w x 6.7" h	2.5 lb	64.5 cm x 53.3 cm x 17 cm	1.1 kg	1
FG619700	BLA	Executive Locking Door Kit for Traditional Housekeeping Carts	34" l x 1.88" w x 31.63" h	6.7 lb	86.4 cm x 4.8 cm x 80.3 cm	3 kg	1
FG619900	BLA	Executive Locking Utility Drawer – Traditional	N/A	4.5 lb	N/A	2 kg	1
FG9T0000	PLAT, BLA	Executive Protective Security Hood for Traditional Housekeeping Carts	31.63" l x 20.38" w x 17.5" h	21.5 lb	80.3 cm x 51.8 cm x 44.5 cm	9.8 kg	1
1837785	BLACK	Executive Housekeeping Cart Waste/Bag Lid – Traditional	12.28" l x 18.53" w x 0.5" h	1.7 lb	31.2 cm x 47.1 cm x 1.3 cm	0.8 kg	1
1880994	BLACK	Executive Divided Carry Caddy					6
1880995	GRAY	Executive Divided Carry Caddy					6
1966888	BLACK	Executive 30-Gal. Housekeeping Cart Canvas Vinyl Lined Bag – High Capacity	16.8" l x 10.5" w x 33" h	17.31 lb	42.6 cm x 26.6 cm x 83.8 cm	7.85 kg	4
FG616200	0000	Dual Waste Wire Bag Holder	12.5" l x 3" w x 0.13" h	2.5 lb	31.8 cm x 7.6 cm x 0.3 cm	1.1 kg	6
FG616300	0000	Single Waste Wire Bag Holder	20" l x 16" w x 11.25" h	7.8 lb	50.8 cm x 40.6 cm x 28.6 cm	3.5 kg	6
1966889	BLACK	Executive Side-Load Mesh Linen Bag	16.8" l x 10.5" w x 33" h	6.4 lb	42.6 cm x 26.6 cm x 83.8 cm	2.9 kg	4
1975229**		Executive 8" Quiet Caster – Swivel Fixed Pack 2	N/A	N/A	N/A	N/A	1
1975230**		Executive 8" Quiet Caster – Fixed Pack 2	N/A	N/A	N/A	N/A	1



Executive Quick Carts

The industry's most durable mobile cart solution that empowers staff to maintain areas discreetly and efficiently.

- Provide a premium guest experience, keeping the cleaning process hidden from view of guests
- Easily move throughout the property with a lightweight, compact, and durable construction
- Deliver a flexible solution, customizable for the unique needs of your property



EXECUTIVE SERIES™



Repels Water, Oil, and Stains
Teflon™ fabric protector helps maintain Quick Cart aesthetics and protects from rigorous daily use.



Secured Stick Goods
Heavy-duty fastening strap wraps around supplies to keep them secure while the cart is in motion.



Secure Supplies
Durable lid conceals supplies and features hardware for adding a lock to prevent unauthorized access to cart and its contents.



Heavy-Duty Kick Plate
Reinforced rubberized kick plate for increased durability and reduced wear and tear.

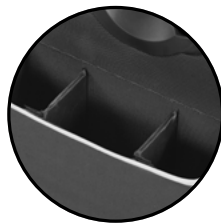

Adjustable Dividers
Dividers can be moved or removed to create multiple compartments to meet your specific cleaning needs.



1902465 Executive Quick Cart – Large



Removable Carry Caddy
Rigid dividers improve efficiency, keeping amenities and supplies organized.

Teflon™ is a registered trademark of Chemours used under license by Rubbermaid Commercial Products LLC.



Executive Quick Cart – Large

- 60-lb capacity
- 3.55 ft³ of total volume capacity
- High-performance polyester for increased durability
- 6 outer pockets (including 1 plastic lined pocket) and 6 inner pockets
- Pockets, caddy, and main compartment include adjustable dividers
- Large removable caddy included
- Removable inner liner for easy cleaning or replacement



NO.	COLOR	DESCRIPTION	U.S. DIMENSIONS	U.S. CAPACITY	U.S. SHIP WT/CTN	METRIC DIMENSIONS	METRIC CAPACITY	METRIC SHIP WT/CTN	PACK
1902465	DARK GRAY	Executive Quick Cart – Large	16.50" L x 14.25" W x 25.00" H	3.55 ft³ (2.67 ft³)	21.0 lb	41.91 cm L x 36.20 cm W x 63.50 cm H		9.53 kg	1
1902468**	DARK GRAY	Executive Quick Cart Caddy – Large	14.00" L x 11.00" W x 5.50" H	0.36 ft³	5.09 lb	35.56 cm L x 27.94 cm W x 13.97 cm H		2.31 kg	2
1902701	Black	Executive Quick Cart Liner – Large	16.00" L x 12.75" W x 22.25" H		3.10 lb	40.64 cm L x 32.39 cm W x 56.52 cm H		1.40 kg	6
1919270*	Clear	Executive Quick Cart Plastic Pocket Liner	3.75" L x 4.00" W x 8.50" H		0.65 lb	26.67 cm L x 27.94 cm W x 13.97 cm H		0.29 kg	4

*Replacement for all Executive Quick Carts.
 **Replacement for Medium and Large Executive Quick Carts.

Executive Quick Cart – Medium

- 40-lb capacity
- 3.07 ft³ of total volume capacity
- High-performance polyester for increased durability
- 6 outer pockets (including 1 plastic lined pocket) and 6 inner pockets
- Pockets, caddy, and main compartment include adjustable dividers
- Large removable caddy included
- Removable inner liner for easy cleaning or replacement



NO.	COLOR	DESCRIPTION	U.S. DIMENSIONS	U.S. CAPACITY	U.S. SHIP WT/CTN	METRIC DIMENSIONS	METRIC CAPACITY	METRIC SHIP WT/CTN	PACK
1902466	DARK GRAY	Executive Quick Cart – Medium	16.50" L x 14.25" W x 21.00" H	3.07 ft³ (2.19 ft³)	19.2 lb	41.91 cm L x 36.20 cm W x 53.34 cm H		8.71 kg	1
1902468**	DARK GRAY	Executive Quick Cart Caddy – Large	14.00" L x 11.00" W x 5.50" H	0.36 ft³	5.09 lb	35.56 cm L x 27.94 cm W x 13.97 cm H		2.31 kg	2
1902702	Black	Executive Quick Cart Liner – Medium	16.00" L x 12.75" W x 18.50" H		2.83 lb	40.64 cm L x 32.39 cm W x 46.99 cm H		1.28 kg	6
1919270*	Clear	Executive Quick Cart Plastic Pocket Liner	3.75" L x 4.00" W x 8.50" H		0.65 lb	26.67 cm L x 27.94 cm W x 13.97 cm H		0.29 kg	4

*Replacement for all Executive Quick Carts.
 **Replacement for Medium and Large Executive Quick Carts.

Executive Quick Cart – Small

- 30-lb capacity
- 2.80 ft³ of total volume capacity
- 5 outer pockets and 6 inner pockets
- High-performance polyester for increased durability
- Pockets, caddy, and main compartment include adjustable dividers
- Small removable caddy included
- Removable inner liner for easy cleaning or replacement



NO.	COLOR	DESCRIPTION	U.S. DIMENSIONS	U.S. CAPACITY	U.S. SHIP WT/CTN	METRIC DIMENSIONS	METRIC CAPACITY	METRIC SHIP WT/CTN	PACK
1902467	DARK GRAY	Executive Quick Cart – Small	16.50" L x 14.25" W x 17.00" H	2.80 ft³ (1.72 ft³)	17.2 lb	41.91 cm L x 36.20 cm W x 43.18 cm H		7.80 kg	1
1902459***	DARK GRAY	Executive Quick Cart Caddy – Small	10.50" L x 11.00" W x 5.50" H	0.22 ft³	3.72 lb	26.67 cm L x 27.94 cm W x 13.97 cm H		1.69 kg	2
1902703	Black	Executive Quick Cart Liner – Small	16.00" L x 12.75" W x 14.50" H		2.42 lb	40.64 cm L x 32.39 cm W x 36.83 cm H		1.10 kg	6
1919270*	Clear	Executive Quick Cart Plastic Pocket Liner	3.75" L x 4.00" W x 8.50" H		0.65 lb	26.67 cm L x 27.94 cm W x 13.97 cm H		0.29 kg	4

*Replacement for all Executive Quick Carts.
 ***Replacement for Small Executive Quick Carts.

Mechanical Sweepers

A complete line of commercial sweepers for hard floors and carpets.

MECHANICAL SWEEPER SELECTION GUIDE

MECHANICAL SWEEPER FEATURES	FG421588 EXECUTIVE DUAL-ACTION BRUSHLESS MECHANICAL SWEEPER	FG421388 EXECUTIVE DUAL-ACTION BRISTLE MECHANICAL SWEEPER	FG421288 EXECUTIVE SINGLE-ACTION BASIC MECHANICAL SWEEPER
L x W	11 1/4" x 9 1/2"	11 1/4" x 9 1/2"	9 1/4" x 9 1/4"
Sweeping Path	7 1/2"	7 1/2"	6 1/2"
Number of Brushes	Two (Bladed rotors)	Two	One
Debris Capacity	36.8 cu in	36.8 cu in	25 cu in
Debris Canisters	Two with viewing window	Two	One
Corner Brushes	Yes	Yes	Yes
Protective Front and Back Bumper	Yes	Yes	Yes
Soft Handle Grip	Yes	Yes	Yes
Handle Length	40", threaded	40", threaded	40", threaded
Handle Width	5/8"	5/8"	5/8"
Construction	Galvanized steel	Galvanized steel	Galvanized steel
Components	ABS plastic	ABS plastic	ABS plastic
Wheels	Soft rubber	Soft rubber	Soft rubber

Executive Single-Action Basic Mechanical Sweeper

Compact size to collect dust, dirt, and debris in tight spaces.

- Constructed of durable galvanized steel and tough ABS plastic
- Low-profile design provides easy access around and under furniture
- Efficient 6.5" sweep path with protective bumper
- Soft rubber wheels glide easily on any surface
- Easy-to-empty trays
- For carpet, tile, wood, vinyl, and more



BRISTLE BRUSH ROLL



NO.	COLOR	DESCRIPTION	U.S. DIMENSIONS	U.S. SHIP WT/CTN	METRIC DIMENSIONS	METRIC SHIP WT/CTN	PACK
FG421288	BLA	Executive Single-Action Basic Mechanical Sweeper	9.5" l x 8" w x 44" h	15.6 lb	24.1 cm x 20.3 cm x 111.8 cm	7.1 kg	4

Executive Dual-Action Bristle Mechanical Sweeper

Two bristle brush rolls provide effective cleaning power to collect dust, dirt, and debris.

- Constructed of durable galvanized steel and tough ABS plastic
- Low-profile design provides easy access around and under furniture
- Efficient 7.5" sweep path with protective bumper
- Soft rubber wheels glide easily on any surface
- Easy-to-empty trays
- For carpet, tile, wood, vinyl, and more



BRISTLE BRUSH ROLL



NO.	COLOR	DESCRIPTION	U.S. DIMENSIONS	U.S. SHIP WT/CTN	METRIC DIMENSIONS	METRIC SHIP WT/CTN	PACK
FG421388	BLA	Executive Dual-Action Bristle Mechanical Sweeper	10.5" l x 9.5" w x 44" h	19.6 lb	26.7 cm x 24.1 cm x 111.8 cm	8.9 kg	4

Executive Dual-Action Brushless Mechanical Sweeper

Two agitator rolls provide maximum cleaning power to collect dust, dirt, and debris.

- Constructed of durable galvanized steel and tough ABS plastic
- Low-profile design for easy access around and under furniture
- Wide 7.5" sweep path with protective bumper
- Tinted windows allow you to see when the sweeper needs emptying
- Easy-to-empty trays
- Soft rubber wheels glide easily on any surface
- For carpet, tile, wood, vinyl, and more



RUBBER BRUSH ROLL



NO.	COLOR	DESCRIPTION	U.S. DIMENSIONS	U.S. SHIP WT/CTN	METRIC DIMENSIONS	METRIC SHIP WT/CTN	PACK
FG421588	BLA	Executive Dual-Action Brushless Mechanical Sweeper	10.5" l x 9.5" w x 44" h	19.6 lb	26.7 cm x 24.1 cm x 111.8 cm	8.9 kg	4

UTILITY REFUSE AND RECYCLING

DECORATIVE REFUSE

CLEANING

MATERIAL HANDLING

WASHROOM

FOODSERVICE

ACCESSORIES & INDEX



Closet Organizer and Tool Holder

Helps increase productivity and efficiency through better tool storage and access.

- S-hooks hold 5/8" to 1 1/4" diameter handles
- Deep double hooks afford easy accessibility
- Clip holds work notes and instructions

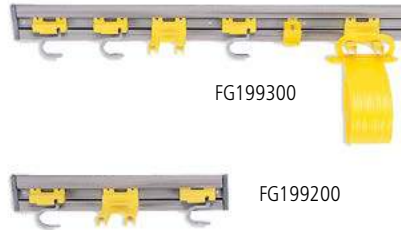

NO.	COLOR	DESCRIPTION	U.S. DIMENSIONS	U.S. SHIP WT/CTN	METRIC DIMENSIONS	METRIC SHIP WT/CTN	PACK
FG199200	GRAY	Closet Organizer/Tool Holder Kit	18" l x 3.25" w x 4.25" h	6.5 lb	45.7 cm x 8.3 cm x 10.8 cm	2.9 kg	6
FG199300	GRAY	Closet Organizer/Tool Holder Kit	34" l x 3.25" w x 4.25" h	10.3 lb	86.4 cm x 8.3 cm x 10.8 cm	4.7 kg	4
FG199400	YEL	Value Kit (2 S-Hooks/1 Double Hook)	3" l x 3.25" w x 4.25" h	0.4 lb	7.6 cm x 8.3 cm x 10.8 cm	0.2 kg	1

Ironing Organizers

Helps prevent hot iron damage.

- Installs easily virtually anywhere
- Efficiently stores iron with ironing board for guest convenience
- Durable heat-resistant thermoset plastic construction
- Aesthetic design complements guest room décor



FG218800



FG245506



FG245506

NO.	COLOR	DESCRIPTION	U.S. DIMENSIONS	U.S. SHIP WT/CTN	METRIC DIMENSIONS	METRIC SHIP WT/CTN	PACK
FG245506	WHT	Ironing Organizer	5.25" l x 15.5" h	10.5 lb	13.3 cm x 39.4 cm	4.8 kg	6
FG218800	WHT	Ironing Organizer	5.75" l x 10" h	5.4 lb	14.6 cm x 25.4 cm	2.4 kg	4

Mobile Two-Step Stepstool

Heavy-duty stepstool glides on retractable rubber casters.

- Supports loads up to 350 lbs
- Soft, slip-resistant pads on both steps
- Wheels retract when stepped on
- Heavy-duty plastic construction minimizes damage to walls and furniture



FG252300

NO.	COLOR	DESCRIPTION	U.S. DIMENSIONS	U.S. SHIP WT/CTN	METRIC DIMENSIONS	METRIC SHIP WT/CTN	PACK
FG252300	BLA, BEIG	Mobile Two-Step Stepstool	16" dia x 13.5" h	5.9 lb	40.6 cm dia x 34.3 cm	2.7 kg	1

UTILITY REFUSE AND RECYCLING

DECORATIVE REFUSE

CLEANING

MATERIAL HANDLING

WASHROOM

FOODSERVICE

ACCESSORIES & INDEX

Executive Spray Bottle, 32-oz.

Makes cleaning easier and more effective.

- Adjustable nozzle, sprays up to 30"
- High-volume 3-cc spray
- Solid HDPE bottle withstands drops and bumps
- Large 3-finger trigger for easy application



EXECUTIVE SERIES
FG9C0306

NO.	COLOR	DESCRIPTION	U.S. DIMENSIONS	U.S. CAPACITY	U.S. SHIP WT/CTN	METRIC DIMENSIONS	METRIC CAPACITY	METRIC SHIP WT/CTN	PACK
FG9C0306	0000	Executive Spray Bottle, 32-oz.	4.8" l x 1.3" w x 13.4" h	3.3 cm ³ /32 oz	4.5 lb	12.2 cm x 3.3 cm x 34 cm	3.3 cm ³ /0.9 L	2.1 kg	12

Deluxe Carry Caddy

All-purpose caddy is perfect for carrying tools or cleaning supplies.

- Heavy-duty caddy conveniently fits on cleaning and housekeeping carts
- Securely holds up to eight 32-oz spray bottles and other common cleaning tools
- Ergonomic handle design provides comfortable fit



EXECUTIVE SERIES
1880995



FG315488

NO.	COLOR	DESCRIPTION	U.S. DIMENSIONS	U.S. SHIP WT/CTN	METRIC DIMENSIONS	METRIC SHIP WT/CTN	PACK
FG315488	BLA	Deluxe Carry Caddy	15" l x 10.9" w x 7.4" h	7.5 lb	38.1 cm x 27.7 cm x 18.8 cm	3.4 kg	6
1880994	BLACK	Executive Divided Carry Caddy	15.2" l x 10.8" w x 6.5" h	1.3 lb	38.7 cm x 27.3 cm x 16.5 cm	0.6 kg	6
1880995	GRAY	Executive Divided Carry Caddy	15.2" l x 10.8" w x 6.5" h	1.3 lb	38.7 cm x 27.3 cm x 16.5 cm	0.6 kg	6

COMPLETE CLEANING SYSTEMS

Rubbermaid Commercial Products' cleaning products are designed to work together to form complete cleaning systems. The FG9C0306 Spray Bottle and Trigger fits smartly in BRUTE® Caddies, and Cleaning Carts.



UTILITY REFUSE AND RECYCLING

DECORATIVE REFUSE

CLEANING

MATERIAL HANDLING

WASHROOM

FOODSERVICE

ACCESSORIES & INDEX



SAFETY





SAFETY SIGNS

Stable Safety Signs 154
 Hanging Safety Sign 154
 Floor Safety Signs 155
 Executive Wooden Multilingual
 Caution Signs 155
 Site Safety Hanging Signs 155

SAFETY CONES

Folding Safety Cones 156
 Pop-Up Safety Cones 156
 Safety Cones and Accessories 156

BARRIERS

Mobile Barrier 157
 Cone Barrier System 157

ABSORBENTS

Over-the-Spill® System 157
 Spill Mop 158
 Biohazard Spill Mop..... 158

LOOK FOR THE SPECIALLY MARKED EXECUTIVE SERIES™ PRODUCTS.

SAFETY



SPILL MOP



HIGHLY ABSORBENT MATERIALS

Absorbs up to 32 ounces (0.94L) of water and cuts the overall time required to completely remove a spill in half versus a cotton string mop, leaving a safer, drier floor.

CONVENIENT DISPOSAL

Integrated release lever helps avoid contact with soiled mop during disposal.

QUICK ACCESS

Storage cabinet mounts to the wall to keep mop pads and handle close at hand.

BIOHAZARD

SPILL MOP



BETTER HEALTH & SAFETY COMPLIANCE

Biohazard Spill Mop Pad material is designed to absorb up to 13 ounces (0.4L) NaCl 0.9% or 32 ounces (0.94L) of water and turn it into a gel to prevent dripping and help make biohazard spill cleanup safe. The mop easily attaches to the mop head and includes an integrated release lever to dispose of the soiled mop, minimizing contact with hazardous materials.



STORE WHERE SPILLS HAPPEN

Biohazard spills can happen anywhere, including patient rooms and other places where space and storage is limited. The Biohazard Spill Mop Pads come in a compact dispensing carton and the handle is collapsible to fit in drawers or under desks. A mountable storage unit can be placed in high traffic areas.

Spills happen unexpectedly, creating hazards for patrons and staff which need to be cleaned up as quickly as possible to avoid injuries. Using a string mop and bucket can be time consuming and leaves the floor wet. Spill Mop makes it easier to quickly remove liquid spills, leaving the floor dry faster.

3 MILLION  **FOOD SERVICE EMPLOYEES ARE INJURED ANNUALLY AS A RESULT OF SLIPS AND FALLS**

11,000 FATAL FALLS OCCUR IN THE HOSPITAL ANNUALLY 

INJURIES ARE INCREASING AT 10% ANNUALLY 

¹ National Floor Safety Institute
² The Joint Commission Center for Transforming Healthcare

Stable Safety Signs

Unique “no tip” design and bold graphics quickly capture pedestrian attention.

- Folds for convenient storage and transport on Janitor Cart (FG617388) or Rim Caddy (FG9W8700)
- Large, 13" warning triangle with bold graphics
- Only 1½" thick when closed
- Self-opening feet provide a wide, stable base
- Low center of gravity helps prevent tipping when bumped, kicked, or windblown
- ANSI- and OSHA-compliant color and graphics**



FG9S0925

NO.	COLOR	DESCRIPTION	U.S. DIMENSIONS	U.S. SHIP WT/CTN	METRIC DIMENSIONS	METRIC SHIP WT/CTN	PACK
FG9S09DP	YEL	Stable Safety Sign with "Caution" Imprint, English, Spanish, French	Open: 26" l x 13" w x 13¼" d Closed: 32¼" l x 13" w x 1½" d	9.5 lb	Open: 66 cm x 33 cm x 33.6 cm Closed: 81.9 cm x 33 cm x 3.8 cm	4.3 kg	6
FG9S0925	YEL	Stable Safety Sign with International Wet Floor Symbol	Open: 26" l x 13" w x 13¼" d Closed: 32¼" l x 13" w x 1½" d	9.5 lb	Open: 66 cm x 33 cm x 33.6 cm Closed: 81.9 cm x 33 cm x 3.8 cm	4.3 kg	6

Hanging Safety Sign

An essential safety sign for use in stairways and doors.

- Flexible locking hanger keeps sign in place
- Two-sided design meets OSHA requirements
- ANSI- and OSHA-compliant color and graphics**



NO.	COLOR	DESCRIPTION	U.S. DIMENSIONS	U.S. SHIP WT/CTN	METRIC DIMENSIONS	METRIC SHIP WT/CTN	PACK
FG611000*	YEL	Hanging Safety Sign with Multilingual "Caution" Imprint and Falling Person Symbol	19.5" l x 4.375" w	3.0 lb	49.53 cm x 11.1 cm	1.4 kg	6

*Custom imprinting available; contact Rubbermaid Customer Service for details.

**ANSI Z535.3—2002 Criteria for Safety Symbols; ANSI Z535—Safety Color; OSHA 1910.144—Safety Color; OSHA 1910.145—Specification for Accident Prevention Signage

UTILITY REFUSE AND RECYCLING

DECORATIVE REFUSE

SAFETY

MATERIAL HANDLING

WASHROOM

FOODSERVICE

ACCESSORIES & INDEX

Floor Safety Signs

Lightweight, versatile signs for effective safety communication.

- “Closed” and “Caution” warning messages imprinted in English, French, and Spanish
- Folds for convenient storage and transport on janitorial carts or Rim Caddy (FG9W8700)
- Two- and four-sided models available
- ANSI- and OSHA-compliant color* and graphics**



NO.	COLOR	DESCRIPTION	U.S. DIMENSIONS	U.S. SHIP WT/CTN	METRIC DIMENSIONS	METRIC SHIP WT/CTN	PACK
FG611200***	YEL	Floor Sign with Multilingual “Caution” Imprint, 2-Sided	Open: 26" l x 11" w x 25" h Closed: 26" l x 11" w	15.0 lb	Open: 66 cm x 27.9 cm x 63.5 cm Closed: 66 cm x 27.9 cm	6.8 kg	6
1867505*	BLACK	Executive Multilingual Caution Sign, 2-Sided, Black	Open: 26" l x 11" w x 25" h Closed: 26" l x 11" w	15.0 lb	Open: 66 cm x 27.9 cm x 63.5 cm Closed: 66 cm x 27.9 cm	6.8 kg	6
1867506*	GRAY	Executive Multilingual Caution Sign, 2-Sided, Gray	Open: 26" l x 11" w x 25" h Closed: 26" l x 11" w	15.0 lb	Open: 66 cm x 27.9 cm x 63.5 cm Closed: 66 cm x 27.9 cm	6.8 kg	6
FG611277	YEL	Floor Sign with “Caution Wet Floor” Imprint, 2-Sided	Open: 26" l x 11" w x 25" h Closed: 26" l x 11" w	15.0 lb	Open: 66 cm x 27.9 cm x 63.5 cm Closed: 66 cm x 27.9 cm	6.8 kg	6
FG611278	YEL	Floor Sign with Multilingual “Closed” Imprint, 2-sided	Open: 26" l x 11" w x 25" h Closed: 26" l x 11" w	15.0 lb	Open: 66 cm x 27.9 cm x 63.5 cm Closed: 66 cm x 27.9 cm	6.8 kg	6
FG611400	YEL	Floor Sign with Multilingual “Caution” Imprint, 4-Sided	Open: 38" l x 12" w x 37" h Closed: 38" l x 12" w	26.9 lb	Open: 96.5 cm x 30.5 cm x 94 cm Closed: 96.5 cm x 30.5 cm	12.2 kg	6
1867509*	BLACK	Executive Multilingual Caution Sign, 4-Sided, Black	Open: 38" l x 12" w x 37" h Closed: 38" l x 12" w	26.9 lb	Open: 96.5 cm x 30.5 cm x 94 cm Closed: 96.5 cm x 30.5 cm	12.2 kg	6
FG611477	YEL	Floor Sign with “Caution Wet Floor” Imprint, 4-Sided	Open: 38" l x 12" w x 37" h Closed: 38" l x 12" w	26.9 lb	Open: 96.5 cm x 30.5 cm x 94 cm Closed: 96.5 cm x 30.5 cm	12.2 kg	6
FG618400	YEL	20' (6.1 m) Barrier Chain for FG611400 and Safety Cones	0.25" dia x 20' l x 0.88" w	5.2 lb	0.6 cm dia x 50.8 cm x 2.2 cm	2.4 kg	4

*Applies to yellow signs only. Executive Series™ gray and black Caution Signs are NOT compliant with OSHA nor ANSI color or graphics. FG611278 and FG611478 are NOT compliant with OSHA nor ANSI graphics.

**ANSI Z535.3–2002 Criteria for Safety Symbols; ANSI Z535–Safety Color; OSHA 1910.144–Safety Color; OSHA 1910.145–Specification for Accident Prevention Signage.

***Custom imprinting available; contact Rubbermaid Customer Service for details.

Executive Wooden Multilingual Caution Signs

2-sided hinged Caution signs.

- Elegant dark hardwood frame
- Durable plastic feet help protect wood finish from spills
- Hinged top with integrated carry handle for easy transport and storage
- Available in gold or silver
- Trilingual Caution plate



NO.	COLOR	DESCRIPTION	U.S. DIMENSIONS	U.S. SHIP WT/CTN	METRIC DIMENSIONS	METRIC SHIP WT/CTN	PACK
1867507	GOLD	Executive Wooden Multilingual Caution Sign, 2-Sided, Gold	Open: 22" l x 15½" w x 20" d Closed: 23¾" l x 15½" w x 2¼" d	13.5 lb	Open: 55.9 cm x 38.4 cm x 50.8 cm Closed: 60.3 cm x 38.4 cm x 5.7 cm	6.2 kg	1
1867508	SILVER	Executive Wooden Multilingual Caution Sign, 2-Sided, Silver	Open: 22" l x 15½" w x 20" d Closed: 23¾" l x 15½" w x 2¼" d	13.5 lb	Open: 55.9 cm x 38.4 cm x 50.8 cm Closed: 60.3 cm x 38.4 cm x 5.7 cm	6.2 kg	1

Site Safety Hanging Signs

Sign and pole combination for blocking doorways and entrances.

- Twisting action secures pole in doorways up to 50" wide to prohibit entry
- Soft, pliable sign rolls around pole for easy storage
- ANSI- and OSHA-compliant color



NO.	COLOR	DESCRIPTION	U.S. DIMENSIONS	U.S. SHIP WT/CTN	METRIC DIMENSIONS	METRIC SHIP WT/CTN	PACK
FG9S1500	YEL	Site Safety Hanging Sign with “Closed for Cleaning” Imprint – English Only	Closed: 13" h x 28" w x 1" d Open: 13" h x 50½" w x 1" d	5.5 lb	33 cm x 71.12 cm x 2.5 cm 33 cm x 127.6 cm x 2.5 cm	2.5 kg	6
FG9S1600	YEL	Site Safety Hanging Sign with Multilingual “Closed for Cleaning” Imprint	Closed: 13" h x 27¾" w x 1" d Open: 13" h x 50" w x 1" d	5.5 lb	33 cm x 70.5 cm x 2.5 cm 33 cm x 127 cm x 2.5 cm	2.5 kg	6

Folding Safety Cones

Large cone folds with a simple twist and slides into compact shell for handy storage.

- Made of spring steel and durable, easy-clean fabric
- Highly visible—30% more surface area than competitive fabric safety cones
- Large when deployed; compact when folded and stored in shell
- Storage shell mounting hardware includes tape, strap, and screws
- ANSI- and OSHA-compliant color* and graphics**

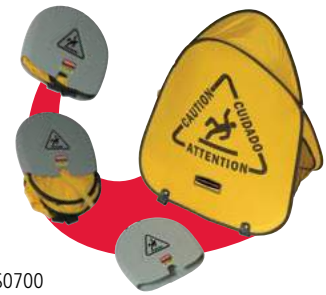

FG9S0700

NO.	COLOR	DESCRIPTION	U.S. DIMENSIONS	U.S. SHIP WT/CTN	METRIC DIMENSIONS	METRIC SHIP WT/CTN	PACK
FG9S0700	YEL	Folding Safety Cone with "Caution" Imprint, English, Spanish, French	Opened: 20" h x 18 3/4" w x 13" d Closed: 8" h x 8" w x 1 1/2" d Shell: 9" h x 8 3/4" w x 1 3/4" d	16.5 lb	Opened: 50.8 cm x 46.6 cm x 33.0 cm Closed: 20.3 cm x 20.3 cm x 3.81 cm Shell: 22.9 cm x 22.2 cm x 4.44 cm	7.5 kg	12
FG9S0725	YEL	Folding Safety Cone with International Wet Floor Symbol	Opened: 20" h x 18 3/4" w x 13" d Closed: 8" h x 8" w x 1 1/2" d Shell: 9" h x 8 3/4" w x 1 3/4" d	16.5 lb	Opened: 50.8 cm x 46.6 cm x 33.0 cm Closed: 20.3 cm x 20.3 cm x 3.81 cm Shell: 22.9 cm x 22.2 cm x 4.44 cm	7.5 kg	12

Pop-Up Safety Cones

Collapsible, automatically deployable cone.

- Durable cone material withstands rough handling
- Wall-mounted, shatterproof storage tube provides easy and compact storage
- Storage tube mounting hardware includes tape and screws
- ANSI- and OSHA-compliant color* and graphics**



FG9S0000

NO.	COLOR	DESCRIPTION	U.S. DIMENSIONS	U.S. SHIP WT/CTN	METRIC DIMENSIONS	METRIC SHIP WT/CTN	PACK
FG9S0000	YEL	Pop-Up Safety Cone, 20" (50.8 cm) with Multilingual "Caution" Imprint and Wet Floor Symbol	21" dia x 21" w x 20" h	12.7 lb	53.3 cm dia x 53.3 cm x 50.8 cm	5.8 kg	12
FG9S0100	YEL	Pop-Up Safety Cone, 30" (76.2 cm) with Multilingual "Caution" Imprint and Wet Floor Symbol	21" dia x 21" w x 30" h	23.5 lb	53.3 cm dia x 53.3 cm x 76.2 cm	10.7 kg	12

Safety Cones and Accessories

Highly visible, bright yellow hazard protection system.

- Versatile top design accommodates barricade belt, flashing light, lock-in sign holder, and Audio Guard® accessories
- Four-sided shape for efficient stacking
- Multilingual imprinted warning messages provide effective communication with broad audiences
- Molded-in slots for easy handling
- Can be used with BRUTE® Square Dolly (FG353000) for easy transport
- ANSI- and OSHA-compliant color*



NO.	COLOR	DESCRIPTION	U.S. DIMENSIONS	U.S. SHIP WT/CTN	METRIC DIMENSIONS	METRIC SHIP WT/CTN	PACK
FG353000	BLA	BRUTE® Square Dolly	17.25" sq x 6.25" h	18.5 lb	43.8 cm sq x 15.9 cm	8.4 kg	2
FG618400	YEL	20" (50.8 cm) Barrier Chain for G611400 and Safety Cones	0.25" dia x 20" l x 0.88" w	5.2 lb	0.6 cm dia x 50.8 cm x 2.2 cm	2.4 kg	4
FG627600***	YEL	Safety Cone 36" (91.4 cm) with Multilingual "Caution" Imprint	12.25" l x 12.25" w x 36" h	17.6 lb	31.1 cm x 31.1 cm x 91.4 cm	8 kg	5
FG627677	YEL	Safety Cone 36" (91.4 cm) with Multilingual "Caution Wet Floor" Imprint	12.25" l x 12.25" w x 36" h	17.6 lb	31.1 cm x 31.1 cm x 91.4 cm	8 kg	5
FG627687	YEL	Safety Cone 36" (91.4 cm) with Multilingual "Caution Safety First" Imprint	12.25" l x 12.25" w x 36" h	17.6 lb	31.1 cm x 31.1 cm x 91.4 cm	8 kg	5
FG627700***	YEL	Safety Cone 25.75" (65.4 cm) with Multilingual "Caution" Imprint	10.5" l x 10.5" w x 25.75" h	14.0 lb	26.7 cm x 26.7 cm x 65.4 cm	6.4 kg	6
FG627777	YEL	Safety Cone 25.75" (65.4 cm) with Multilingual "Caution Wet Floor" Imprint	10.5" l x 10.5" w x 25.75" h	14.0 lb	26.7 cm x 26.7 cm x 65.4 cm	6.4 kg	6
FG628400	BLA	Weight Ring – Single for all 36" (91.4 cm) Safety Cones	12.5" l x 12.5" w x 1" h	10.0 lb	31.8 cm x 31.8 cm x 2.5 cm	4.5 kg	1
FG628700	YEL	Cone Barricade System Consists of FG627600, (1) Belt Cassette, and (1) Double Weight Ring	12.25" l x 12.25" w x 39.75" h	27.2 lb	31.1 cm x 31.1 cm x 101 cm	12.3 kg	1

*Applies to yellow signs only.

**ANSI Z535.3–2002 Criteria for Safety Symbols; ANSI Z535–Safety Color; OSHA 1910.144–Safety Color; OSHA 1910.145–Specification for Accident Prevention Signage.

***Custom imprinting available; contact Rubbermaid Customer Service for details.

UTILITY REFUSE AND RECYCLING

DECORATIVE REFUSE

SAFETY

MATERIAL HANDLING

WASHROOM

FOODSERVICE

ACCESSORIES & INDEX

Mobile Barrier

Easy to use, highly visible mobile barrier for use in many situations.

- Flexible panels allow straight, curved, and circular configurations
- Extends to 13' when fully opened; locking straps keep barrier closed when not in use
- Lightweight and compact (2' x 13" footprint when closed)
- ANSI- and OSHA-compliant color
- For indoor use; shipped assembled



FG9S1100

Work around electrical equipment?

Excerpt from OSHA reg. 29 CFR 1910.335 (b)(2): "Barricades shall be used...to prevent or limit employee access to work areas...Conductive [metal] barricades may not be used where they might cause an electrical contact hazard."

NO.	COLOR	DESCRIPTION	U.S. DIMENSIONS	U.S. SHIP WT/CTN	METRIC DIMENSIONS	METRIC SHIP WT/CTN	PACK
FG9S1100	YEL	Mobile Barrier	Open: 40" h x 13' l x 1" w Closed: 40" h x 2' l x 13" w	37.0 lb	Open: 101.6 cm x 396 cm x 2.54 cm Closed: 101.6 cm x 61.0 cm x 33.0 cm	16.8 kg	1

Cone Barrier System

Complete, expandable system for quick deployment.

FG628700 includes:

- One 36" four-sided FG627600 Safety Cone
- One steel double weight ring (27.2 lbs)
- One belt cassette (7 ft x 3 in)
- ANSI- and OSHA-compliant color* and graphics**
- Expand the system with additional FG628700 units
- Stackable, can be used with BRUTE® Square Dolly (FG353000) for easy transport



FG628700 (2 qty.)

NO.	COLOR	DESCRIPTION	U.S. DIMENSIONS	U.S. SHIP WT/CTN	METRIC DIMENSIONS	METRIC SHIP WT/CTN	PACK
FG353000	BLA	BRUTE® Square Dolly	17.25" sq x 6.25" h	18.5 lb	43.8 cm sq x 15.9 cm	8.4 kg	2
FG628700	YEL	Cone Barricade System Consists of FG627600, (1) Belt Cassette, and (1) Double Weight Ring	12.25" l x 12.25" w x 39.75" h	27.2 lb	31.1 cm x 31.1 cm x 101 cm	12.3 kg	1

Over-the-Spill® System

Slip-resistant pads quickly cover spills and alert pedestrians.

- Each yellow pad is coded with universal caution symbol and "Caution Wet Floor" message in English and Spanish
- Dispensing station mounts on flat surfaces
- Pads absorb up to 14oz of liquid for faster cleanup



FG425100



FG425500



FG425400



FG425400 on FG611200

NO.	COLOR	DESCRIPTION	U.S. DIMENSIONS	U.S. SHIP WT/CTN	METRIC DIMENSIONS	METRIC SHIP WT/CTN	PACK
FG425100	YEL	Over-the-Spill® Station Kit includes Pad Dispenser, 22 Large Pads, and Fasteners	21" l x 17.75" w	14.0 lb	53.3 cm x 45.1 cm	6.4 kg	6
FG425200	YEL	Over-the-Spill® Station Pads, Large; Refill Pads for FG425100, Contains 22 Pads	20" l x 16.5" w	25.0 lb	50.8 cm x 41.9 cm	11.3 kg	12
FG425300	YEL	Over-the-Spill® Station Pads, Medium; Refill Pads for FG425100, Contains 22 Pads	16.5" l x 14" w	17.0 lb	41.9 cm x 35.6 cm	7.7 kg	12
FG425400	YEL	Over-the-Spill® Pad Tablet, Contains 22 Pads	16.5" l x 14" w	20.0 lb	41.9 cm x 35.6 cm	9.1 kg	12
FG425500	YEL	Over-the-Spill® Mini Tablet, Contains 22 Pads	17" l x 7" w x 1.25" h	8.7 lb	43.2 cm x 17.8 cm x 3.2 cm	3.9 kg	12

*Applies to yellow signs only.

**ANSI Z535.3–2002 Criteria for Safety Symbols; ANSI Z535–Safety Color; OSHA 1910.144–Safety Color; OSHA 1910.145–Specification for Accident Prevention Signage.

Spill Mop

- 10-pack dispensing carton is compact enough to fit easily in most spaces
- Each pad is made with highly absorbent material designed for quickly removing liquid, water-based spills
- Absorbed liquid is turned to gel, trapping it inside to prevent leaks and drips
- Each pad holds up to 32 ounces of water
- For use with 2017061 Spill Mop Handle.
- Up to two packs can fit neatly in 2017162 Spill Mop Storage Cabinet for convenient access



2017059



2017061



2017162



2031093

ITEM #	DESCRIPTION	COLOR	COLLAPSED LENGTH	EXTENDED LENGTH	WIDTH	HEIGHT	DEPTH	PACK
2017059	Spill Mop Pads 10 ct	GRAY	N/A	N/A	7.30"	10.00"	3.34"	10
2017061	Spill Mop Handle	YELLOW	22.18"	47.54"	3.99"	N/A	N/A	12
2017162	Spill Mop Storage Cabinet	GRAY	N/A	N/A	13.27"	24.60"	4.00"	1
2031093	Spill Mop Kit*	GRAY	N/A	N/A	13.27"	24.60"	4.00"	1

*Includes: 1 Spill Mop Pads 10 ct, 1 Spill Mop Handle, and 1 Spill Mop Storage Cabinet

Biohazard Spill Mop

- 10 pack dispensing carton is compact enough to fit easily in most spaces
- Each pad is made with highly absorbent material designed for quickly removing liquid biohazard spills.
- Absorbed liquid is turned to gel, trapping it inside to prevent leaks and drips
- Each pad holds up to 32 ounces of water and 13.5 ounces of NaCl 0.9%
- For use with 2017061 Spill Mop Handle.
- Up to two packs can fit neatly in 2017162 Spill Mop Storage Cabinet for convenient access



2017060



2017061



2017162



2031094

ITEM #	DESCRIPTION	COLOR	COLLAPSED LENGTH	EXTENDED LENGTH	WIDTH	HEIGHT	DEPTH	PACK
2017060	Biohazard Spill Mop Pads 10 ct	GRAY	N/A	N/A	7.30"	10.00"	3.34"	10
2017061	Spill Mop Handle	YELLOW	22.18"	47.54"	3.99"	N/A	N/A	12
2017162	Spill Mop Storage Cabinet	GRAY	N/A	N/A	13.27"	24.60"	4.00"	1
2031094	Biohazard Spill Mop Kit*	GRAY	N/A	N/A	13.27"	24.60"	4.00"	1

*Includes: 1 Biohazard Spill Mop Pads 10 ct, 1 Spill Mop Handle, and 1 Spill Mop Storage Cabinet



Rubbermaid
Commercial Products

USAGE INSTRUCTIONS

1. Insert the mop handle into the top of the mop head.
2. Push the mop handle down until it is fully seated.
3. Press the handle up until it is fully seated.
4. Push the mop head down until it is fully seated.
5. Push the mop handle down until it is fully seated.
6. Push the mop head up until it is fully seated.

REFILL SKU#

SPILL MOP HANDLE (100) | SPILL MOP PADS (100) | HAZARD SPILL MOP PADS (100) | SPILL MOP HANDLE (100)

rubbermaidcommercial.com | 800.347.7000

Rubbermaid
Commercial Products

HAZARD SPILL MOP PADS
Safe to Disinfect your Area with Single-Use Mop Pads

MINIMIZE CONTACT
Avoids and reduces your contact with hazardous materials.

SAFELY REMOVE LIQUID BIOHAZARD SPILLS
Removes up to 13.5 oz. of liquid biohazard spills.

10 COUNT

FOR BLOOD AND BODILY FLUIDS

HAZARD SPILL MOP PADS

FOR BLOOD AND BODILY FLUIDS

UTILITY REFUSE
AND RECYCLING

DECORATIVE REFUSE

SAFETY

MATERIAL HANDLING

WASHROOM

FOODSERVICE

ACCESSORIES
& INDEX

UTILITY REFUSE
AND RECYCLING



MATERIAL HANDLING

DECORATIVE REFUSE

CLEANING

MATERIAL HANDLING

WASHROOM

FOODSERVICE

ACCESSORIES
& INDEX

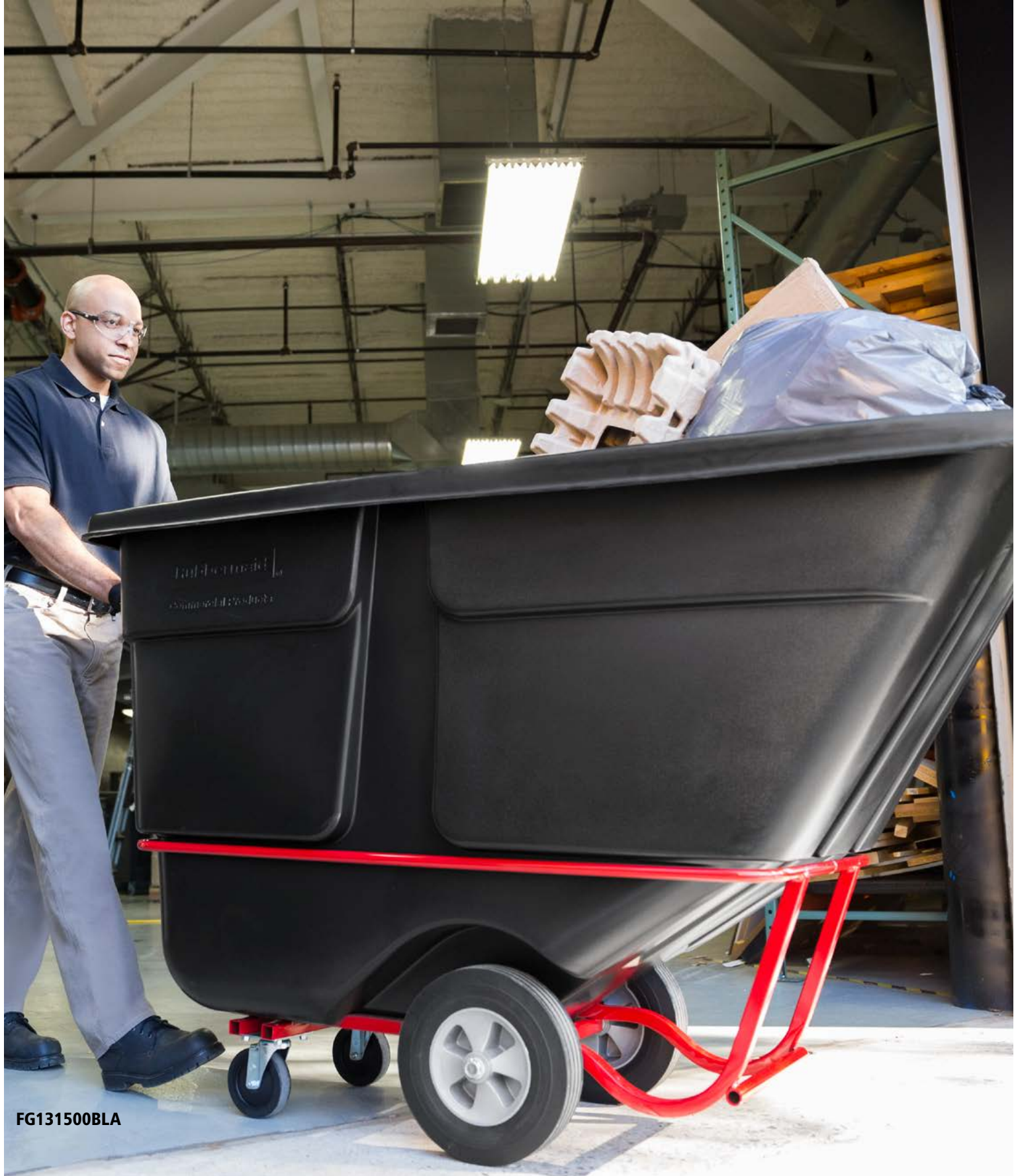

FG131500BLA



FG9T6800BLA

MATERIAL HANDLING

BULK COLLECTION

Structural Foam Tilt Trucks 164
 Rotomolded Tilt Trucks.....165
 Heavy-Duty Tilt Trucks..... 166
 Heavy-Duty Tilt Truck Lids..... 166
 Self-Dumping Hoppers..... 167
 Mega BRUTE® Mobile Collectors 167
 Cube Trucks 168
 Collapsible X-Carts..... 169

UTILITY CARTS

Heavy-Duty Adaptable Cart 171
 Heavy-Duty Utility Carts..... 172
 Trades Carts..... 174
 5-Drawer Mobile Work Center..... 174
 TradeMaster® Mobile Cabinets
 and Work Centers..... 175
 Convertible Utility Cart..... 175
 Executive Series™ Service Cart 176
 Service Carts..... 177
 Xtra™ Carts..... 177

PLATFORM TRUCKS

Heavy-Duty Platform Trucks 179
 Sheet and Panel Trucks and
 A-Frame Panel Trucks..... 180
 Side-Panel Platform Trucks 181

CASTERS TO MEET YOUR NEEDS

Casters to Meet Your Needs..... 182

CART ACCESSORIES

Cart Accessories..... 183

OUTDOOR HANDLING AND STORAGE

Stock Tanks..... 185
 Big Wheel® Carts 186
 Heavy-Duty Big Wheel® Cart..... 186
 Utility Lawn Carts 186

STORAGE

BRUTE® Totes..... 187
 Stack and Nest Palletote® Boxes 187



UTILITY REFUSE
AND RECYCLING

DECORATIVE REFUSE

CLEANING

MATERIAL HANDLING

WASHROOM

FOODSERVICE

ACCESSORIES
& INDEX

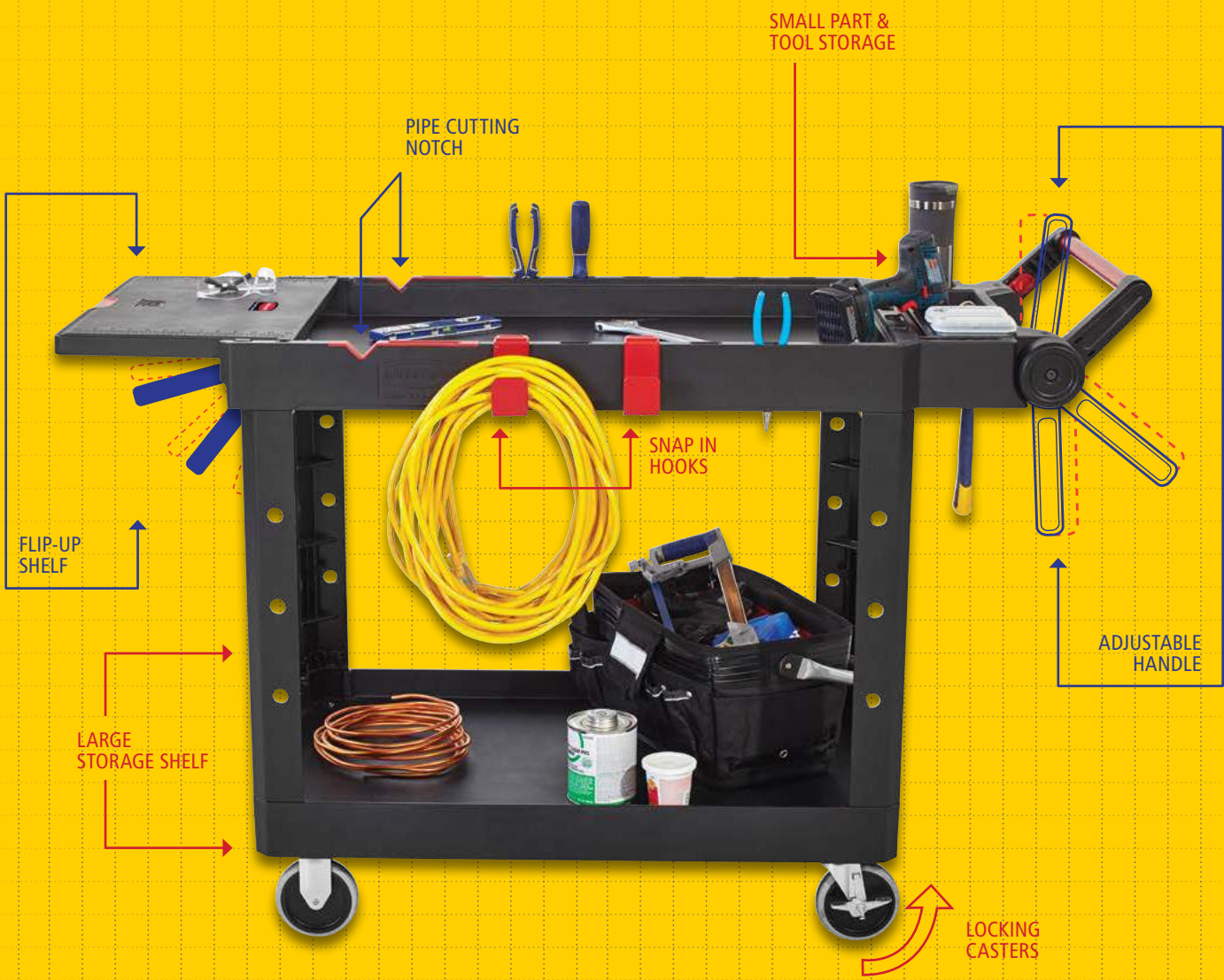

HEAVY-DUTY ADAPTABLE CART

HANDLES ANY JOB



ADJUSTS TO 4 POSITIONS

Variety of positions to accommodate users of all heights for improved control and comfort.



FLIP-UP SHELF

Eliminates the need to clear top shelf contents for work space. Perfect for laptop use or small part assembly.



CONVERTIBLE TOP SHELF

Supports 1/2" piece of plywood to adapt top shelf into flat work surface for larger items and tasks.



SLOTS AROUND RIM

Accommodate small hand tools like wrenches, pliers, or screwdrivers for quick, easy access.



SMALL PART AND TOOL STORAGE

Keep hardware and tools organized for quick retrieval. Tablet and cup holder also included.

UTILITY REFUSE
AND RECYCLING

DECORATIVE REFUSE

CLEANING

MATERIAL HANDLING

WASHROOM

FOODSERVICE

ACCESSORIES
& INDEX

Structural Foam Tilt Trucks

Durable molded trucks handle heavy loads with ease.

- Ergonomic handles for better handling and steering
- Frameless design supports USDA Meat and Poultry Equipment Compliance
- Unibody design promotes a more discreet appearance in public areas
- Fits through standard commercial doorways and onto elevators easily
- Optional domed lid available



FG101100



The ergonomically designed "steering wheel" handle provides excellent handling and maneuvering.



Inset wheel position prevents damage to surroundings.



FG102800

1/2-Cubic-Yard Tilt Trucks

NO.	COLOR	DESCRIPTION	U.S. DIMENSIONS	U.S. SIZE	U.S. CAPACITY	U.S. SHIP WT/CTN	METRIC DIMENSIONS	METRIC SIZE	METRIC CAPACITY	METRIC SHIP WT/CTN	PACK
FG9T1300	BLA	Structural Foam Tilt Truck, Utility-Duty	57.38" l x 26.88" w x 33.88" h	1/2 cu yd	450 lb	86.9 lb	145.7 cm x 68.3 cm x 86.1 cm	0.4 m ³	204.1 kg	39.4 kg	1
FG9T1400	BLA	Structural Foam Tilt Truck, Standard-Duty	57.38" l x 26.88" w x 33.88" h	1/2 cu yd	850 lb	95.9 lb	145.7 cm x 68.3 cm x 86.1 cm	0.4 m ³	385.6 kg	43.5 kg	1
FG9T2200	BLA	Lid for 1/2-Cubic-Yard Tilt Trucks	52" l x 27.88" w x 9" h	N/A	N/A	25.3 lb	132.1 cm x 70.8 cm x 22.9 cm	N/A	N/A	11.5 kg	1

3/4-Cubic-Yard Tilt Trucks

NO.	COLOR	DESCRIPTION	U.S. DIMENSIONS	U.S. SIZE	U.S. CAPACITY	U.S. SHIP WT/CTN	METRIC DIMENSIONS	METRIC SIZE	METRIC CAPACITY	METRIC SHIP WT/CTN	PACK
FG101100	BLA	Structural Foam Tilt Truck, Utility-Duty	64.5" l x 30.25" w x 38" h	3/4 cu yd	600 lb	92.0 lb	163.8 cm x 76.8 cm x 96.5 cm	.6 m ³	272.1 kg	41.7 kg	1
FG101300	BLA	Structural Foam Tilt Truck, Standard-Duty	64.5" l x 30.25" w x 38" h	3/4 cu yd	1,000 lb	101.0 lb	163.8 cm x 76.8 cm x 96.5 cm	.6 m ³	453.6 kg	45.8 kg	1
FG102800	BLA	Lid for 3/4-Cubic-Yard Tilt Trucks	61" l x 31.75" w x 8.75" h	N/A	N/A	24.8 lb	154.9 cm x 80.6 cm x 22.2 cm	N/A	N/A	11.2 kg	1

1-Cubic-Yard Tilt Trucks

NO.	COLOR	DESCRIPTION	U.S. DIMENSIONS	U.S. SIZE	U.S. CAPACITY	U.S. SHIP WT/CTN	METRIC DIMENSIONS	METRIC SIZE	METRIC CAPACITY	METRIC SHIP WT/CTN	PACK
FG9T1500	BLA	Structural Foam Tilt Truck, Standard-Duty	70.75" l x 33.5" w x 42.25" h	1 cu yd	1,250 lb	139.1 lb	179.7 cm x 85.1 cm x 107.3 cm	.8 m ³	566.9 kg	63.1 kg	1
FG9T1600	BLA	Structural Foam Tilt Truck, Heavy-Duty	70.75" l x 33.5" w x 42.25" h	1 cu yd	2,100 lb	141.1 lb	179.7 cm x 85.1 cm x 107.3 cm	.8 m ³	952.5 kg	64.0 kg	1
FG9T2300	BLA	Lid for 1-Cubic-Yard Tilt Trucks	66.88" l x 34.5" w x 9" h	N/A	N/A	36.6 lb	169.9 cm x 87.6 cm x 22.9 cm	N/A	N/A	16.6 kg	1

Rotomolded Tilt Trucks

Durable rotational molded trucks handle heavy loads with ease.

- Easy to handle and maneuver
- Inset wheels protect walls and fixtures



FG130573



FG131400BLA

1/2-Cubic-Yard Tilt Trucks

NO.	COLOR	DESCRIPTION	U.S. DIMENSIONS	U.S. SIZE	U.S. CAPACITY	U.S. SHIP WT/CTN	METRIC DIMENSIONS	METRIC SIZE	METRIC CAPACITY	METRIC SHIP WT/CTN	PACK
FG9T1700	BLA	Tilt Truck (RM)	56.75" l x 28" w x 38.63" h	1/2 cu yd	300 lb	138.5 lb	144.1 cm x 71.1 cm x 98.1 cm	0.4 m ³	136.1 kg	62.8 kg	3
FG130400	BLA	Tilt Truck, Utility-Duty (RM)	56.75" l x 28" w x 38.63" h	1/2 cu yd	450 lb	62.5 lb	144.1 cm x 71.1 cm x 98.1 cm	0.4 m ³	204.1 kg	28.3 kg	1
FG130500	YEL, RED, DBLUE, BLA	Tilt Truck, Standard-Duty (RM)	60.5" l x 28" w x 38.63" h	1/2 cu yd	850 lb	77.0 lb	153.7 cm x 71.1 cm x 98.1 cm	0.4 m ³	385.6 kg	34.9 kg	1
FG130573	BLUE	Recycling Tilt Truck, Standard-Duty (RM)	60.5" l x 28" w x 38.63" h	1/2 cu yd	850 lb	77.0 lb	153.7 cm x 71.1 cm x 98.1 cm	0.4 m ³	385.6 kg	34.9 kg	1
FG130600*	BLA	Tilt Truck, Heavy-Duty (RM)	60.5" l x 28" w x 38.63" h	1/2 cu yd	1,400 lb	88.0 lb	153.7 cm x 71.1 cm x 98.1 cm	0.4 m ³	635.0 kg	39.9 kg	1
FG130700*	BLA	Lid for 1/2 Cubic Yard Tilt Trucks	56.5" l x 28.5" w x 9" h	N/A	N/A	22.3 lb	143.5 cm x 72.4 cm x 22.9 cm	N/A	N/A	10.1 kg	1

1-Cubic-Yard Tilt Trucks

NO.	COLOR	DESCRIPTION	U.S. DIMENSIONS	U.S. SIZE	U.S. CAPACITY	U.S. SHIP WT/CTN	METRIC DIMENSIONS	METRIC SIZE	METRIC CAPACITY	METRIC SHIP WT/CTN	PACK
FG9T1800	BLA	Tilt Truck	72.25" l x 33.5" w x 43.75" h	1 cu yd	600 lb	259.5 lb	183.5 cm x 85.1 cm x 111.1 cm	0.8 m ³	272.1 kg	117.7 kg	3
FG131400	BLA	Tilt Truck, Utility-Duty (RM)	72.25" l x 33.5" w x 43.75" h	1 cu yd	850 lb	111.0 lb	183.5 cm x 85.1 cm x 111.1 cm	0.8 m ³	385.6 kg	50.3 kg	1
FG131500	YEL, RED, DBLUE, BLA	Tilt Truck, Standard-Duty (RM)	72.25" l x 33.5" w x 43.75" h	1 cu yd	1,250 lb	111.0 lb	183.5 cm x 85.1 cm x 111.1 cm	0.8 m ³	567.0 kg	50.3 kg	1
2089826	BLUE	Recycling Tilt Truck, Standard-Duty (RM)	72.25" l x 33.5" w x 43.75" h	1 cu yd	1,250 lb	111.0 lb	183.5 cm x 85.1 cm x 111.1 cm	0.8 m ³	567.0 kg	50.3 kg	1
FG131600	BLA	Tilt Truck, Heavy-Duty (RM)	72.25" l x 33.5" w x 43.75" h	1 cu yd	2,100 lb	120.0 lb	183.5 cm x 85.1 cm x 111.1 cm	0.8 m ³	952.5 kg	54.4 kg	1
FG131700*	BLA	Lid for 1 Cubic Yard Tilt Trucks	69.5" l x 34" w x 8.5" h	N/A	N/A	24.0 lb	176.5 cm x 86.4 cm x 21.6 cm	N/A	N/A	10.9 kg	1

1 1/2-Cubic-Yard Tilt Trucks

NO.	COLOR	DESCRIPTION	U.S. DIMENSIONS	U.S. SIZE	U.S. CAPACITY	U.S. SHIP WT/CTN	METRIC DIMENSIONS	METRIC SIZE	METRIC CAPACITY	METRIC SHIP WT/CTN	PACK
FG102500*	BLA	Tilt Truck, Standard-Duty (RM)	80.5" l x 43" w x 49.5" h	1 1/2 cu yd	1,200 lb	212.0 lb	204.5 cm x 109.2 cm x 125.7 cm	1.1 m ³	544.3 kg	96.2 kg	1
FG102600*	BLA	Tilt Truck, Heavy-Duty (RM)	80.5" l x 43" w x 49.5" h	1 1/2 cu yd	2,100 lb	213.0 lb	204.5 cm x 109.2 cm x 125.7 cm	1.1 m ³	952.5 kg	96.6 kg	1
FG102700	BLA	Lid for 1 1/2 Cubic Yard Tilt Trucks	82.9" l x 44.5" w x 3" h	N/A	N/A	32.8 lb	210.5 cm x 113 cm x 7.6 cm	N/A	N/A	11.5 kg	1

2-Cubic-Yard Tilt Trucks

NO.	COLOR	DESCRIPTION	U.S. DIMENSIONS	U.S. SIZE	U.S. CAPACITY	U.S. SHIP WT/CTN	METRIC DIMENSIONS	METRIC SIZE	METRIC CAPACITY	METRIC SHIP WT/CTN	PACK
FG103500*	BLA	Tilt Truck, Standard-Duty (RM)	81.25" l x 46.75" w x 50" h	2 cu yd	1,900 lb	215.0 lb	206.4 cm x 118.7 cm x 127 cm	1.5 m ³	861.8 kg	97.5 kg	1
FG103600*	BLA	Tilt Truck, Heavy-Duty (RM)	81.25" l x 46.75" w x 50" h	2 cu yd	2,300 lb	238.5 lb	206.4 cm x 118.7 cm x 127 cm	1.5 m ³	1043.3 kg	108.2 kg	1

2 1/2-Cubic-Yard Tilt Trucks

NO.	COLOR	DESCRIPTION	U.S. DIMENSIONS	U.S. SIZE	U.S. CAPACITY	U.S. SHIP WT/CTN	METRIC DIMENSIONS	METRIC SIZE	METRIC CAPACITY	METRIC SHIP WT/CTN	PACK
FG104500*	BLA	Tilt Truck, Standard-Duty (RM)	81.5" l x 55.5" w x 50" h	2 1/2 cu yd	1,900 lb	233.5 lb	207 cm x 141 cm x 127 cm	1.9 m ³	861.8 kg	105.9 kg	1
FG104600*	BLA	Tilt Truck, Heavy-Duty (RM)	81.5" l x 55.5" w x 50" h	2 1/2 cu yd	2,300 lb	231.4 lb	207 cm x 141 cm x 127 cm	1.9 m ³	1043.3 kg	105.0 kg	1

*Requires up to 3 weeks lead time and is not returnable.

*Custom colors available; contact Rubbermaid Customer Service for details.

*Pneumatic Wheels RM = Rotational Molded



Heavy-Duty Tilt Trucks

Towable and trainable tilt trucks for heavy-duty use.

- Heavy-duty tow bar, hitch, and frame for multiple truck towing and training up to 5MPH
- Pneumatic wheels provide smooth movement over rough terrain
- Available in 1/2, 1, and 1 1/2 cu yd sizes



FG131641
Towable/Trainable
Tilt Truck



FG131542BLA

1/2-Cubic-Yard Tilt Trucks

NO.	COLOR	DESCRIPTION	U.S. DIMENSIONS	U.S. SIZE	U.S. CAPACITY	U.S. SHIP WT/CTN	METRIC DIMENSIONS	METRIC SIZE	METRIC CAPACITY	METRIC SHIP WT/CTN	PACK
FG130641*	BLA	Towable Trainable Tilt Truck, Heavy-Duty (RM)	64" l x 29" w x 40" h	1/2 cu yd	1,400 lb	92.2 lb	162.6 cm x 73.7 cm x 101.6 cm	0.4 m ³	635.0 kg	41.8 kg	1
FG130542	BLA	Forkliftable Tilt Truck, Standard Duty (RM)	60.5" l x 28" w x 38.63" h	1/2 cu yd	850 lb	77.0 lb	153.7 cm x 71.1 cm x 98.1 cm	0.4 m ³	385.6 kg	34.9 kg	1

1-Cubic-Yard Tilt Trucks

NO.	COLOR	DESCRIPTION	U.S. DIMENSIONS	U.S. SIZE	U.S. CAPACITY	U.S. SHIP WT/CTN	METRIC DIMENSIONS	METRIC SIZE	METRIC CAPACITY	METRIC SHIP WT/CTN	PACK
FG131641*	BLA	Towable Trainable Tilt Truck, Heavy-Duty (RM)	72.5" l x 33.5" w x 42.25" h	1 cu yd	2,100 lb	178.0 lb	184.2 cm x 85.1 cm x 107.3 cm	0.8 m ³	952.6 kg	80.7 kg	1
FG131542	BLA	Forkliftable Tilt Truck, Standard Duty (RM)	72.25" l x 33.5" w x 43.75" h	1 cu yd	1,250 lb	124.0 lb	183.5 cm x 85.1 cm x 111.1 cm	0.8 m ³	567.0 kg	56.2 kg	1

1 1/2-Cubic-Yard Tilt Trucks

NO.	COLOR	DESCRIPTION	U.S. DIMENSIONS	U.S. SIZE	U.S. CAPACITY	U.S. SHIP WT/CTN	METRIC DIMENSIONS	METRIC SIZE	METRIC CAPACITY	METRIC SHIP WT/CTN	PACK
FG102641*	BLA	Towable Trainable Tilt Truck, Heavy-Duty (RM)	92" l x 44" w x 51" h	1 1/2 cu yd	2,100 lb	232.0 lb	233.68 cm x 111.76 cm x 129.54 cm	1.14 m ³	952.6 kg	105.3 kg	1
FG102542	BLA	Forkliftable Tilt Truck, Standard-Duty (RM)	80.5" l x 43" w x 49.5" h	1 1/2 cu yd	1,500 lb	211.9 lb	204.47 cm x 109.22 cm x 125.73	1.14 m ³	680.3 kg	96.11 kg	1

*Pneumatic Wheels RM = Rotational Molded

Heavy-Duty Tilt Truck Lids

Domed, hinged lids provide convenient access to contents without reducing overall capacity.



FG102700

Heavy-Duty Tilt Truck Lids

NO.	COLOR	DESCRIPTION	U.S. DIMENSIONS	U.S. SIZE	U.S. CAPACITY	U.S. SHIP WT/CTN	METRIC DIMENSIONS	METRIC SIZE	METRIC CAPACITY	METRIC SHIP WT/CTN	PACK
FG130700	BLA	Lid for 1/2-Cubic-Yard Tilt Trucks	56.5" l x 28.5" w x 9" h	N/A	N/A	22.3 lb	143.5 cm x 72.4 cm x 22.9 cm	N/A	N/A	10.1 kg	1
FG131700	BLA	Lid for 1-Cubic-Yard Tilt Trucks	69.5" l x 34" w x 8.5" h	N/A	N/A	24.0 lb	176.5 cm x 86.4 cm x 21.6 cm	N/A	N/A	10.9 kg	1
FG102700	BLA	Lid for 1 1/2-Cubic-Yard Tilt Trucks	82.88" l x 44.5" w x 3" h	N/A	N/A	32.8 lb	210.5 cm x 113 cm x 7.6 cm	N/A	N/A	14.9 kg	1

Self-Dumping Hoppers

Large-capacity hoppers store and dump heavy loads with ease.

- Forklift-compatible for elevated dumping
- Tilts a full 30° below horizontal to ensure complete dumping
- Pull-release safety latch on .5- and 1-Cubic-Yard Hoppers and rotating latch release on 1.5- and 2-Cubic-Yard Hoppers prohibits premature dumping
- Resists rusting, denting, and pitting that can affect metal hoppers



½-Cubic-Yard Hoppers

NO.	COLOR	DESCRIPTION	U.S. DIMENSIONS	U.S. SIZE	U.S. CAPACITY	U.S. SHIP WT/CTN	METRIC DIMENSIONS	METRIC SIZE	METRIC CAPACITY	METRIC SHIP WT/CTN	PACK
FG105443	BLA	Self-Dumping Hopper with four 6" dia (15.2 cm) Polyolefin Casters	55" l x 26.25" w x 47.63" h	½ cu yd	750 lb	212.0 lb	139.7 cm x 66.7 cm x 121 cm	.4 m³	340.2 kg	96.2 kg	1

1-Cubic-Yard Hoppers

NO.	COLOR	DESCRIPTION	U.S. DIMENSIONS	U.S. SIZE	U.S. CAPACITY	U.S. SHIP WT/CTN	METRIC DIMENSIONS	METRIC SIZE	METRIC CAPACITY	METRIC SHIP WT/CTN	PACK
FG105943	BLA	Self-Dumping Hopper with four 6" dia (15.2 cm) Polyolefin Casters	71.5" l x 31.25" w x 52.5" h	1 cu yd	1,000 lb	247.0 lb	181.6 cm x 79.4 cm x 133.4 cm	.8 m³	453.6 kg	112.0 kg	1

2½-Cubic-Yard Hoppers

NO.	COLOR	DESCRIPTION	U.S. DIMENSIONS	U.S. SIZE	U.S. CAPACITY	U.S. SHIP WT/CTN	METRIC DIMENSIONS	METRIC SIZE	METRIC CAPACITY	METRIC SHIP WT/CTN	PACK
FG107443 ^A	BLA	Self-Dumping Hopper with four 6" dia (15.2 cm) Polyolefin Casters	83.5" l x 55" w x 56.63" h	2½ cu yd	1,000 lb	376.0 lb	212.1 cm x 139.7 cm x 143.8 cm	1.9 m³	453.6 kg	170.5 kg	1

^ARequires 3-week lead time and is not returnable.

Mega BRUTE® Mobile Collectors

The Mega BRUTE® Mobile Collector is a highly maneuverable and versatile waste and linen collection and sortation system. Innovative design delivers improved productivity and ease of use.

- High capacity—120-gallon/400-pound capacity
- Sortation options support recycling efforts
- Highly maneuverable; fits through a standard 36" doorway and travels easily on and off most elevators
- Rear doors ease handling of heavy filled liners



Optional lid (FG9W7200) fully covers contents; center hinge allows access to either end of Mega BRUTE® Mobile Collector.



Can liner retainer secures a 55-gallon can liner and flips up for easy access to storage area.



FG9W7300



SORTATION OPTIONS
Holds an optional 23-gallon Slim Jim® container for improved waste sortation and recycling.

EASILY MANEUVERABLE
Large 12" wheels and 5" nonmarking lockable casters in a diamond pattern allow Mega BRUTE® Mobile Collector to turn on its own axis.

STORAGE AREA
Ideal for storing extra can liners and other cleaning supplies.

NO.	COLOR	DESCRIPTION	U.S. DIMENSIONS	U.S. CAPACITY	U.S. SHIP WT/CTN	METRIC DIMENSIONS	METRIC CAPACITY	METRIC SHIP WT/CTN	PACK
FG9W7300	BLA	Executive Mega BRUTE® Mobile Collector – 1-Pack	52.5" l x 27.5" w x 42.5" h	120 gal	74.0 lb	133.4 cm x 69.9 cm x 108 cm	454.3 L	33.6 kg	1
FG9W7200	BLA	Executive Mega BRUTE® Mobile Collector Lid	49.5" l x 30" w x 10.5" h	N/A	12.4 lb	125.7 cm x 76.2 cm x 26.7 cm	N/A	5.6 kg	1

Cube Trucks

A complete line of trucks for waste collection, material transport, and laundry handling, with the durability of Rotational Molding technology.

- Towable trainable model offers corner casters
- Spring platform option elevates contents for easier loading and unloading
- Heavy-duty utility models include metal body support band



FG461673

FG461200 / FG461300

8-Cubic-Foot (6.4 Bushel)

NO.	COLOR	DESCRIPTION	U.S. DIMENSIONS	U.S. BUSHEL (BU)	U.S. SIZE	U.S. CAPACITY	U.S. SHIP WT/CTN	METRIC DIMENSIONS	METRIC SIZE	METRIC CAPACITY	METRIC SHIP WT/CTN	PACK
FG460800	BLA	Cube Truck	38" l x 26" w x 28.13" h	6.4	8 cu ft	300 lb	36.0 lb	96.5 cm x 66 cm x 71.5 cm	.2 m ³	136.1 kg	16.3 kg	1
FG470800	BLA	Utility Truck, Heavy-Duty with 4" dia (10.2 cm) Casters	38.38" l x 26" w x 28.25" h	6.4	8 cu ft	700 lb	48.0 lb	97.5 cm x 66 cm x 71.8 cm	.2 m ³	317.5 kg	21.8 kg	1
FG460900 ^a	BLA	Lid for 8 ft. ³ Cube Trucks	38.38" l x 25.75" w x 8.5" h	N/A	N/A	N/A	13.5 lb	97.5 cm x 65.4 cm x 21.6 cm	N/A	N/A	6.1 kg	1

12-Cubic-Foot (9.6 Bushel)

NO.	COLOR	DESCRIPTION	U.S. DIMENSIONS	U.S. BUSHEL (BU)	U.S. SIZE	U.S. CAPACITY	U.S. SHIP WT/CTN	METRIC DIMENSIONS	METRIC SIZE	METRIC CAPACITY	METRIC SHIP WT/CTN	PACK
FG461200	DBLUE, BLA	Cube Truck	42.75" l x 28" w x 33" h	9.6	12 cu ft	400 lb	40.0 lb	108.6 cm x 71.1 cm x 83.8 cm	.3 m ³	181.4 kg	18.1 kg	1
1867538	BLACK	Executive Cube Truck w/ Quiet Casters	42.75" l x 28" w x 33" h	9.6	12 cu ft	400 lb	40.0 lb	108.6 cm x 71.1 cm x 83.8 cm	.3 m ³	181.4 kg	18.1 kg	1
FG471200	BLA	Utility Truck, Heavy-Duty with 4" dia (10.2 cm) Casters	43.25" l x 28" w x 33.88" h	9.6	12 cu ft	800 lb	62.3 lb	109.9 cm x 71.1 cm x 86.1 cm	.3 m ³	362.9 kg	28.3 kg	1
FG461300 ^a	BLA	Lid for 12 ft. ³ Cube Trucks	43.13" l x 27.5" w x 8.5" h	N/A	N/A	N/A	15.1 lb	109.6 cm x 69.9 cm x 21.6 cm	N/A	N/A	6.8 kg	1

14-Cubic-Foot (11.3 Bushel)

NO.	COLOR	DESCRIPTION	U.S. DIMENSIONS	U.S. BUSHEL (BU)	U.S. SIZE	U.S. CAPACITY	U.S. SHIP WT/CTN	METRIC DIMENSIONS	METRIC SIZE	METRIC CAPACITY	METRIC SHIP WT/CTN	PACK
FG461100	BLA	Spring Platform Truck	44.13" l x 31" w x 32.5" h	11.3	14 cu ft	500 lb	60.0 lb	112.1 cm x 78.7 cm x 82.6 cm	.4 m ³	226.8 kg	27.2 kg	1
FG461400	BLA	Cube Truck	44.13" l x 31" w x 32.5" h	11.3	14 cu ft	500 lb	47.0 lb	112.1 cm x 78.7 cm x 82.6 cm	.4 m ³	226.8 kg	21.3 kg	1
FG461500 ^a	BLA	Lid for 14 ft. ³ Cube Trucks	44.13" l x 31" w x 8.5" h	N/A	N/A	N/A	17.2 lb	112.1 cm x 78.7 cm x 21.6 cm	N/A	N/A	7.8 kg	1

16-Cubic-Foot (12.9 Bushel)

NO.	COLOR	DESCRIPTION	U.S. DIMENSIONS	U.S. BUSHEL (BU)	U.S. SIZE	U.S. CAPACITY	U.S. SHIP WT/CTN	METRIC DIMENSIONS	METRIC SIZE	METRIC CAPACITY	METRIC SHIP WT/CTN	PACK
FG461600	BLA	Cube Truck	43.75" l x 31" w x 37" h	12.9	16 cu ft	500 lb	51.0 lb	111.1 cm x 78.7 cm x 94 cm	.5 m ³	226.8 kg	23.1 kg	1
FG461673	BLUE	Recycling Cube Truck	43.75" l x 31" w x 37" h	12.9	16 cu ft	500 lb	51.0 lb	111.1 cm x 78.7 cm x 94 cm	.5 m ³	226.8 kg	23.1 kg	1
1867537	BLACK	Executive Cube Truck w/ Quiet Casters	43.75" l x 31" w x 37" h	12.9	16 cu ft	500 lb	51.0 lb	111.1 cm x 78.7 cm x 94 cm	.5 m ³	226.8 kg	23.1 kg	1
FG471600	BLA	Utility Truck, Heavy-Duty with 5" dia (12.7 cm) Casters	44.38" l x 31" w x 38.25" h	12.9	16 cu ft	1,000 lb	74.3 lb	112.7 cm x 78.7 cm x 97.2 cm	.5 m ³	453.6 kg	33.7 kg	1
FG461500 ^a	BLA	Lid for 16 ft. ³ Cube Trucks	44.13" l x 31" w x 8.5" h	N/A	N/A	N/A	17.2 lb	112.1 cm x 78.7 cm x 21.6 cm	N/A	N/A	7.8 kg	1

20-Cubic-Foot (16.1 Bushel)

NO.	COLOR	DESCRIPTION	U.S. DIMENSIONS	U.S. BUSHEL (BU)	U.S. SIZE	U.S. CAPACITY	U.S. SHIP WT/CTN	METRIC DIMENSIONS	METRIC SIZE	METRIC CAPACITY	METRIC SHIP WT/CTN	PACK
FG461900	BLA	Cube Truck	48" l x 34.1" w x 36.5" h	16.1	20 cu ft	600 lb	60.0 lb	121.9 cm x 86.7 cm x 92.7 cm	.6 m ³	272.2 kg	27.2 kg	1
FG461800	BLA	Spring Platform Truck	48" l x 34.1" w x 36.5" h	16.1	20 cu ft	600 lb	75.0 lb	121.9 cm x 86.7 cm x 92.7 cm	.6 m ³	272.2 kg	34.0 kg	1
FG472000	BLA	Utility Truck, Heavy-Duty with 5" dia (12.7 cm) Casters	48.25" l x 34.1" w x 37.9" h	16.1	20 cu ft	1,200 lb	84.8 lb	122.6 cm x 86.7 cm x 96.2 cm	.6 m ³	544.3 kg	38.5 kg	1
FG461700 ^a	BLA	Lid for 20 ft. ³ Cube Trucks	48.5" l x 34" w x 8.5" h	N/A	N/A	N/A	18.8 lb	123.2 cm x 86.4 cm x 21.6 cm	N/A	N/A	8.5 kg	1

27-Cubic-Foot (21.7 Bushel)

NO.	COLOR	DESCRIPTION	U.S. DIMENSIONS	U.S. BUSHEL (BU)	U.S. SIZE	U.S. CAPACITY	U.S. SHIP WT/CTN	METRIC DIMENSIONS	METRIC SIZE	METRIC CAPACITY	METRIC SHIP WT/CTN	PACK
FG472700	BLA	Utility Truck, Heavy-Duty with 5" dia (12.7 cm) Corner Casters	59" l x 34" w x 42.9" h	21.7	27 cu ft	1,200 lb	105.0 lb	149.9 cm x 86.4 cm x 108.9 cm	.8 m ³	544.3 kg	47.6 kg	1
FG472741*	BLA	Towable Utility Truck, Heavy-Duty	59" l x 34" w x 42.9" h	21.7	27 cu ft	1,200 lb	120.0 lb	149.9 cm x 86.4 cm x 108.9 cm	.8 m ³	544.3 kg	54.4 kg	1
FG472600	BLA	Lid for 27 ft. ³ Cube Trucks	59.88" l x 34.5" w x 5" h	N/A	N/A	N/A	19.9 lb	152.1 cm x 87.6 cm x 12.7 cm	N/A	N/A	9.0 kg	1

Replacement Spring Kit

NO.	COLOR	DESCRIPTION	U.S. DIMENSIONS	U.S. BUSHEL (BU)	U.S. SIZE	U.S. CAPACITY	U.S. SHIP WT/CTN	METRIC DIMENSIONS	METRIC SIZE	METRIC CAPACITY	METRIC SHIP WT/CTN	PACK
FG461000	0000	Spring Kit for FG461100, FG461400 Trucks	34.2" l x 21.2" w x 0.5" h	N/A	N/A	N/A	12.0 lb	N/A	N/A	N/A	5.4 kg	1

*Requires 2-week lead time and is not returnable.
*Custom colors available; contact Customer Service for details.

UTILITY REFUSE AND RECYCLING

DECORATIVE REFUSE

CLEANING

MATERIAL HANDLING

WASHROOM

FOODSERVICE

ACCESSORIES & INDEX

Collapsible X-Carts

Durable, easy-to-maneuver cart efficiently transports large, bulky loads, then conveniently collapses to minimize storage footprint.

- Compact, collapsible frame enables efficient storage
- Durable vinyl bag accommodates bulky loads
- Easy-to-clean, detachable bag
- Color-coded ribbons classify transport materials to prevent cross-contamination
- Aesthetically pleasing black finish disguises stains and dirt
- High-quality TPR casters provide quiet operation
- Bumper guards help prevent damage to cart and facility during transport

1881781

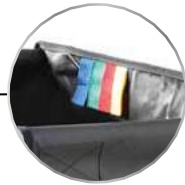

COLOR-CODED TABS

Organize your linen and/or waste collection. Select the color you wish to assign for the job and simply trim off the other three tabs.



PREMIUM QUIET CASTERS

Castors swivel for superior maneuverability, while bumper guards add extra protection during transport.

Compact, collapsible frame reduces width by 75% to enable efficient storage.



DURABLE CONSTRUCTION

Robust stainless steel with powder-coated finish will not warp or rust.

1881750



Six storage pockets hold cleaning tools, gloves, clothes, spray bottles, cleaning chemicals & more!



NO.	COLOR	DESCRIPTION	U.S. DIMENSIONS	U.S. BUSHELS	U.S. SIZE	U.S. CAPACITY	U.S. SHIP WT/CTN	METRIC DIMENSIONS	METRIC SIZE	METRIC CAPACITY	METRIC SHIP WT/CTN	PACK
1881749	BLACK	Collapsible X-Cart, 4 Bushels	24.1" l x 20.3" w x 34" h	4	5	220 lb	20.6 lb	61.2 cm x 51.6 cm x 86.4 cm	0.14 m ³	99.8 kg	9.3 kg	1
1881750	BLACK	Collapsible X-Cart, 8 Bushels	35.7" l x 24.1" w x 34" h	8	10	220 lb	27.0 lb	95.3 cm x 61.2 cm x 86.4 cm	0.28 m ³	99.8 kg	12.2 kg	1
1881781	BLACK	Collapsible Multi-Stream X-Cart (2 x 4 Bushels)	35.7" l x 24.1" w x 34" h	8	10	220 lb	28.6 lb	95.3 cm x 61.2 cm x 86.4 cm	0.28 m ³	99.8 kg	13.0 kg	1
1881782	BLACK	Collapsible X-Cart Replacement Bag, 4 Bushels	15.3" l x 22.4" w x 27.3" h	4	5	220 lb	4.46 lb	38.9 cm x 56.9 cm x 69.3 cm	0.14 m ³	99.8 kg	2.0 kg	2
1881783	BLACK	Collapsible X-Cart Replacement Bag, 8 Bushels	30.5" l x 22.4" w x 27.3" h	8	10	220 lb	6.1 lb	77.5 cm x 56.9 cm x 69.3 cm	0.28 m ³	99.8 kg	2.8 kg	2
1889863	BLACK	Collapsible X-Cart Cover, Small (for 1881749)	25.38" l x 19.88" w x 9.0" h				0.85 kg	25.38 cm l x 19.88 cm w x 9.0 cm h	0.85 kg			1
1889864	BLACK	Collapsible X-Cart Cover, Large (for 1881750 and 1881781)	35.0" l x 26.25" w x 9.0" h			1.17 kg	2.59 lbs.	35.0 cm l x 26.25 cm w x 9.0 cm h	1.17 kg			1

UTILITY REFUSE AND RECYCLING

DECORATIVE REFUSE

CLEANING

MATERIAL HANDLING

WASHROOM

FOODSERVICE

ACCESSORIES & INDEX



UTILITY REFUSE AND RECYCLING

DECORATIVE REFUSE

CLEANING

MATERIAL HANDLING

WASHROOM

FOODSERVICE

ACCESSORIES & INDEX



Integrated slotted v-notches for safe cutting



Ergonomic handle improves control and worker safety



Durable construction and large capacities to handle big loads



Versatile solutions for back- and front-of-house tasks

MOVE LOADS SAFELY AND EFFICIENTLY

The variable grip-height handle on our carts and trucks improves maneuverability and reduces muscle strain for most every user, regardless of height.



TRADITIONAL CART HANDLE DESIGN

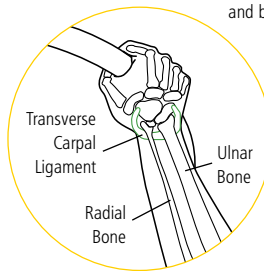

Angled handle helps keep wrist and bones in forearm aligned for optimum leverage while turning.

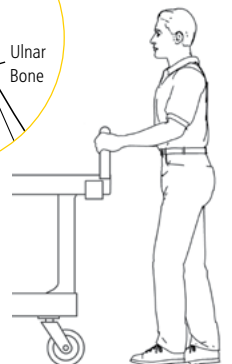

IMPROVED VARIABLE GRIP-HEIGHT HANDLE

Heavy-Duty Adaptable Carts

The Heavy-Duty Adaptable Cart provides superior versatility for tackling whatever task is at hand. It reduces the need for time-consuming user modifications with a variety of integrated features including: an ergonomic adjustable handle with four positions for maximum comfort, a flip-up shelf, locking casters, and numerous storage features designed to help organize tools and small parts.

- Four pack of snap-in hooks frees up cart shelf space and keeps extension cords and tools within reach, with numerous placement locations along the rim of RCP Heavy Duty Adaptable Carts. Compatible with RCP SKUs 1997206 and 1997208.
- Extended base attaches to RCP's Medium Heavy Duty Adaptable Carts to carry tall objects like 6' ladders or 4' light bulbs. Compatible with RCP SKUs 1997208 and 1997209.
- Two fixed and two swivel locking casters included. Compatible with RCP Heavy Duty Adaptable Carts (1997206, 1997207, 1997208, 1997209)



1997208



PACK OF 4 ACCESSORY HOOKS



OPTIONAL EXTENSION DRAWER

Can be added under the top shelf for additional storage of small parts and tools.



EXTENDED BASE

Can be added to the medium cart for carrying tall objects such as a ladder or box of 4' light bulbs.



NO.	COLOR	DESCRIPTION	U.S. DIMENSIONS	U.S. CAPACITY	U.S. SHIP WT/CTN	METRIC DIMENSIONS	METRIC CAPACITY	METRIC SHIP WT/CTN	CASTER TYPE	PACK
1997206	Black	Small Heavy-Duty Adaptable Cart	46.2" l x 17.75" w x 36.0" h	500 lb	37.20 lb	117.3 cm x 45.09 cm x 91.40 cm	226.8 kg	16.87 kg	5" TPR	1
1997208	Black	Medium Heavy-Duty Adaptable Cart	51.47" l x 25.20" w x 36.0" h	500 lb	49.0 lb	130.73 cm x 64.01 cm x 91.44 cm	226.8 kg	22.23 kg	5" TPR	1
1997227	Red	Pack of 4 Accessory Hooks	2.12" l x 3.54" w x 3.89" h	10 lb	0.70 lb	5.39 cm x 9 cm x 9.89 cm	4.54 kg	0.32 kg	N/A	4
1997230	Black	Medium Extended Base	25.35" l x 11.66" w x 6.50" h	40 lb	6.0 lb	64.39 cm x 29.62 cm x 16.51 cm	18.14 kg	2.72 kg	N/A	1
FG459300	Red	Extension Drawer	17.0" l x 25.0" w x 4.7" h	N/A	12.28 lb	43.18 cm x 63.50 cm x 11.94 cm	N/A	5.57 kg	N/A	1
1997371	Black	5" Replacement Caster Set (Locking)	5.69" l x 2.56" w x 5.82" h	N/A	4.60 lb	14.45 cm x 6.50 cm x 14.78 cm	N/A	2.09 kg	5" TPR	4
FG4592000000	Black	8" Replacement Caster Set	18.82" l x 12.57" w x 10.39" h	N/A	25.55 lb	47.8 cm x 31.93 cm x 26.39 cm	N/A	11.59 kg	8" Pneumatic	1

UTILITY REFUSE AND RECYCLING

DECORATIVE REFUSE

CLEANING

MATERIAL HANDLING

WASHROOM

FOODSERVICE

ACCESSORIES & INDEX

Heavy-Duty Utility Carts

Transport materials, supplies, and heavy loads securely in almost any environment.

- Available in lipped-shelf or flat-shelf models
- Ergonomic version comes with premium handle that optimizes hand placement

Lipped-Shelf models feature:

- Integrated V-notch to hold pipe and conduit securely for safe cutting
- Deep pocket shelves to keep loads secure

Flat-shelf models feature:

- Large, flat top shelf for oversized loads and smarter work surface
- Lower pocket shelf to keep loads secure



FG452089



FG452088



1997208



STAY ORGANIZED
Easy-reach tool/accessory hooks provide additional storage.



WORK MORE EFFICIENTLY
Built-in tool holster and caddy keep items at hand and in place during transport.



CUSTOMIZABLE
Molded-in fittings allow you to add pipe or rods to hold wire spools and other roll-type goods.

CART SIZES:

- 17 1/2" X 38 1/2"
- 25 1/4" X 44"
- 25 1/4" X 54"

CAPACITY RANGE (lbs)
500-750

UTILITY REFUSE AND RECYCLING

DECORATIVE REFUSE

CLEANING

MATERIAL HANDLING

WASHROOM

FOODSERVICE

ACCESSORIES & INDEX



FG452089

KEEP LOADS SECURE
Deep pocket shelves keep contents in place.



FG452089

STRUCTURAL FOAM CONSTRUCTION
Durable structural foam construction won't leak, rust, chip, dent, or peel.

Lipped-Shelf Carts

NO.	COLOR	DESCRIPTION	U.S. DIMENSIONS	U.S. CAPACITY	U.S. SHIP WT/CTN	METRIC DIMENSIONS	METRIC CAPACITY	METRIC SHIP WT/CTN	CASTER TYPE	PACK
FG450088	BLA, BEIG	Ergo Handle Utility Cart (Small)	39" l x 17.88" w x 33.25" h	500 lb	30.8 lb	99.1 cm x 45.4 cm x 84.5 cm	226.8 kg	14.0 kg	5" TPR	1
FG452088	BLA, BEIG	Ergo Handle Utility Cart (Med)	44" l x 25.25" w x 39" h	500 lb	42.8 lb	111.8 cm x 64.1 cm x 99.1 cm	226.8 kg	19.4 kg	5" TPR	1
FG452010	BLA	Ergo Handle Utility Cart (Med) with Pneumatic Casters	45.25" l x 25.88" w x 37.12" h	500 lb	63.0 lb	114.9 cm x 65.7 cm x 94.3 cm	226.8 kg	28.6 kg	8" Pneumatic	1
FG454600	BLA	Ergo Handle Utility Cart (Large)	55" l x 26" w x 33.25" h	750 lb	52.4 lb	139.7 cm x 66 cm x 84.5 cm	340.2 kg	23.8 kg	5" TPR	1
FG454610	BLA	Ergo Handle Utility Cart (Large) with Pneumatic Casters	55" l x 26" w x 33.25" h	750 lb	71.0 lb	139.7 cm x 66 cm x 84.5 cm	340.2 kg	32.2 kg	8" Pneumatic	1
FG450089	BLA, BEIG	Flat Handle Utility Cart (Small)	39" l x 17.88" w x 33.25" h	500 lb	31.1 lb	99.1 cm x 45.4 cm x 84.5 cm	226.8 kg	14.1 kg	5" TPR	1
FG452089	BLA, BEIG	Flat Handle Utility Cart (Med)	45.25" l x 25.88" w x 33.25" h	500 lb	44.7 lb	114.9 cm x 65.7 cm x 84.5 cm	226.8 kg	20.3 kg	5" TPR	1
FG9T6600*	BLA	Flat Handle Utility Cart (Small) with 5" Casters	34.25" l x 17.375" w x 31.5" h	500 lb	30.8 lb	87.0 cm x 44.1 cm x 80.0 cm	226.8 kg	14.0 kg	5" (12.7 cm)	12
FG9T6700*	BLA	Flat Handle Utility Cart (Med) with 5" Casters	40.25" l x 25.63" w x 32.5" h	500 lb	42.8 lb	102.2 cm x 65.1 cm x 82.6 cm	226.8 kg	19.4 kg	5" (12.7 cm)	10

Flat-Shelf Carts

NO.	COLOR	DESCRIPTION	U.S. DIMENSIONS	U.S. CAPACITY	U.S. SHIP WT/CTN	METRIC DIMENSIONS	METRIC CAPACITY	METRIC SHIP WT/CTN	CASTER TYPE	PACK
FG450500	BLA, BEIG	Ergo Handle Utility Cart (Small)	37.88" l x 19.2" w x 33.3" h	500 lb	29.5 lb	96.2 cm x 48.8 cm x 84.6 cm	226.8 kg	13.4 kg	5" TPR	1
FG452500	BLA, BEIG	Ergo Handle Utility Cart (Med)	43.88" l x 25.88" w x 33.3" h	500 lb	41.0 lb	111.5 cm x 65.7 cm x 84.6 cm	226.8 kg	18.6 kg	5" TPR	1
FG454500	BLA	Ergo Handle Utility Cart (Large)	54" l x 25.25" w x 36" h	750 lb	52.4 lb	137.2 cm x 64.1 cm x 91.4 cm	340.2 kg	23.8 kg	5" TPR	1
FG450589	BLA, BEIG	Flat Handle Utility Cart (Small)	37.88" l x 19.2" w x 33.3" h	500 lb	29.5 lb	96.2 cm x 48.8 cm x 84.6 cm	226.8 kg	13.4 kg	5" TPR	1
FG452589	BLA, BEIG	Flat Handle Utility Cart (Med)	43.88" l x 25.88" w x 33.3" h	500 lb	41.0 lb	111.5 cm x 65.7 cm x 84.6 cm	226.8 kg	18.6 kg	5" TPR	1

*Pallet Pack

ACCESSORIZE AND CUSTOMIZE FOR YOUR NEEDS



FG459000 3-OUTLET POWER STRIP



FG335388 8-GALLON REFUSE BIN



FG459300 SINGLE FULL EXTENSION DRAWER (see Cart Accessories)



UTILITY REFUSE AND RECYCLING

DECORATIVE REFUSE

CLEANING

MATERIAL HANDLING

WASHROOM

FOODSERVICE

ACCESSORIES & INDEX

Trades Carts

Moves productivity right to the worksite—a complete tool storage and mobile workbench system.

- Four compartmentalized boxes for storing assorted parts and hardware
- Fully enclosed, lockable storage compartment helps keep tools and materials secure (FG618088)
- Two storage bins hold essential hand tools and supplies
- Carts move easily over hard surfaces and through elevators and doorways
- Flat surface at user-friendly height provides convenient work area
- Nonmarking, 5" casters for easy mobility
- Optional Refuse Bin (FG335388) and Utility Bin (FG335488)



FG618088BLA

Convenient lockable cabinet



FG618088BLA

Four compartment drawers for assorted parts



FG618000BLA



FG618088BLA

NO.	COLOR	DESCRIPTION	U.S. DIMENSIONS	U.S. CAPACITY	U.S. SHIP WT/CTN	METRIC DIMENSIONS	METRIC CAPACITY	METRIC SHIP WT/CTN	PACK
FG618000	BLA	Trades Cart with 5" (12.7 cm) Casters includes 2 parts boxes and 4 parts bins	38" l x 19.25" w x 33.38" h	180 lb top shelf, 150 lb bottom shelf	50.3 lb	96.5 cm x 48.9 cm x 84.8 cm	81.6 kg top shelf, 68 kg bottom shelf	22.8 kg	1
FG618088	BLA	Trades Cart with Locking Cabinet includes 2 parts boxes and 4 parts bins	38" l x 19.25" w x 33.38" h	180 lb top shelf, 150 lb bottom shelf	68.0 lb	96.5 cm x 48.9 cm x 84.8 cm	81.6 kg top shelf, 68 kg bottom shelf	30.8 kg	1

5-Drawer Mobile Work Center

Heavy-duty work surface supports up to 250 lbs.

- Built-in cord wrap provides neat, convenient storage of power tools and work lights
- Casters allow easy maneuverability and are lockable for safety
- Locking bar provides security and keeps drawers from sliding open during transport
- Pegboard side panels provide convenient tool organization



FG773488BLA



FG773488BLA

NO.	COLOR	DESCRIPTION	U.S. DIMENSIONS	U.S. CAPACITY	U.S. SHIP WT/CTN	METRIC DIMENSIONS	METRIC CAPACITY	METRIC SHIP WT/CTN	PACK
FG773488	BLA	5-Drawer Mobile Work Center	32.63" l x 19.9" w x 33.5" h	250 lb	69.0 lb	82.9 cm x 50.5 cm x 85.1 cm	113.4 kg	31.3 kg	1

UTILITY REFUSE AND RECYCLING

DECORATIVE REFUSE

CLEANING

MATERIAL HANDLING

WASHROOM

FOODSERVICE

ACCESSORIES & INDEX

TradeMaster® Mobile Cabinets and Work Centers

Easily transport tools and supplies where you need them.

- Features locking cabinet doors and 4" deep drawers for versatile tool and supply storage and organization
- Drawers feature commercial-quality, ball-bearing slides
- Metal-reinforced structural foam shelves engineered for durability
- Arrives 90% assembled



FG451288BLA



FG451388BLA



FG453388BLA

NO.	COLOR	DESCRIPTION	U.S. DIMENSIONS	U.S. CAPACITY	U.S. SHIP WT/CTN	METRIC DIMENSIONS	METRIC CAPACITY	METRIC SHIP WT/CTN	PACK
FG451288	BLA	TradeMaster® Cart with 2-Door Cabinet, Small	41.63" l x 18.25" w x 38.38" h	500 lb	57.1 lb	105.7 cm x 46.4 cm x 97.5 cm	226.8 kg	25.9 kg	1
FG451388	BLA	TradeMaster® Cart with 4 Drawers	40.63" l x 18.38" w x 33.38" h	500 lb	86.9 lb	103.2 cm x 46.7 cm x 84.8 cm	226.8 kg	39.4 kg	1
FG453388	BLA	TradeMaster® Cart with 4 Drawers and Cabinet, Small	49" l x 26.25" w x 38" h	750 lb	123.0 lb	124.5 cm x 66.7 cm x 96.5 cm	340.2 kg	55.8 kg	1

Convertible Utility Cart

Converts from a utility cart to a platform truck in just seconds.

- Innovative design
- Multifunctional productivity with improved worker well-being—saving you time and money



PUSH BUTTONS

Depress buttons to easily convert from utility cart to platform truck.



LOCKING CASTERS

Rear wheel locks keep cart safely in place while loading and unloading.



FOOT PEDAL

Depress foot pedal to fold cart for storage.



FOLDS FROM 34 3/8" TO 10 7/8" FOR EASY STORAGE

QUICK CONVERSION

Easily converts from a utility cart to a platform truck and then folds flat for storage.



UTILITY CART



PLATFORM TRUCK



Convertible Utility Cart

NO.	COLOR	DESCRIPTION	U.S. DIMENSIONS	U.S. CAPACITY	U.S. SHIP WT/CTN	METRIC DIMENSIONS	METRIC CAPACITY	METRIC SHIP WT/CTN	PACK
FG430000	BLA	Convertible Utility Cart	45.2" l x 23.8" w x 34.4" h (Utility)	400 lb	52.0 lb	115 cm x 60.5 cm x 87.4 cm (Utility)	181 kg	23.6 kg	1

UTILITY REFUSE AND RECYCLING

DECORATIVE REFUSE

CLEANING

MATERIAL HANDLING

WASHROOM

FOODSERVICE

ACCESSORIES & INDEX

Executive Series™ Service Cart

The Executive Series™ Service Cart. is an elegant and versatile solution for back- and front-of-house tasks. With 20% more top-shelf capacity, it's constructed of durable, recyclable polyethylene and it's easy to clean—keeping your business looking smart for years.



EXECUTIVE SERIES™

FG9T6800BLA

ERGONOMIC ROUNDED HANDLES

Improves maneuverability and comfort.

WRAPAROUND END PANELS

Conceals cart contents.

SOLID ROUNDED BUMPER

Gentle on walls and furniture.

300-LB LOAD CAPACITY

Holds 100 lbs per shelf.



FG9T6800BLA

ATTRACTIVE STYLING

Ideal for front-of-house use.



FG9T6800BLA

INCREASED CAPACITY

Accommodates two standard bus boxes on top shelf.

NO.	COLOR	DESCRIPTION	U.S. DIMENSIONS	U.S. CAPACITY	U.S. SHIP WT/CTN	METRIC DIMENSIONS	METRIC CAPACITY	METRIC SHIP WT/CTN	PACK
⑤ FG9T6800	BLA	Executive Service Cart	39" l x 21" w x 38" h	300 lbs	31.5 lb	99.1 cm x 53.3 cm x 96.5 cm	136 kg	14.3 kg	1

Accessories

NO.	COLOR	DESCRIPTION	U.S. DIMENSIONS	U.S. CAPACITY	U.S. SHIP WT/CTN	METRIC DIMENSIONS	METRIC CAPACITY	METRIC SHIP WT/CTN	PACK
FG335388	BLA	Refuse Bin	12" l x 17" w x 22" h	8 gal	9.0 lb	30.5 cm x 43.2 cm x 55.9 cm	30.3 L	4.1 kg	2
FG335488	BLA	Utility Bin	12.13" l x 17" w x 10.5" h	4 gal	5.4 lb	30.8 cm x 43.2 cm x 26.7 cm	15.1 L	2.4 kg	2
FG334900 ^a	WHT, GRAY	Bus/Utility Box	20" l x 15" w x 5" h	4.625 gal	20.6 lb	50.8 cm x 38.1 cm x 12.7 cm	17.5 L	9.3 kg	12

^aCertified to NSF Standard #2 for food contact.

When ordering products with **BOLD** color codes, please specify color code after the product number. Refer to the Standard Color Guide at the back of the catalog.

UTILITY REFUSE AND RECYCLING

DECORATIVE REFUSE

CLEANING

MATERIAL HANDLING

WASHROOM

FOODSERVICE

ACCESSORIES & INDEX

Service Carts

Versatile, durable carts perform a wide variety of tasks.

- Molded shelves won't rust, dent, or require painting
- Easy-to clean, smooth surfaces
- Convenient handles and compact size enhance maneuverability
- Assists in complying with HACCP guidelines
- Nonmarking swivel casters reduce touch-up cleaning



FG9T6571



FG342100



FG345700



FG335588

NO.	COLOR	DESCRIPTION	U.S. DIMENSIONS	U.S. CAPACITY	U.S. SHIP WT/CTN	METRIC DIMENSIONS	METRIC CAPACITY	METRIC SHIP WT/CTN	PACK
FG9T6571 ^a	BEIG	Utility Cart with 3" dia (7.6 cm) Swivel Casters	31.5" l x 16.25" w x 36" h	100 lb	212.0 lb	80 cm x 41.3 cm x 91.4 cm	45.3 kg	96.2 kg	6
FG342100	BLA	Utility Cart with 3" dia (7.6 cm) Swivel Casters and End Panels	33.63" l x 18.63" w x 36.63" h	150 lb	34.0 lb	85.4 cm x 47.3 cm x 93 cm	68.0 kg	15.4 kg	1
FG342488	RED, PLAT, OWHT, BLA	Utility Cart with 4" dia (10.2 cm) Swivel Casters	33.63" l x 18.63" w x 37.75" h	200 lb	30.0 lb	85.4 cm x 47.3 cm x 95.9 cm	90.7 kg	13.6 kg	1
FG345700	BLA	Utility Cart with Lockable Doors, Sliding Drawer, and 4" dia (10.2 cm) Swivel Casters	33.63" l x 18.63" w x 37.75" h	200 lb	44.8 lb	85.4 cm x 47.3 cm x 95.9 cm	90.7 kg	20.3 kg	1
FG335588	PLAT	Utility Cart with Enclosed End Panels	31" l x 18" w x 37.5" h	300 lb	37.5 lb	78.7 cm x 45.7 cm x 95.3 cm	136.1 kg	17.0 kg	1

^a Pallet Pack

Xtra™ Carts

Durable and attractive carts storage and transportation for front- and back-of-house applications.

- Metal uprights and molded shelves engineered for durability and appearance
- Nonmarking 4" swivel casters
- Wide shelves hold a variety of equipment and supplies, up to 300 lbs
- Available with locking doors and enclosure panels
- Accessories include refuse and utility bins (see page 183)



FG409300



FG409400



FG409500



FG409600

NO.	COLOR	DESCRIPTION	U.S. DIMENSIONS	U.S. CAPACITY	U.S. SHIP WT/CTN	METRIC DIMENSIONS	METRIC CAPACITY	METRIC SHIP WT/CTN	PACK
FG409100	OWHT, GRAY, BLA	Utility Cart, Open-Sided	40.63" l x 20" w x 37.8" h	300 lb	43.4 lb	103.2 cm x 50.8 cm x 96 cm	136.1 kg	19.7 kg	1
FG409300	OWHT, BLA	Utility Cart with Enclosed End Panels on 3 Sides	40.63" l x 20" w x 37.8" h	300 lb	51.6 lb	103.2 cm x 50.8 cm x 96 cm	136.1 kg	23.4 kg	1
FG409400	GRAY	Instrument Cart with Lockable Doors and Sliding Drawers	40.63" l x 20" w x 37.8" h	300 lb	52.0 lb	103.2 cm x 50.8 cm x 96 cm	136.1 kg	23.6 kg	1
FG409500	BLA	Equipment Cart	40.63" l x 20.75" w x 37.8" h	300 lb	58.5 lb	103.2 cm x 52.7 cm x 96 cm	136.1 kg	26.5 kg	1
FG409600	BLA	4-Shelf Cart, Open-Sided	40.63" l x 20" w x 51" h	300 lb	52.0 lb	103.2 cm x 50.8 cm x 129.5 cm	136.1 kg	23.6 kg	1



UTILITY REFUSE AND RECYCLING

DECORATIVE REFUSE

CLEANING

MATERIAL HANDLING

WASHROOM

FOODSERVICE

ACCESSORIES & INDEX



Ideal for moving loads in a variety of environments



Versatile solutions for any environment.



Efficiently transport large, bulky loads



Innovative designs to improve productivity

DURAMOLD™ REAL WORLD RUGGED — TESTED TOUGH

Rubbermaid's exclusive Duramold™ technology exceeds the highest performance standards in the industry. We test and retest our products to meet rigorous durability standards, and our material handling products are no exception. Real-world rugged durability, innovative technology, and best-in-class features combine to create longer-lasting products that carry heavy loads—and make your work easier.

WILL NOT WARP, DENT, SPLINTER, RUST, OR ROT

Tough, resilient surface absorbs impact and provides quiet operation. Virtually maintenance-free; resistant to most chemicals, impervious to water damage, and easily cleaned.



Metal—dents and rusts



Wood—splinters and rots



40 buckets of sheetrock compound weigh over 2,400 lbs

DURAMOLD™ precision-engineered resin and steel composite decks
HOLD & TRANSPORT UP TO

2500 lbs.

of weight load capacity

Duramold™ decks are formed from a precision-engineered resin and metal composite structure that is lighter than typical steel/wood products without sacrificing strength, which enables weight reduction and improved ergonomics.



PUT YOUR EFFORT INTO MOVING YOUR PAYLOAD, NOT YOUR TRUCK

DURAMOLD™ HAS THE HIGHEST STRENGTH-TO-WEIGHT RATIO

when compared to metal, wood, and solid plastic decks.

Heavy-Duty Platform Trucks

Ideal for moving large, heavy, oversized loads in a variety of environments from retail to construction.

DURAMOLD

DECK SIZES:

- 24" X 36"
- 24" X 48"
- 30" X 60"

CAPACITY RANGE (lbs)
1000-2500

IMPROVED MANEUVERABILITY
Variable grip-height handle improves control and worker safety.

VIRTUALLY MAINTENANCE-FREE
Powder-coated steel creates a hard finish that is far tougher than conventional paint.



BUILT-IN SAFETY FEATURES
Retainer clips prevent unintended handle removal.

SECURE SMALL ITEMS
Perimeter deck channel retains small items.

KEEP LOADS IN PLACE
Textured deck surface reduces load slippage.

RUGGED CONSTRUCTION
Duramold's™ exclusive, precision-engineered resin and metal composite structure provides maximum load support.



BETTER LOAD RETENTION
Four molded-in tie-down slots for securing loads with tie-down straps or bungees.



FG440300



FG440000BLA

Three-position handle provides better mobility and convenient storage.



NO.	COLOR	DESCRIPTION	U.S. DIMENSIONS	U.S. CAPACITY	U.S. SHIP WT/CTN	METRIC DIMENSIONS	METRIC CAPACITY	METRIC SHIP WT/CTN	CASTER TYPE	PACK
FG440300	BLA	Heavy-Duty Platform Truck	36" l x 24" w	1,000 lb	50.0 lb	91.4 cm x 61 cm	453.6 kg	22.7 kg	6" TPR	1
FG440600	BLA	Heavy-Duty Platform Truck	36" l x 24" w	2,000 lb	50.0 lb	91.4 cm x 61 cm	453.6 kg	22.7 kg	6" Polyolefin	1
FG443600	BLA	Heavy-Duty Platform Truck (Med 24" x 48")	48" l x 24" w	2,000 lb	70.0 lb	121.9 cm x 61 cm	453.6 kg	31.8 kg	8" TPR	1
FG443610	BLA	Heavy-Duty Platform Truck	48" l x 24" w	1,200 lb	75.0 lb	121.9 cm x 61 cm	544.3 kg	34 kg	8" Pneumatic	1
FG444100	BLA	Heavy-Duty Platform Truck	48" l x 24" w	2,500 lb	69.0 lb	121.9 cm x 61 cm	1,134.0 kg	31.3 kg	8" Polyolefin	1
FG446600	BLA	Heavy-Duty Platform Truck	60" l x 30" w	2,000 lb	87.9 lb	152.4 cm x 76.2 cm	907.2 kg	39.9 kg	8" TPR	1
FG446610	BLA	Heavy-Duty Platform Truck	60" l x 30" w	1,200 lb	90.0 lb	152.4 cm x 76.2 cm	544.3 kg	40.8 kg	8" Pneumatic	1
FG447100	BLA	Heavy-Duty Platform Truck	60" l x 30" w	2,500 lb	84.0 lb	152.4 cm x 76.2 cm	1,134.0 kg	38.1 kg	8" Polyolefin	1
FG440000	BLA	Triple™ Trolley, Utility-Duty with Straight Handle and 3" (7.6 cm) Casters	32.5" l x 20.5" w	250 lb	20.6 lb	82.6 cm x 52.1 cm	113.4 kg	9.3 kg	1	1
FG440100	BLA	Triple™ Trolley, Standard Duty with User-Friendly Handle and 5" dia x .875" w (12.7 cm x 2.22 cm) Casters	32.5" l x 20.5" w	500 lb	25.4 lb	82.6 cm x 52.1 cm	226.8 kg	11.5 kg	1	1



Sheet and Panel Trucks and A-Frame Panel Trucks

Transport large, bulky sheet goods and hard-to-handle loads such as doors, lumber, drywall, tables, and cubicle walls.



MOVE HARD-TO-HANDLE LOADS

Three removable powder-coated steel vertical frames provide support for bulky loads. Frames can be removed as needed based on load requirements.

BUILT-IN SAFETY FEATURES

Retainer clips lock frames securely in place and prevent unintended removal. Four tie-down points, two on each side, help with load retention.

FG446800

RUGGED CONSTRUCTION

Duramold's™ exclusive, precision-engineered resin and metal composite structure provides maximum load support.



HOLDS SHEET GOODS SECURELY

High-side inclined frame and side rail hold load firmly in place during transit.



KEEP LOADS IN PLACE

Textured deck surface reduces load slippage.

FG446300



Sheet and Panel Truck

NO.	COLOR	DESCRIPTION	U.S. DIMENSIONS	U.S. CAPACITY	U.S. SHIP WT/CTN	METRIC DIMENSIONS	METRIC CAPACITY	METRIC SHIP WT/CTN	CASTER TYPE	PACK
FG446800	BLA	Sheet and Panel Truck (24" x 48")	47.9" l x 24.25" w x 39.9" h	2,000 lb	98.0 lb	121.7 cm x 61.6 cm x 101.3 cm	907.2 kg	44.5 kg	8" Polyolefin	1

A-Frame Panel Truck

NO.	COLOR	DESCRIPTION	U.S. DIMENSIONS	U.S. CAPACITY	U.S. SHIP WT/CTN	METRIC DIMENSIONS	METRIC CAPACITY	METRIC SHIP WT/CTN	CASTER TYPE	PACK
FG446300	BLA	A-Frame Panel Truck (24" x 48")	47.9" l x 24.25" w x 44.9" h	2,000 lb	87.0 lb	121.7 cm x 61.6 cm x 114 cm	907.2 kg	39.5 kg	8" Polyolefin	1

UTILITY REFUSE AND RECYCLING

DECORATIVE REFUSE

CLEANING

MATERIAL HANDLING

WASHROOM

FOODSERVICE

ACCESSORIES & INDEX

Side-Panel Platform Truck

Ideal for transporting small packages and materials.



CUSTOMIZABLE

Remove one, two, three, or all four side panels to accommodate any size load.



ENHANCE USER COMFORT

Side panel cutouts allow easy access to load.



BUILT-IN SAFETY FEATURES

Retainer clips prevent unintended handle removal.

RUGGED CONSTRUCTION

Duramold's™ exclusive, precision-engineered resin and metal composite structure provides maximum load support.

FG448600

3" X 3" GRID SIDE PANELS

Heavy-duty wire side panels retain small packages and items.

BETTER LOAD RETENTION

Molded-in tie-down slots increase load security. Textured deck surface reduces load slippage.

NO.	COLOR	DESCRIPTION	U.S. DIMENSIONS	U.S. CAPACITY	U.S. SHIP WT/CTN	METRIC DIMENSIONS	METRIC CAPACITY	METRIC SHIP WT/CTN	CASTER TYPE	PACK
FG448600	BLA	Side-Panel Platform Truck (24" x 48")	56" l x 24.25" w x 41.25" h	2,000 lb	105.0 lb	142.2 cm x 61.6 cm x 104.8 cm	907.2 kg	47.6 kg	8" TPR	1

UTILITY REFUSE AND RECYCLING

DECORATIVE REFUSE

CLEANING

MATERIAL HANDLING

WASHROOM

FOODSERVICE

ACCESSORIES & INDEX

CASTERS TO MEET YOUR NEEDS

Rubbermaid's best-in-class heavy-duty casters have been specially chosen for each of our products to meet your most demanding environments.



POLYOLEFIN

Hard-tread polyolefin casters roll easier than soft tread casters. Nonmarking, impact- and chemical-resistant casters won't flat-spot under static loads or pick up metal shavings, nails, and other debris.



PNEUMATIC

Pneumatic casters provide a cushioned and quiet ride for fragile loads, making them ideal for rough and uneven surfaces, inside and out.



THERMOPLASTIC RUBBER

TPR casters absorb shock, provide floor surface protection, and quiet operation. Chemical- and water-resistant.

CASTER PERFORMANCE GUIDE

	CASTER TREAD MATERIAL	MOLD-ON RUBBER (TPR)	POLYOLEFIN	PNEUMATIC
FLOOR SURFACE	ASPHALT	Excellent	Fair	Excellent
	BRICK	Excellent	Fair	Excellent
	CARPET	Excellent	Good	Excellent
	CONCRETE	Excellent	Good	Excellent
	LINOLEUM / COMPOSITION TILE	Excellent	Fair	Excellent
	STEEL – RIBBED	Good	Fair	Excellent
	STEEL – SMOOTH	Good	Good	Excellent
	TERRAZZO	Excellent	Fair	Excellent
	WOOD	Excellent	Good	Excellent
OPERATING CONDITIONS	MILD CHEMICALS	Fair	Good	Good
	HARSH CHEMICALS	Fair	Fair	Good
	METAL SCRAPS – SMALL	Excellent	Good	Good
	METAL SCRAPS – LARGE	Excellent	Fair	Good
	ANIMAL FATS	Good	Good	Good
	OIL AND GREASE	Fair	Good	Fair
	WATER AND STEAM	Good	Excellent	Good
	OTHER FACTORS	FLOOR PROTECTION	Excellent	Good
QUIET OPERATION	Excellent	Fair	Excellent	
CUSHION LOAD	Excellent	N/A	Excellent	
IMPACT RESISTANCE	Excellent	Good	Excellent	
ROLLING EASE	Fair	Excellent	Fair	
ABRASION RESISTANCE (NONCHIPPING)	Fair	Good	Fair	
NON-FLAT-SPOTTING (UNDER STATIC LOAD)	Fair	Excellent	N/A	

UTILITY REFUSE
AND RECYCLING

DECORATIVE REFUSE

CLEANING

MATERIAL HANDLING

WASHROOM

FOODSERVICE

ACCESSORIES
& INDEX

Cart Accessories



FG335388



FG335488



FG459000



FG459100



FG459200



FG459300

Cart No.	FG335388 8-Gal (30.3 L) Refuse Bin Ship Weight: 9 lb/4.1 kg Pack: 2 Color: BLA	FG335488 4-Gal (15.3 L) Utility Bin Ship Weight: 5.4 lb/2.4 kg Pack: 2 Color: BLA	FG459000 3-Outlet, Surge-Protected Power Strip with 10' Cord Ship Weight: 3.4 lb/1.5 kg Pack: 1 Color: BLA	FG459100 Hook Kit (Set of 4) Ship Weight: 3.3 lb/1.5 kg Pack: 1 Color: BLA	FG459200 8" Pneumatic Caster Kit Ship Weight: 23.6 lb/11.6 kg Pack: 1 Color: 0000	FG459300 Single Full-Extension Drawer Ship Weight: 13.5 lb/6.1 kg Pack: 1 Color: RED	FG619900 Utility Sliding Drawer Ship Weight: 4.5 lb/2 kg Pack: 1 Color: BBN, BLA
FG335588 Service Cart with Swivel Casters	✓	✓					
FG342100 Service Cart with 3" Swivel Casters	✓	✓					
FG342488 Service Cart with 4" Swivel Casters	✓	✓					
FG345700 Service Cart with Lockable Doors and Sliding Drawer	✓	✓					✓
FG409100 Open-Sided Utility Cart	✓	✓					✓
FG409300 Utility Cart with Enclosed End Panels on 3 Sides	✓	✓					✓
FG409400 Service Cart with Lockable Doors and Sliding Drawer	✓	✓					✓
FG409500 Service Cart with Lockable Doors, Enclosed on 3 Sides	✓	✓					✓
FG409600 4-Shelf Service Cart	✓	✓	✓	✓	✓		
FG450088 Heavy-Duty Ergo Handle Utility Cart, Small	✓	✓	✓	✓	✓		
FG451288 TradeMaster® Cart with 2-Door Cabinet	✓	✓	✓	✓	✓		
FG451388 TradeMaster® Cart with 4-Drawers	✓	✓	✓	✓	✓		
FG452010 Heavy-Duty Ergo Handle Utility Cart with Pneumatic Casters	✓	✓	✓	✓	✓	✓	
FG452088 Heavy-Duty Ergo Handle Utility Cart, Medium	✓	✓	✓	✓	✓		
FG453388 TradeMaster® Cart with 4-Drawers and Cabinet, Small	✓	✓	✓	✓	✓		
FG454600 Heavy-Duty Ergo Handle Utility Cart	✓	✓	✓	✓	✓	✓	
FG454610 Heavy-Duty Ergo Handle Utility Cart with Pneumatic Casters	✓	✓	✓	✓	✓	✓	
FG9T6600 2-Shelf Flat Handle Utility Cart			✓	✓	✓		
FG9T6700 2-Shelf Flat Handle Utility Cart			✓	✓	✓		
FG9T6800 Executive Series™ Service Cart	✓	✓					

UTILITY REFUSE AND RECYCLING

DECORATIVE REFUSE

CLEANING

MATERIAL HANDLING

WASHROOM

FOODSERVICE

ACCESSORIES & INDEX



UTILITY REFUSE AND RECYCLING

DECORATIVE REFUSE

CLEANING

MATERIAL HANDLING

WASHROOM

FOODSERVICE

ACCESSORIES & INDEX

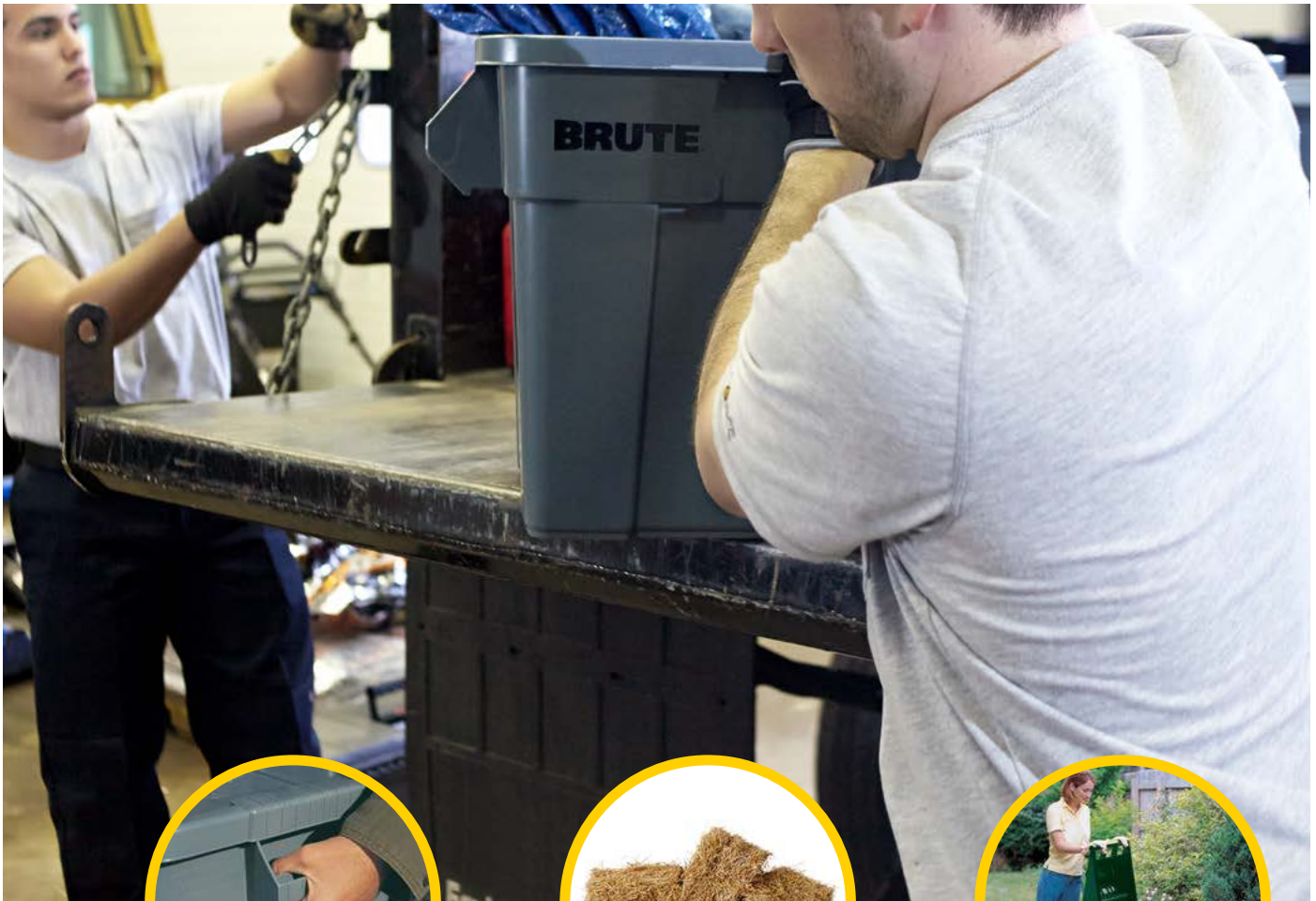

Ergonomic designs allow for easy transport



Super tough construction for superior performance



Designed for heavy-duty, long lasting use

Why Structural Foam?

STRENGTH

Superior strength without the need for a metal frame

DURABILITY

Seamless structures won't leak, rust, chip, dent, or peel, even under the heaviest use.

EFFICIENCY

Lighter weight means easier to operate. Structural foam construction minimizes maintenance.



When ordering products with **BOLD** color codes, please specify color code after the product number. Refer to the Standard Color Guide at the back of the catalog.

Stock Tanks

Super-tough structural foam construction for superior performance and durability in all kinds of weather.

- Four sizes to fit all your watering needs, from 50 to 300 gallons
- Seamless construction for outstanding durability
- Oversize 1½" drain plug for easy draining and cleaning
- All-plastic anti-siphon float valve provides constant water level

STEPPED SIDEWALLS
Resist bowing and provide added stability.

SEAMLESS DESIGN
Prevents leaking and cracking.

REINFORCED RIBBING
Provides added strength and durability.



FG424288



FG424700



FG424300

FLOAT VALVE OPTION

STOCK TANK DRAIN PLUG KIT



FG424806 fits all Rubbermaid® Stock Tanks.



FG505012 fits all Rubbermaid® Stock Tanks.

NO.	COLOR	DESCRIPTION	U.S. DIMENSIONS	U.S. CAPACITY	U.S. SHIP WT/CTN	METRIC DIMENSIONS	METRIC CAPACITY	METRIC SHIP WT/CTN	PACK
FG424300	BLA	50 U.S. Gallon Stock Tank	52" l x 31" w x 12" h	50 gal	23.5 lb	132.1 cm x 78.7 cm x 30.5 cm	189.2 L	10.7 kg	1
FG424288	BLA	100 U.S. Gallon Stock Tank	53" l x 31" w x 25" h	100 gal	32.4 lb	134.6 cm x 78.7 cm x 63.5 cm	378.5 L	14.7 kg	1
FG424500	BLA	150 U.S. Gallon Stock Tank	58" l x 39" w x 25" h	150 gal	53.0 lb	147.3 cm x 99.1 cm x 63.5 cm	567.8 L	24.0 kg	1
FG424700	BLA	300 U.S. Gallon Stock Tank	63.25" l x 69" w x 25" h	300 gal	83.0 lb	160.7 cm x 175.3 cm x 63.5 cm	1135.5 L	37.6 kg	1
FG424806	BLA	Stock Tank Float Valve	9" l x 5" w x 6.25" h	N/A	12.0 lb	22.9 cm x 12.7 cm x 15.9 cm	N/A	5.4 kg	6
FG505012		Stock Tank Drain Plug Kit	N/A	N/A	2.5 lb	N/A	N/A	1.1 kg	12



Big Wheel® Carts

Designed for heavy-duty, long-lasting use.

- Smooth, all-plastic, one-piece tub construction is easy to dump and clean
- Large pneumatic wheels provide maneuverability (FG564200)
- Large 20" semi-pneumatic wheels roll smoothly over rough surfaces (FG565461)
- FG565461 has a weighted load capacity of 200 lbs and holds up to 3.5 cu ft (.09 m³) level capacity or 4.0 cu ft (.11 m³) heaped capacity
- FG564200 has a weighted load capacity of 300 lbs and holds up to 7.5 cu ft (.2 m³) level capacity or 8.75 cu ft (.25 m³) heaped capacity



FG564200BLA

NO.	COLOR	DESCRIPTION	U.S. DIMENSIONS	U.S. LOAD	U.S. SIZE	U.S. SHIP WT/CTN	METRIC DIMENSIONS	METRIC LOAD	METRIC SIZE	METRIC SHIP WT/CTN	PACK
FG564200	BLA	7.5-Cu.-Ft. Big Wheel® Cart	58" l x 32.75" w x 28.25" h	300 lb	7.5 cu ft	45.2 lb	147.3 cm x 83.2 cm x 71.8 cm	136 kg	.21 m³	20.5 kg	1
FG565461	BLA	3.5-Cu.-Ft. Big Wheel® Cart (Unassembled)	47" l x 27.5" w x 24.75" h	200 lb	3.5 cu ft	38.2 lb	119.4 cm x 69.9 cm x 62.9 cm	90.7 kg	.09 m³	17.3 kg	1
M1564200		Wheel for FG564200	N/A	N/A	N/A	N/A	N/A	N/A	N/A	N/A	1
50565400		Axle for FG565461	N/A	N/A	N/A	N/A	N/A	N/A	N/A	N/A	1
52564200		Axle for FG564200	N/A	N/A	N/A	4.93 lb	N/A	N/A	N/A	N/A	1

Heavy-Duty Big Wheel® Cart

Suitable for industrial, commercial, and agricultural work.

- Strong, durable one-piece construction carries up to 700 lbs (FG564210)
- High-flotation, 8" wide wheels provide easy mobility over most surfaces
- Reinforced steel axle for heavy-duty hauling



FG564210

NO.	COLOR	DESCRIPTION	U.S. DIMENSIONS	U.S. LOAD	U.S. SIZE	U.S. SHIP WT/CTN	METRIC DIMENSIONS	METRIC LOAD	METRIC SIZE	METRIC SHIP WT/CTN	PACK
FG564210	BLA	7.5-Cu.-Ft. Heavy-Duty Big Wheel® Cart	57" l x 41" w x 26" h	700 lb	7.5 cu ft	55.0 lb	144.8 cm x 104.1 cm x 66 cm	317 kg	.21 m³	24.9 kg	1

Utility Lawn Carts

Designed to move loads quickly and easily.

- Easy to lift and dump; handle features molded-in tool/beverage holder
- Smooth interior is easy to clean
- FG370712 holds up to 3.25 cu ft (.09 m³) level capacity or 4.5 cu ft (.127 m³) heaped capacity
- FG370612 holds up to 4.5 cu ft (.127 m³) level capacity or 5.75 cu ft (.16 m³) heaped capacity



FG370612



FG370712907

NO.	COLOR	DESCRIPTION	U.S. DIMENSIONS	U.S. LOAD	U.S. SIZE	U.S. SHIP WT/CTN	METRIC DIMENSIONS	METRIC LOAD	METRIC SIZE	METRIC SHIP WT/CTN	PACK
FG370612	714	4.5-Cu.-Ft. Roughneck Lawn Cart, Green	48" l x 23.5" w x 28" h	200 lb	4.5 cu ft	235.9 lb	121.9 cm x 59.7 cm x 71.1 cm	90.7 kg	.13 m³	107.0 kg	12
FG370712	907	3.25-Cu.-Ft. Roughneck Lawn Cart, Platinum	42.5" l x 21" w x 28" h	200 lb	3.25 cu ft	195.6 lb	108 cm x 53.3 cm x 71.1 cm	90.7 kg	.09 m³	88.7 kg	12

UTILITY REFUSE AND RECYCLING

DECORATIVE REFUSE

CLEANING

MATERIAL HANDLING

WASHROOM

FOODSERVICE

ACCESSORIES & INDEX

BRUTE® Totes

The ultimate storage and transport container.

- Reinforced ribbed bottom protects container during dragging
- User-friendly grip handles decrease potential for back injury and finger strain
- Lid snaps tight, keeping contents secure



FG9S3000 / FG9S3100



FG9S3000 / FG440000

NO.	COLOR	DESCRIPTION	U.S. DIMENSIONS	U.S. CAPACITY	U.S. SHIP WT/CTN	METRIC DIMENSIONS	METRIC CAPACITY	METRIC SHIP WT/CTN	PACK
FG9S3000	WHT, GRAY	BRUTE® Tote with Lid	27.88" l x 16.5" w x 10.7" h	14 gal	46.0 lb	70.8 cm x 41.9 cm x 27.2 cm	53 L	20.9 kg	6
FG9S3100	WHT, GRAY	BRUTE® Tote with Lid	27.88" l x 17.38" w x 15.13" h	20 gal	53.0 lb	70.8 cm x 44.1 cm x 38.4 cm	75.7 L	24.0 kg	6

Stack and Nest Palletote® Boxes

For cost-effective storage and transportation.

- Fits 40" and 48" pallets with no overhang
- Nestable for efficient storage and transport, stackable with and without lids
- All plastic construction won't rust, dent, chip, or peel
- Rounded corners and smooth surfaces are easy to clean
- USDA 3A (Dairy) Sanitary Standards and Meat and Poultry Equipment Group Listed
- Slip-resistant, extended bottom
- Materials are FDA-compliant for food contact and certified to NSF Std. #2



FG172100



FG173100

NO.	COLOR	DESCRIPTION	U.S. DIMENSIONS	U.S. CAPACITY	U.S. SHIP WT/CTN	METRIC DIMENSIONS	METRIC CAPACITY	METRIC SHIP WT/CTN	PACK
FG172100	GRAY	Palletote® Box	19.5" l x 15.5" w x 10" h	1.3 cu ft	42.6 lb	49.5 cm x 39.4 cm x 25.4 cm	.04 m ³	19.3 kg	10
FG172200	GRAY	Palletote® Box	19.5" l x 15.5" w x 13" h	1.6 cu ft	57.9 lb	49.5 cm x 39.4 cm x 33.0 cm	.05 m ³	26.3 kg	10
FG173100	GRAY	Palletote® Box	23.5" l x 19.5" w x 10" h	2 cu ft	60.6 lb	59.7 cm x 49.5 cm x 25.4 cm	.06 m ³	27.5 kg	10

Lids

NO.	COLOR	DESCRIPTION	U.S. DIMENSIONS	U.S. CAPACITY	U.S. SHIP WT/CTN	METRIC DIMENSIONS	METRIC CAPACITY	METRIC SHIP WT/CTN	PACK
FG172000	GRAY	Palletote® Lid for FG172100, FG172200	19.63" l x 15.63" w x 1" h	N/A	16.1 lb	49.9 cm x 39.7 cm x 2.5 cm	N/A	7.3 kg	10
FG173000	GRAY	Palletote® Lid for FG173100	23.75" l x 19.75" w x 1" h	N/A	22.1 lb	60.3 cm x 50.2 cm x 2.5 cm	N/A	10.0 kg	10



UTILITY REFUSE
AND RECYCLING



WASHROOM

DECORATIVE REFUSE

CLEANING

MATERIAL HANDLING

WASHROOM

FOODSERVICE

ACCESSORIES
& INDEX



1980826/1955230



1938171/1903286

SKIN CARE

Counter Mount Touch-Free and Manual

AutoFoam with LumeCel™ Technology.....191
 OneShot® Soap Refills.....192
 OneShot® Foam Dispensers193
 OneShot® Enriched Foam Refills.....193
 OneShot® Liquid Dispensers.....194
 Manual Soap System.....194
 OneShot® Enriched Lotion Refills.....194

Wall Mount Touch-Free

AutoFoam Touch-Free Skin Care System.....195
 AutoFoam Enriched Foam Refills.....195

Wall Mount Manual

Flex™ Dispensers.....196
 Flex™ Enriched Foam and Lotion Refills.....197
 Manual Foam Dispensers and Refills198

AIR CARE

Aerosol

Microburst® 3000 Dispensers and Refills202
 Microburst® 9000 Dispensers and Refills204
 Microburst® Duet Dispensers and Refills205
 Standard Aerosol Dispensers and Refills206

Passive

TCell™ 1.0 Dispensers and Refills.....207

FIXTURES

AutoFaucet®.....211
 Auto Flush®212

SURFACE CARE

AutoClean®214
 Auto Janitor®214
 Clean Seat215

ACCESSORIES

Baby Changing Stations.....216
 Sanitary Bins217
 Sanitary Napkin Receptacles.....217
 Safti-Grip® Bath and Shower Mats217

WASHROOM



SKIN CARE

Rubbermaid Skin Care Systems provide customers with a comprehensive hygiene program of innovative product solutions to deliver superior personal, economic, and environmental health.



Personal Health

- Enjoyable experience encourages hand washing
- Cleaner hands protect health
- Better health means reduced absenteeism



Economic Health

- Efficient product systems lower operational costs
- Reliable systems and healthy employees improve productivity
- High-quality restroom products improve tenant retention



Environmental Health

- Green Seal™ certified soaps, safer for the environment
- Touch-free innovation helps earn LEED credits
- Reduced packaging for lower environmental impact

AutoFoam with LumeCel™ Technology

The LumeCel™ AutoFoam Touch-Free Skin Care System provides the highest quality foam soap in an attractive touch-free dispenser that is powered by the LumeCel™ rechargeable energy system.

- Like a solar panel capturing energy from the sun, LumeCel™ captures energy from any indoor or natural light source.
- No alkaline batteries required
- Touch-free delivery eliminates cross contamination to help reduce the spread of germs
- Contemporary "clean look" dispenser available in a variety of color combinations
- Refill level and battery life indicators
- ADA compliant force and one-handed operation
- Contributes to earning LEED credits



• NSF and • Green Seal apply to specific refills only; see below.



1980826



1980828



SMART

LumeCel stores energy from light, providing its own internal energy source.



SUSTAINABLE

LumeCel helps reduce your overall contribution of batteries to landfill waste.



EFFICIENT

Save time and money with LumeCel's rechargeable energy, requiring zero alkaline batteries.

AutoFoam Skin Care Dispensers and Retrofit Cover

NO.	DESCRIPTION	U.S. DIMENSIONS	U.S. SHIP WT/CASE	METRIC DIMENSIONS	METRIC SHIP WT/CASE	CASE PACK
1980826	AutoFoam Dispenser with LumeCel™ Technology – Black/Chrome	5.51" l x 5.51" w x 11.22" h	33.60 lb	14.0 cm x 14.0 cm x 28.5 cm	15.24 kg	10
1980827	AutoFoam Dispenser with LumeCel™ Technology – Black/Grey Pearl	5.51" l x 5.51" w x 11.22" h	33.60 lb	14.0 cm x 14.0 cm x 28.5 cm	15.24 kg	10
1980828	AutoFoam Dispenser with LumeCel™ Technology – White/Grey Pearl	5.51" l x 5.51" w x 11.22" h	33.60 lb	14.0 cm x 14.0 cm x 28.5 cm	15.24 kg	10
1980829	AutoFoam Dispenser with LumeCel™ Technology – Black/Black Pearl	5.51" l x 5.51" w x 11.22" h	33.60 lb	14.0 cm x 14.0 cm x 28.5 cm	15.24 kg	10
1980831	AutoFoam Dispenser with LumeCel™ Technology – White/Black Pearl	5.51" l x 5.51" w x 11.22" h	33.60 lb	14.0 cm x 14.0 cm x 28.5 cm	15.24 kg	10

Foam Hand Wash

NO.	DESCRIPTION	SIZE	U.S. SHIP WT/CASE	U.S. CASE CUBE	METRIC SHIP WT/CASE	METRIC CASE CUBE	CASE PACK
• FG750112	Enriched Foam Hand Soap with Moisturizers	1100 mL	10.9 lb	0.031 ft³	4.9 kg	0.01 m³	4
2018595	Enriched Foam Antibacterial Hand Wash — E2	1100 mL	10.4 lb	0.031 ft³	4.72 kg	0.01 m³	4

Foam Hand Sanitizer

NO.	DESCRIPTION	SIZE	U.S. SHIP WT/CASE	U.S. CASE CUBE	METRIC SHIP WT/CASE	METRIC CASE CUBE	CASE PACK
• 2080802	Enriched Foam Alcohol Hand Sanitizer — E3	1000 mL	10.8 lb	0.031 ft³	4.9 kg	0.01 m³	4
FG750593	Enriched Foam Alcohol-Free Hand Sanitizer	1100 mL	10.9 lb	0.031 ft³	4.9 kg	0.01 m³	4



OneShot® Soap Refills

Featuring premium-quality enriched lotion and enriched foam hand soaps for a luxurious hand washing experience that delights users and encourages healthy hand washing. These rich lathering soaps are formulated with extra-mild ingredients and enriched with effective moisturizers to leave hands feeling soft and refreshed. All soaps are pH-balanced and designed for frequent washing. Biodegradable and Green Seal™ certified soaps meet higher environmental standards.

Available OneShot® Formulations:

Green Certified Lotion Soap (Liquid)

- Green Seal™ certified
- Hypoallergenic for sensitive skin
- Fresh light honeysuckle fragrance
- Rich, white pearlized appearance
- Biodegradable



Free 'N Clean Soap (Liquid & Foam)

- Enriched with glycerin, silk proteins, aloe vera, & vitamin E
- Hypoallergenic for sensitive skin
- Dye-free and fragrance-free
- Biodegradable

Hand Soap with Moisturizers (Liquid & Foam)

- Enriched with glycerin, aloe vera, & vitamin E
- Hypoallergenic for sensitive skin
- Light passion flower fragrance
- Rich, teal pearlized appearance
- Biodegradable

Antibacterial Hand Wash (Liquid)

- Kills up to 99.99% of germs
- Hypoallergenic for sensitive skin
- Dermatologist-tested
- Light floral fragrance
- Dye-free
- Biodegradable

Up to
72%

more solids
than other soap systems

For a luxurious feeling they'll remember.



Up to
4x

more hand washes
than traditional bag-in-box soaps

Delivers the lowest cost in use in the industry.



Kills up to
99.99%

of germs
(antibacterial soap & sanitizer)

Keeps employees and guests healthy.



UTILITY REFUSE AND RECYCLING

DECORATIVE REFUSE

CLEANING

MATERIAL HANDLING

WASHROOM

FOODSERVICE

ACCESSORIES & INDEX



OneShot® Foam Dispensers

The OneShot® System sets the standard for quality and reliability in counter-mounted soap dispensing. Luxurious formulas encourage healthy hand washing, and Smart Sensor™ technology detects hands, automatically delivering the perfect amount of soap—every time!

- Touch-free delivery eliminates cross-contamination to help reduce the spread of germs
- Reliable, controlled dispensing of concentrated soaps eliminates over-use and costly waste
- Refill and battery-life indicator lights
- Industry-leading battery life (up to 3 years or 120,000 cycles for OneShot® liquid dispensers; up to 2 years or 90,000 cycles for OneShot® foam dispensers)
- No clogs, drips, or messy cleanup
- Closed dispensing system provides world-class reliability
- Programmable options for 800mL and 1600mL refills
- Helps earn LEED credits
- 0.8mL target dosage



NO.	DESCRIPTION	U.S. SHIP WT/CASE	U.S. CASE CUBE	METRIC SHIP WT/CASE	METRIC CASE CUBE	CASE PACK
1938171	OneShot® Foam Dispenser Low Profile — Polished Chrome	10.0 lb	1.20 ft³	4.50 kg	0.03 m³	4
FG4870465	OneShot® Foam Dispenser Low Profile Metal — Polished Chrome	12.0 lb	1.52 ft³	5.40 kg	0.04 m³	4
490071	OneShot® A/C Adapter	1.2 lb	0.17 ft³	0.50 kg	0.01 m³	1
490099	OneShot® 6V Adapter (bayonet)	0.3 lb	1.01 ft³	0.14 kg	0.03 m³	1
490100	OneShot® Adapter Wire (bayonet)	0.1 lb	1.50 ft³	0.06 kg	0.04 m³	1

OneShot® Enriched Foam Refills (for use with OneShot® Foam Dispensers)

More hand washes per refill reduce labor and soap costs (up to 2,000 hand washes per refill)

- High quality formulations enriched with moisturizers
- Boxless refill means 80% less packaging waste over bulk gallon
- Free 'N Clean soap is specially formulated for frequent hand washing and NSF E1 approved†
- Sealed refill eliminates potential for contamination
- Green Seal™* certified, biodegradable, and pH balanced formulas



● NSF and ● Green Seal apply to specific refills only; see below.



FG750517

FG750386

FG750389

FG750390

Enriched Foam Hand Wash Refills

NO.	DESCRIPTION	SIZE	U.S. SHIP WT/CASE	U.S. CASE CUBE	METRIC SHIP WT/CASE	METRIC CASE CUBE	CASE PACK
● FG750517	Enriched Foam Hand Soap with Moisturizers	800 mL	9.5 lb	0.35 ft³	4.3 kg	0.10 m³	4
● FG750386	Enriched Foam Hand Soap with Moisturizers	1600 mL	18.5 lb	0.62 ft³	8.4 kg	0.02 m³	4
● FG750389	Enriched Foam Free 'N Clean Soap — E1†	800 mL	9.5 lb	0.35 ft³	4.3 kg	0.10 m³	4
● FG750390	Enriched Foam Free 'N Clean Soap — E1†	1600 mL	18.5 lb	0.62 ft³	8.4 kg	0.02 m³	4

Use OneShot® Foam Dispensers only.

†NSF-approved E1 acceptable as a washing compound for use in establishments operating under the Federal meat, poultry, shell egg grading and egg products inspection programs.

*This product meets Green Seal™ Standard GS-41A based on effective performance and protective limits on VOCs and human & environmental toxicity. GreenSeal.org.





ADA COMPLIANT



FG401310



FG402073



FG401528



FG401832



FG402241



FG402243

SCAN FOR
INSTALLATION
VIDEOS



OneShot® Liquid Dispensers

NO.	DESCRIPTION	U.S. SHIP WT/CASE	U.S. CASE CUBE	METRIC SHIP WT/CASE	METRIC CASE CUBE	CASE PACK
FG401310	OneShot® Liquid Dispenser — Polished Chrome/Black	8.0 lb	1.15 ft³	3.63 kg	0.03 m³	4
FG402073	OneShot® Liquid Dispenser — Polished Chrome	8.0 lb	1.15 ft³	3.63 kg	0.03 m³	4
FG401528	OneShot® Liquid Dispenser — Brushed Chrome/Black	8.0 lb	1.15 ft³	3.63 kg	0.03 m³	4
FG401832	OneShot® Liquid Dispenser Metal Spout — Polished Chrome/Black	10.0 lb	1.15 ft³	4.50 kg	0.03 m³	4
FG402241	OneShot® Liquid Dispenser Low Profile — Polished Chrome	12.0 lb	1.15 ft³	5.40 kg	0.03 m³	4
FG402243	OneShot® Liquid Dispenser Low Profile Metal — Polished Chrome	12.0 lb	1.15 ft³	5.40 kg	0.03 m³	4
FG500394	OneShot® 800 mL Starter Kit (Chrome/Black Dispenser, Hand Wash Refill, 4 D Batteries)	6.0 lb	0.40 ft³	2.72 kg	0.01 m³	1
FG500449	OneShot® 1600 mL Starter Kit (Chrome/Black Dispenser, Hand Wash Refill, 4 D Batteries)	8.0 lb	0.40 ft³	3.63 kg	0.01 m³	1
490071	OneShot® A/C Adapter	1.2 lb	0.17 ft³	0.50 kg	0.01 m³	1
490099	OneShot® 6V Adapter (bayonet)	0.3 lb	1.01 ft³	0.14 kg	0.03 m³	1
490100	OneShot® Adapter Wire (bayonet)	0.1 lb	1.50 ft³	0.06 kg	0.04 m³	1

Manual Soap System

Attractive, manually operated counter-mounted dispensing system.



ADA COMPLIANT



FG401544

NO.	DESCRIPTION	U.S. SHIP WT/CASE	U.S. CASE CUBE	METRIC SHIP WT/CASE	METRIC CASE CUBE	CASE PACK
FG401544	Manual Liquid Dispenser — Polished Chrome	7.5 lb	0.79 ft³	3.40 kg	0.02 m³	12

**OneShot® Enriched Lotion Refills
(for use with OneShot® Liquid Dispensers)**

- More hand washes per refill reduce labor and soap costs (up to 2000 hand washes per refill)
- High-quality formulations enriched with moisturizers
- Sealed refill eliminates potential for contamination
- Wide choice of formulations including dye and fragrance-free, hypoallergenic, and antimicrobial options
- Green Seal™* certified lotion soap



FG4013131 / FG4015431

FG402363 / FG402364

FG4013111 / FG4015411

2018581 / 2018582



● Green Seal apply to specific refills only; see below.

NO.	DESCRIPTION	SIZE	U.S. SHIP WT/CASE	U.S. CASE CUBE	METRIC SHIP WT/CASE	METRIC CASE CUBE	CASE PACK
FG4013131	Green Seal Certified Lotion Soap	800 mL	9.0 lb	0.33 ft³	4.1 kg	0.01 m³	4
FG4015431	Green Seal Certified Lotion Soap	1600 mL	18.0 lb	0.50 ft³	8.2 kg	0.01 m³	4
FG402363	Enriched Lotion Free 'N Clean Soap	800 mL	9.0 lb	0.33 ft³	4.1 kg	0.01 m³	4
FG402364	Enriched Lotion Free 'N Clean Soap	1600 mL	18.0 lb	0.50 ft³	8.2 kg	0.01 m³	4
FG4013111	Enriched Lotion Hand Soap with Moisturizers	800 mL	9.0 lb	0.33 ft³	4.1 kg	0.01 m³	4
FG4015411	Enriched Lotion Hand Soap with Moisturizers	1600 mL	18.0 lb	0.50 ft³	8.2 kg	0.01 m³	4
2018581	Enriched Lotion Antibacterial Hand Wash	1600 mL	16.3 lb	0.55 ft³	7.4 kg	0.02 m³	4
2018582	Enriched Lotion Antibacterial Hand Wash	800 mL	8.50 lb	0.33 ft³	3.9 kg	0.01 m³	4

*This product meets Green Seal™ Standard GS-41A based on effective performance and protective limits on VOCs and human & environmental toxicity. GreenSeal.org.

AutoFoam Touch-Free Skin Care System
 Highest quality foam soap in an attractive touch-free dispenser delivers superior cost savings.

- Touch-free delivery eliminates cross contamination to help reduce the spread of germs
- Industry-leading battery life of 3 years or 120,000 hand washes*
- Contemporary "clean look" dispenser available in a variety of color combinations to enhance the image of any washroom décor
- Refill level and battery life indicators
- Boxless refill means 80% less packaging waste over bulk gallon
- ADA compliant force and one-handed operation
- Helps earn LEED credits
- 0.4mL target dosage



NO.	DESCRIPTION	U.S. DIMENSIONS	U.S. SHIP WT/CASE	U.S. CASE CUBE	METRIC DIMENSIONS	METRIC SHIP WT/CASE	METRIC CASE CUBE	CASE PACK
FG750127	AutoFoam Dispenser — Black/Black Pearl	5.25" l x 5.18" w x 10.86" h	24.75 lb	25.25 ft ³	13.3 cm x 13.2 cm x 27.6 cm	11.2 kg	0.72 m ³	10
FG750138	AutoFoam Dispenser — White/Black Pearl	5.25" l x 5.18" w x 10.86" h	24.75 lb	25.25 ft ³	13.3 cm x 13.2 cm x 27.6 cm	11.2 kg	0.72 m ³	10
FG750139	AutoFoam Dispenser — Black/Grey Pearl	5.25" l x 5.18" w x 10.86" h	24.75 lb	25.25 ft ³	13.3 cm x 13.2 cm x 27.6 cm	11.2 kg	0.72 m ³	10
FG750140	AutoFoam Dispenser — White/Grey Pearl	5.25" l x 5.18" w x 10.86" h	24.75 lb	25.25 ft ³	13.3 cm x 13.2 cm x 27.6 cm	11.2 kg	0.72 m ³	10
FG750411	AutoFoam Dispenser — Black/Chrome	5.25" l x 5.18" w x 10.86" h	24.75 lb	25.25 ft ³	13.3 cm x 13.2 cm x 27.6 cm	11.2 kg	0.72 m ³	10
1892265	AutoFoam Drip Tray	4.30" l x 3.90" w x 5.70" h	10.10 lb	0.44 ft ³	10.9 cm x 9.9 cm x 14.5 cm	4.60 kg	0.01 m ³	6

AutoFoam Enriched Foam Refills
 (for use with AutoFoam Dispensers)
 More hand washes per refill reduce labor and soap costs

- High capacity refill delivers up to 2,750 hand washes
- Moisture Enriched Foam hand sanitizers in alcohol and alcohol-free formulas that leave no sticky residue
- Hygienically sealed refills eliminate potential contamination
- Boxless refills evacuate fully to reduce waste
- Green Seal™* certified, biodegradable, and pH balanced hand soap
- Antibacterial foam soap kills 99.99% of germs; NSF Rated E2
- NSF E3-rated foam alcohol hand sanitizer formula



● NSF and ● Green Seal apply to specific refills only; see below.

Foam Hand Wash

NO.	DESCRIPTION	SIZE	U.S. SHIP WT/CASE	U.S. CASE CUBE	METRIC SHIP WT/CASE	METRIC CASE CUBE	CASE PACK
● FG750112	Enriched Foam Hand Soap with Moisturizers	1100 mL	10.9 lb	0.31 ft ³	4.9 kg	0.01 m ³	4
● 2018595	Enriched Foam Antibacterial Hand Wash — E2	1100 mL	10.4 lb	0.31 ft ³	4.72 kg	0.01 m ³	4

Foam Hand Sanitizer

NO.	DESCRIPTION	SIZE	U.S. SHIP WT/CASE	U.S. CASE CUBE	METRIC SHIP WT/CASE	METRIC CASE CUBE	CASE PACK
● 2080802	Enriched Foam Alcohol Hand Sanitizer — E3	1000 mL	10.8 lb	0.31 ft ³	4.9 kg	0.01 m ³	4
● FG750593	Enriched Foam Alcohol-Free Hand Sanitizer	1100 mL	10.9 lb	0.31 ft ³	4.9 kg	0.01 m ³	4



FLex™ Dispensers

FLex™ Skin Care System's revolutionary design allows you to use either foam or liquid refills in the same dispenser.

- Highest yield of hand washes—up to 3,250 per refill
- Signature Moisturizing Complex with shea butter, vitamin E, and panthenol
- Rich, dense lather and distinctive fragrances
- Accurate, adjustable, on-unit dose meter for effective portion control
- Superior "clean look" styling improves washroom aesthetics
- NSF-registered E2 and E3 formulas
- New 75% alcohol hand sanitizer kills over 99.99% of germs—E3-rated
- Unique alcohol-free hand sanitizer kills 99.99% of germs without alcohol—ideal for children (E3-rated)
- 2 sizes to meet any capacity, space, or installation requirement
- Hygienically sealed refills eliminate potential contamination
- Boxless refills evacuate fully to reduce waste
- 0.4, 0.65, 1.0 mL target dosage



The only system with adjustable portion control ON the dispenser — choose from 3 dose sizes: 0.4 mL – 0.65 mL – 1.0 mL.



FLex™ Skin Care Dispensers

NO.	DESCRIPTION	U.S. DIMENSIONS	U.S. SHIP WT/CASE	U.S. CASE CUBE	METRIC DIMENSIONS	METRIC SHIP WT/CASE	METRIC CASE CUBE	CASE PACK
3486589	Rubbermaid FLex™ Dispenser White — 500 mL	3.94" d x 5.00" w x 8.67" h	9.5 lb	1.36 ft³	10 cm x 12.7 cm x 22 cm	4.31 kg	0.04 m³	10
3486590	Rubbermaid FLex™ Dispenser Black — 500 mL	3.94" d x 5.00" w x 8.67" h	9.5 lb	1.36 ft³	10 cm x 12.7 cm x 22 cm	4.31 kg	0.04 m³	10
3486591	Rubbermaid FLex™ Dispenser White — 1000 mL, 1300 mL	3.94" d x 5.75" w x 11.73" h	13.7 lb	1.91 ft³	10 cm x 14.6 cm x 29.8 cm	6.23 kg	0.04 m³	10
3486592	Rubbermaid FLex™ Dispenser Black — 1000 mL, 1300 mL	3.94" d x 5.75" w x 11.73" h	13.7 lb	1.91 ft³	10 cm x 14.6 cm x 29.8 cm	6.23 kg	0.04 m³	10



Accessories

NO.	DESCRIPTION	U.S. SHIP WT/CASE	U.S. CASE CUBE	METRIC SHIP WT/CASE	METRIC CASE CUBE	CASE PACK
3486593*	Rubbermaid FLex™ Manual Dispenser Drip Tray — Grey	0.8 lb	0.29 ft³	0.36 kg	0.01 m³	6

* Dispenser not included

When ordering products with **BOLD** color codes, please specify color code after the product number. Refer to the Standard Color Guide at the back of the catalog.

UTILITY REFUSE AND RECYCLING

DECORATIVE REFUSE

CLEANING

MATERIAL HANDLING

WASHROOM

FOODSERVICE

ACCESSORIES & INDEX

FLex™ Enriched Foam Refills
(for use with FLex™ Dispensers)



● NSF and ● Green Seal apply to specific refills only; see below.



Foam Hand Wash & Body Shampoo

NO.	DESCRIPTION	SIZE	U.S. SHIP WT/CASE	U.S. CASE CUBE	METRIC SHIP WT/CASE	METRIC CASE CUBE	CASE PACK
● 3486561	Enriched Foam Hand Wash	500 mL	6.64 lb	0.41 ft ³	3.01 kg	0.01 m ³	5
● 3486571	Enriched Foam Hand Wash	1300 mL	9.75 lb	0.48 ft ³	4.42 kg	0.01 m ³	3
● 3486575	Enriched Foam Hand & Body Shampoo	1300 mL	9.74 lb	0.48 ft ³	4.42 kg	0.01 m ³	3
● 2018596	Enriched Foam Antibacterial Hand Wash — E2	1300 mL	9.92 lb	0.40 ft ³	4.50 kg	0.01 m ³	3

Foam Hand Sanitizers

NO.	DESCRIPTION	SIZE	U.S. SHIP WT/CASE	U.S. CASE CUBE	METRIC SHIP WT/CASE	METRIC CASE CUBE	CASE PACK
● 3486577	Enriched Foam Alcohol Plus Hand Sanitizer — E3	1000 mL	8.56 lb	0.48 ft ³	3.88 kg	0.01 m ³	3
● 3486579	Enriched Foam Alcohol-Free Plus Hand Sanitizer — E3	1300 mL	9.67 lb	0.48 ft ³	4.39 kg	0.01 m ³	3

FLex™ Enriched Lotion Refills
(for use with FLex™ Dispensers)



● NSF and ● Green Seal apply to specific refills only; see below.



NO.	DESCRIPTION	SIZE	U.S. SHIP WT/CASE	U.S. CASE CUBE	METRIC SHIP WT/CASE	METRIC CASE CUBE	CASE PACK
● 3486562	Enriched Lotion Hand Wash	500 mL	6.77 lb	0.41 ft ³	3.07 kg	0.01 m ³	5
● 3486572	Enriched Lotion Hand Wash	1300 mL	9.82 lb	0.48 ft ³	4.45 kg	0.01 m ³	3
3486576	Enriched Lotion Hand & Body Shampoo	1300 mL	10.15 lb	0.48 ft ³	4.60 kg	0.01 m ³	3

UTILITY REFUSE AND RECYCLING

DECORATIVE REFUSE

CLEANING

MATERIAL HANDLING

WASHROOM

FOODSERVICE

ACCESSORIES & INDEX



Manual Foam Dispensers and Refills

The perfect balance between quality and value.

- Metered pump provides controlled dose of high-density foam for 2,000 hand washes per refill
- Antimicrobial push bar
- Hygienic sealed refills keep soap fresh and clean
- Highly concentrated foam hand cleansers
- 0.4 mL target dosage



• NSF apply to specific refills only; see below.



1853755



FG450017



FG450034

Foam Skin Care Dispensers

NO.	DESCRIPTION	U.S. DIMENSIONS	U.S. SHIP WT/CASE	U.S. CASE CUBE	METRIC DIMENSIONS	METRIC SHIP WT/CASE	METRIC CASE CUBE	CASE PACK
FG450017	Foam Skin Care Dispenser 800 mL — White	5.25" l x 4.75" w x 9.75" h	1.3 lb	2.04 ft ³	13.3 cm x 12.1 cm x 24.8 cm	0.6 kg	0.06 m ³	10
FG450034	Foam Skin Care Dispenser 800 mL — Black	5.25" l x 4.75" w x 9.75" h	1.0 lb	2.17 ft ³	13.3 cm x 12.1 cm x 24.8 cm	0.5 kg	0.06 m ³	10
1853755	Foam Skin Care Dispenser 800 mL — Stainless	5.51" l x 4.92" w x 10.63" h	1.3 lb	2.04 ft ³	14 cm x 12.5 cm x 27 cm	0.6 kg	0.06 m ³	10



FG450019



2018598



FG751001



FG750592

Enriched Foam Hand Wash Refills (for use with Manual Foam Dispenser)

NO.	DESCRIPTION	SIZE	U.S. SHIP WT/CASE	U.S. CASE CUBE	METRIC SHIP WT/CASE	METRIC CASE CUBE	CASE PACK
FG450019	Foam Hand Soap with Moisturizers	800 mL	12.8 lb	0.33 ft ³	5.8 kg	0.01 m ³	6
2018598	Foam Antibacterial Hand Wash — E2	800 mL	12.4 lb	0.34 ft ³	5.8 kg	0.01 m ³	6

Enriched Foam Hand & Body Wash Refills (for use with Manual Foam Dispenser)

NO.	DESCRIPTION	SIZE	U.S. SHIP WT/CASE	U.S. CASE CUBE	METRIC SHIP WT/CASE	METRIC CASE CUBE	CASE PACK
FG751001	Foam Hand & Body Wash	800 mL	12.8 lb	0.33 ft ³	5.8 kg	0.01 m ³	6

Enriched Foam Hand Sanitizers (for use with Manual Foam Dispenser)

NO.	DESCRIPTION	SIZE	U.S. SHIP WT/CASE	U.S. CASE CUBE	METRIC SHIP WT/CASE	METRIC CASE CUBE	CASE PACK
FG750592	Foam Alcohol-Free Hand Sanitizer	800 mL	12.8 lb	0.33 ft ³	5.8 kg	0.01 m ³	6
2080803	Foam Alcohol Hand Sanitizer	1000 mL	10.8 lb	0.39 ft ³	4.9 kg	0.01 m ³	4



1980826



AIR CARE

Rubbermaid Air Care Systems ensure that the first things you and your customers notice when you enter your washroom is a clean, fresh, and pleasant fragrance.

By combining innovative and reliable dispensing technologies with our select fragrances, our automated air care systems are highly cost-efficient and long-lasting, delivering consistent and continuous freshness, and offering the perfect solution to suit your specific washroom needs.



FLORAL

Characterized by radiant notes such as rose, jasmine, violet; green notes which are reminiscent of freshly cut grass, leaves, and stems.



FRUITY

Characterized by luscious fruity notes such as apple, pear, plum, mango, peach, and melon.



CITRUS

Characterized by invigorating & uplifting notes such as lemon, mandarin, and other citrus oils.



HERBAL

Characterized by powerful, aromatic herbal notes such as rosemary, mint, coriander, lavender, and sage.



FOUGÈRE

Characterized by masculine notes such as lavender, moss, and woods.



GOURMAND

Characterized by mouthwatering, edible notes and sweet, comforting vanilla.

AVAILABLE FRAGRANCES

FLORAL:

Cotton Berry
Country Delight™
Cucumber Melon
Island Melon
Sea Mist
Summer Sorbet
Wakening Spring

FRUITY:

Cherry Berry
Cucumber Melon
Delicious Apple
Gentle Breeze
Mango
Mango Blossom
Mountain Peaks
Mountain Spa™
Orchard Fields
Tropical Sunrise
Tropix

CITRUS:

Citrus
Green Tea
Lemon
Mandarin Orange
Refreshing Citrus

HERBAL:

Crystal Breeze
Ocean Breeze
Polar Mist
Santa Fe

FOUGÈRE:

Alpine Spring
Blue Splash
Linen Fresh™

GOURMAND:

Apple Cinnamon
Cinnamon Spice
Sugar Cookie
Vanilla
Vanilla Coconut
Vanilla Crème
Vanilla Royale

FRAGRANCE INTENSITY

Aerosol Fragrances

Microburst® 3000 & Microburst® 9000

Linen Fresh™	Vanilla Royale	Mango	Ocean Breeze	Cucumber Melon	Mountain Peaks	Green Tea	Cinnamon Spice	Orchard Fields	Blue Splash	Mandarin Orange	Country Delight™
--------------	----------------	-------	--------------	----------------	----------------	-----------	----------------	----------------	-------------	-----------------	------------------

MILD INTENSE

Microburst® Duet

Gentle Breeze	Linen	Ocean Breeze	Sea Mist	Alpine Spring	Mountain Peaks	Cotton Berry	Refreshing Citrus
---------------	-------	--------------	----------	---------------	----------------	--------------	-------------------

MILD INTENSE

Standard Aerosol

Linen Fresh™	Vanilla Royale	Mango	Ocean Breeze	Mountain Peaks	Cinnamon Spice	Delicious Apple	Orchard Fields	Blue Splash	Mandarin Orange	Country Delight™	Lemon
--------------	----------------	-------	--------------	----------------	----------------	-----------------	----------------	-------------	-----------------	------------------	-------

MILD INTENSE

Non-Aerosol Fragrances

Pump Odor Control

Linen Fresh™	Vanilla	Ocean Breeze	Mountain Spa™	Santa Fe	Tropix	Country Delight™
--------------	---------	--------------	---------------	----------	--------	------------------

MILD INTENSE

Gel Odor Control

Linen Fresh™	Vanilla Coconut	Ocean Breeze	Island Melon	Delicious Apple	Mandarin Orange	Cherry Berry	Country Delight™
--------------	-----------------	--------------	--------------	-----------------	-----------------	--------------	------------------

MILD INTENSE

TCell™ Odor Control

Wakening Spring	Polar Mist	Blue Splash	Crystal Breeze	Citrus	Mango Blossom	Cucumber Melon	Tropical Sunrise	Summer Sorbet	Pure™ Odor Neutralizer	Vanilla Crème	Sugar Cookie	Apple Cinnamon
-----------------	------------	-------------	----------------	--------	---------------	----------------	------------------	---------------	------------------------	---------------	--------------	----------------

MILD INTENSE

Microtrans® Technology

Traditional air fresheners only camouflage malodors. Rubbermaid Commercial Products Air Care Systems are engineered to do the complete job! All RCP formulas contain Microtrans®, a true odor neutralizer, which is paired with the industry's highest quality fragrances to effectively eliminate "unavoidable odors" in commercial washrooms. And it contains 63% fewer VOCs per spray than standard aerosol.

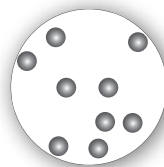

Unavavoidable odors creating an unpleasant restroom environment

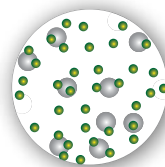

Microtrans® penetrating and soaking into malodor particles

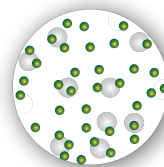

Microtrans® transforming malodors into a neutral base

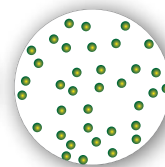

Creating a fresh, hygienic, and comfortable restroom environment

Microburst® 3000 with LumeCel™ Technology

Battery-Free Dispensing Systems

- Rubbermaid Commercial Products introduces a revolutionary new technology to air care—the Microburst® 3000, powered by the LumeCel™ rechargeable energy system.
- With easy, flexible programming, and world-class reliability, the Microburst® 3000 offers an effective air freshening system that is now better and safer for the environment.



63%
FEWER VOCs
PER SPRAY
than standard aerosol

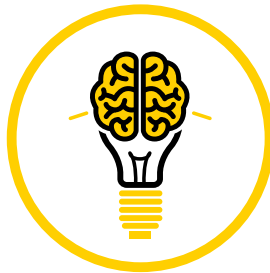

SMART

LumeCel stores energy from light, providing its own internal energy source.



SUSTAINABLE

LumeCel helps reduce your overall contribution of batteries to landfill waste.



EFFICIENT

Save time and money with LumeCel's rechargeable energy, requiring zero alkaline batteries.



Scan for General Information



Scan for Video



1955228



1955229



1955230

Microburst® 3000 Dispensers with LumeCel™ Technology (See page 203 for refills).

NO.	DESCRIPTION	U.S. DIMENSIONS	U.S. SHIP WT/CASE	METRIC DIMENSIONS	METRIC SHIP WT/CASE	CASE PACK
1955228	Microburst® 3000 Dispenser with LumeCel™ Technology — Black	4.75" w x 8" h x 5" l	7.8 lb	12.06 cm x 20.32 cm x 12.7 cm	3.5 kg	6
1955229	Microburst® 3000 Dispenser with LumeCel™ Technology — White	4.75" w x 8" h x 5" l	7.8 lb	12.06 cm x 20.32 cm x 12.7 cm	3.5 kg	6
1955230	Microburst® 3000 Dispenser with LumeCel™ Technology — Chrome	4.75" w x 8" h x 5" l	7.8 lb	12.06 cm x 20.32 cm x 12.7 cm	3.5 kg	6

UTILITY REFUSE AND RECYCLING

DECORATIVE REFUSE

CLEANING

MATERIAL HANDLING

WASHROOM

FOODSERVICE

ACCESSORIES & INDEX

Microburst® 3000 Aerosol Odor Control Systems

Delivering a cost-effective solution, with all the power, performance, and flexibility in half the size of standard dispensers, 3,000 sprays per refill. Smaller refills require less storage space and produce less waste.



BATTERY GAUGE
Shows battery life; battery lasts up to 36 months*
3000 – 2 C Cell
9000 – 2 D Cell

REFILL INDICATOR
Shows days remaining before refills need to be changed; refills last up to 168 days for 3000 dispensers, and up to 180 days for 9000 dispensers.

ALARM SYMBOL
Optional audio tone indicates need to change batteries and refill.

FLEXIBLE PROGRAMMING
Options include 12 / 24 hours per day and 5, 6, or 7 days per week.

MICROBURST® 3000 SYSTEM
Combines great looks with low-cost, effective performance.

1793533



1793531



1793532

Microburst® 3000 Dispensers*

NO.	DESCRIPTION	U.S. DIMENSIONS	U.S. SHIP WT/CASE	U.S. CASE CUBE	METRIC DIMENSIONS	METRIC SHIP WT/CASE	METRIC CASE CUBE	CASE PACK
1793531	Microburst® 3000 LCD Dispenser — Black	3.25" w x 6.63" h	6.0 lb	0.28 ft³	8.26 cm x 16.83 cm	2.7 kg	0.09 m³	6
1793532	Microburst® 3000 LCD Dispenser — White	3.25" w x 6.63" h	6.0 lb	0.28 ft³	8.26 cm x 16.83 cm	2.7 kg	0.09 m³	6
1793533	Microburst® 3000 LCD Dispenser — Chrome	3.25" w x 6.63" h	6.0 lb	0.28 ft³	8.26 cm x 16.83 cm	2.7 kg	0.09 m³	6
FG401442	Microburst® 3000 Economizer Dispenser — White	3.25" w x 6.63" h	6.0 lb	0.28 ft³	8.26 cm x 16.83 cm	2.7 kg	0.09 m³	6

*Requires 2 "C" alkaline batteries (not included)

Microburst® 3000 Refills

Microtrans® Odor Neutralizer breaks down and eliminates malodors.

- Contains 63% fewer VOCs per spray than a standard aerosol
- Refill actuator distributes the finest dry mist for long-lasting performance
- All refills contain Microtrans® Odor Neutralizer



FG4012551 FG4012561 FG4012571 FG4012591 FG4012581

Microburst® 3000 Refills*

NO.	DESCRIPTION	FRAGRANCE FAMILY	U.S. SHIP WT/CASE	U.S. CASE CUBE	METRIC SHIP WT/CASE	METRIC CASE CUBE	CASE PACK
FG4012551	Microburst® 3000 Refill — Linen Fresh™	Fougère	3.0 lb	0.14 ft³	1.4 kg	0.04 m³	12
FG4012561	Microburst® 3000 Refill — Orchard Fields	Fruity	3.0 lb	0.14 ft³	1.4 kg	0.04 m³	12
FG4012571	Microburst® 3000 Refill — Mountain Peaks	Fruity	3.0 lb	0.14 ft³	1.4 kg	0.04 m³	12
FG4012591	Microburst® 3000 Refill — Country Delight™	Floral	3.0 lb	0.14 ft³	1.4 kg	0.04 m³	12
FG4012581	Microburst® 3000 Refill — Ocean Breeze	Herbal	3.0 lb	0.14 ft³	1.4 kg	0.04 m³	12
FG401689	Microburst® 3000 Refill — Cinnamon Spice	Gourmand	3.0 lb	0.14 ft³	1.4 kg	0.04 m³	12
FG401690	Microburst® 3000 Refill — Mango	Fruity	3.0 lb	0.14 ft³	1.4 kg	0.04 m³	12
FG401691	Microburst® 3000 Refill — Vanilla Royale	Gourmand	3.0 lb	0.14 ft³	1.4 kg	0.04 m³	12
FG402355	Microburst® 3000 Refill — Blue Splash	Fougère	3.0 lb	0.14 ft³	1.4 kg	0.04 m³	12
FG402408	Microburst® 3000 Refill — Mandarin Orange	Citrus	3.0 lb	0.14 ft³	1.4 kg	0.04 m³	12
FG750362	Microburst® 3000 Refill — Green Tea	Citrus	3.0 lb	0.14 ft³	1.4 kg	0.04 m³	12
FG750363	Microburst® 3000 Refill — Cucumber Melon	Fruity	3.0 lb	0.14 ft³	1.4 kg	0.04 m³	12
FG401260A*	Microburst® 3000 Refill — Preference Pack	—	3.0 lb	0.14 ft³	1.4 kg	0.04 m³	1 (10)

*401260A Preference Pack contains 2 refills each of Linen Fresh™, Orchard Fields, Mountain Peaks, Country Delight™, and Ocean Breeze.



Microburst® 9000 Dispensers and Refills

The lowest cost in-use odor control system available. Microburst® refills contain 63 percent fewer VOCs per spray than a standard aerosol.

- The patented refill actuator distributes the finest dry mist for long lasting performance. The Microburst® 9000 system maximizes cost control while providing greater coverage and long-lasting odor neutralizing and fragrancing
- One 9000 refill will replace 3 standard aerosol refills
- All of the features of Microburst® 3000, but delivers three times the odor control and fragrance



LCD Programming options
 up to 180 days
 12 / 24 hr
 5 / 6 / 7 days per week

Economizer Programming options
 90 days
 24 hr
 7 days per week



1793535

MICROBURST® 9000 SYSTEM

Maximizes cost control while providing greater coverage and long-lasting odor neutralizing and fragrances.



1793534

1793535

Microburst® 9000 Dispensers*

NO.	DESCRIPTION	U.S. DIMENSIONS	U.S. SHIP WT/CASE	U.S. CASE CUBE	METRIC DIMENSIONS	METRIC SHIP WT/CASE	METRIC CASE CUBE	CASE PACK
1793534	Microburst® 9000 LCD Dispenser — Black	3.56" w x 8.75" h	7.0 lb	0.46 ft³	9.04 cm x 22.23 cm	3.2 kg	0.14 m³	6
1793535	Microburst® 9000 LCD Dispenser — White	3.56" w x 8.75" h	7.0 lb	0.46 ft³	9.04 cm x 22.23 cm	3.2 kg	0.14 m³	6
1793536	Microburst® 9000 LCD Dispenser — Chrome	3.56" w x 8.75" h	7.0 lb	0.46 ft³	9.04 cm x 22.23 cm	3.2 kg	0.14 m³	6
FG401375	Microburst® 9000 Economizer Dispenser — White	3.56" w x 8.75" h	7.0 lb	0.46 ft³	9.04 cm x 22.23 cm	3.2 kg	0.14 m³	6

*Requires 2 "D" alkaline batteries (not included).

Microburst® 9000 Refills

Microtrans® Odor Neutralizer breaks down and eliminates malodors.

- Contains 63% fewer VOCs per spray than a standard aerosol
- Refill actuator distributes the finest dry mist for long-lasting performance

9000 METERED SPRAYS



DELIVERING COST EFFECTIVE CUSTOMER DELIGHT

One 9000 refill will replace three standard refills – 90 to 180 days of maximum odor control from one refill. This also allows for less packaging per spray.

Microburst® 9000 Refills

NO.	DESCRIPTION	FRAGRANCE FAMILY	U.S. SHIP WT/CASE	U.S. CASE CUBE	METRIC SHIP WT/CASE	METRIC CASE CUBE	CASE PACK
FG4012441	Microburst® 9000 Refill — Linen Fresh™	Fougère	3.0 lb	0.16 ft³	1.4 kg	0.05 m³	4
FG4012451	Microburst® 9000 Refill — Orchard Fields	Fruity	3.0 lb	0.16 ft³	1.4 kg	0.05 m³	4
FG4012461	Microburst® 9000 Refill — Mountain Peaks	Fruity	3.0 lb	0.16 ft³	1.4 kg	0.05 m³	4
FG4012481	Microburst® 9000 Refill — Country Delight™	Floral	3.0 lb	0.16 ft³	1.4 kg	0.05 m³	4
FG4012471	Microburst® 9000 Refill — Ocean Breeze	Herbal	3.0 lb	0.16 ft³	1.4 kg	0.05 m³	4
FG401692	Microburst® 9000 Refill — Cinnamon Spice	Gourmand	3.0 lb	0.16 ft³	1.4 kg	0.05 m³	4
FG401693	Microburst® 9000 Refill — Mango	Fruity	3.0 lb	0.16 ft³	1.4 kg	0.05 m³	4
FG401694	Microburst® 9000 Refill — Vanilla Royale	Gourmand	3.0 lb	0.16 ft³	1.4 kg	0.05 m³	4
FG402354	Microburst® 9000 Refill — Blue Splash	Fougère	3.0 lb	0.16 ft³	1.4 kg	0.05 m³	4
FG402093	Microburst® 9000 Refill — Mandarin Orange	Citrus	3.0 lb	0.16 ft³	1.4 kg	0.05 m³	4
FG750366	Microburst® 9000 Refill — Cucumber Melon	Fruity	3.0 lb	0.16 ft³	1.4 kg	0.05 m³	4
FG4012491*	Microburst® 9000 Refill — Preference Pack	—	4.0 lb	0.16 ft³	1.8 kg	0.05 m³	1 (5)

*4012491 Preference Pack contains 1 refill each of Linen Fresh™, Orchard Fields, Mountain Peaks, Country Delight™, and Ocean Breeze.

Microburst® Duet Dispensers and Refills

Dual-fragrance odor control system.

- Automatically alternates between two complementary scents for renewed freshness you will notice every day

2 fragrances are better than **1**

DUAL FRAGRANCES

Alternates between two complementary scents, eliminates fragrance fatigue, and keeps rooms fresh and pleasant.

Year Warranty
10

Fully Guaranteed Against Defects in Parts and Workmanship



FG4870055

DISPENSER LOCK



FLEXIBLE PROGRAMMING

You decide which fragrance will spray, and when. Alternates fragrances:

- Hour to Hour
- AM / PM
- Day to Day



63%

fewer VOCs per spray than standard aerosol

Microburst® Duet Dispensers

Dual-fragrance odor control system.

- Alternating scents eliminate fragrance fatigue
- Programmable freshness
- Cost-effective solution
- High-quality, customer-preferred refill fragrances
- Use with Microburst® Duet Refills
- Requires 2 "C" alkaline batteries (not included)



FG4870001



FG4870002



FG4870055



FG4870056

Microburst® Duet Dispensers

NO.	DESCRIPTION	U.S. DIMENSIONS	U.S. SHIP WT/CASE	U.S. CASE CUBE	METRIC DIMENSIONS	METRIC SHIP WT/CASE	METRIC CASE CUBE	CASE PACK
FG4870001	Microburst® Duet Dispenser – White/Grey Pearl	4.96" w x 8.62" h	24.8 lb	2.36 ft³	12.6 cm x 21.89 cm	11.2 kg	0.072 m³	6
FG4870002	Microburst® Duet Dispenser – Black/Black Pearl	4.96" w x 8.62" h	24.8 lb	2.36 ft³	12.6 cm x 21.89 cm	11.2 kg	0.072 m³	6
FG4870055	Microburst® Duet Dispenser – Black/Chrome	4.96" w x 8.62" h	24.8 lb	2.36 ft³	12.6 cm x 21.89 cm	11.2 kg	0.072 m³	6
FG4870056	Microburst® Duet Dispenser – White/White	4.96" w x 8.62" h	24.8 lb	2.36 ft³	12.6 cm x 21.89 cm	11.2 kg	0.072 m³	6

Microburst® Duet Refills

Specially selected complementary fragrances.

- Each refill features a unique combination of exclusive aromas
- High-quality fragrance oils dispensed through Microburst® technology for longer-lasting performance
- All refills contain Microtrans® odor neutralizer
- Use with Microburst® Duet dispensers



Gentle Breeze / Linen Fresh™
3485949



Alpine Spring / Mountain Peaks
3485950



Ocean Breeze / Sea Mist
3485951



Cotton Berry / Refreshing Citrus
3485952

Microburst® Duet Refills

NO.	DESCRIPTION	FRAGRANCE FAMILY	U.S. SHIP WT/CASE	U.S. CASE CUBE	METRIC SHIP WT/CASE	METRIC CASE CUBE	CASE PACK
3485949	Microburst® Duet – Gentle Breeze/Linen Fresh™	Fruity/Fougere	10.85 lb	0.024 ft³	4.9 kg	0.01 m³	4
3485950	Microburst® Duet – Alpine Spring/Mountain Peaks	Fougere/Fruity	10.85 lb	0.024 ft³	4.9 kg	0.01 m³	4
3485951	Microburst® Duet – Ocean Breeze/Sea Mist	Floral/Herbal	10.85 lb	0.024 ft³	4.9 kg	0.01 m³	4
3485952	Microburst® Duet – Cotton Berry/Refreshing Citrus	Floral/Citrus	10.85 lb	0.024 ft³	4.9 kg	0.01 m³	4
3486092	Microburst® Duet – Variety Pack (1 of ea. refill)	–	10.85 lb	0.024 ft³	4.9 kg	0.01 m³	1 (4)



Standard Aerosol Dispensers and Refills

Standard Aerosol System offers automatic odor control for every budget.

- Smart chip technology maximizes odor control effectiveness for 30 to 168 days
- LCD model features adjustable spray intervals of 7, 14, or 28 minutes; 12/24 hours per day; or 5, 6, or 7 days per week
- LED model features adjustable spray intervals from 5 to 25 minutes and service intervals of 30, 45, or 60 days
- All refills contain Microtrans® Odor Neutralizer



1793541

Standard Aerosol System Dispensers

NO.	DESCRIPTION	U.S. DIMENSIONS	U.S. SHIP WT/CASE	U.S. CASE CUBE	METRIC DIMENSIONS	METRIC SHIP WT/CASE	METRIC CASE CUBE	CASE PACK
1793541	Standard Aerosol LCD Dispenser — White	3.56" w x 8.75" h	7.0 lb	0.46 ft³	9.04 cm x 22.23 cm	3.2 kg	0.14 m³	6
FG400868	Standard Aerosol Economizer — White	3.56" w x 8.75" h	7.0 lb	0.46 ft³	9.04 cm x 22.23 cm	3.2 kg	0.14 m³	6

*Requires 2 "D" alkaline batteries (not included)



FG4009831 / FG4015471 / FG4009851 / FG4009841 / FG4015061

Standard Aerosol System Refills

NO.	DESCRIPTION	FRAGRANCE FAMILY	U.S. SHIP WT/CASE	U.S. CASE CUBE	METRIC SHIP WT/CASE	METRIC CASE CUBE	CASE PACK
FG4009831	Standard Aerosol — Linen Fresh™	Fougère	9.0 lb	0.31 ft³	4.1 kg	0.09 m³	12
FG4009841	Standard Aerosol — Orchard Fields	Fruity	9.0 lb	0.31 ft³	4.1 kg	0.09 m³	12
FG4009851	Standard Aerosol — Mountain Peaks	Fruity	9.0 lb	0.31 ft³	4.1 kg	0.09 m³	12
FG4015061	Standard Aerosol — Country Delight™	Floral	9.0 lb	0.31 ft³	4.1 kg	0.09 m³	12
FG4015471	Standard Aerosol — Ocean Breeze	Herbal	9.0 lb	0.31 ft³	4.1 kg	0.09 m³	12
FG400573	Standard Aerosol — Vanilla Royale	Gourmand	9.0 lb	0.31 ft³	4.1 kg	0.09 m³	12
FG400696	Standard Aerosol — Cinnamon Spice	Gourmand	9.0 lb	0.31 ft³	4.1 kg	0.09 m³	12
FG401503	Standard Aerosol — Delicious Apple	Fruity	9.0 lb	0.31 ft³	4.1 kg	0.09 m³	12
FG401504	Standard Aerosol — Mandarin Orange	Citrus	9.0 lb	0.31 ft³	4.1 kg	0.09 m³	12
FG401695	Standard Aerosol — Mango	Fruity	9.0 lb	0.31 ft³	4.1 kg	0.09 m³	12
FG401909	Standard Aerosol — Lemon	Citrus	9.0 lb	0.31 ft³	4.1 kg	0.09 m³	12
FG401231*	Standard Aerosol — Preference Pack	—	8.5 lb	0.31 ft³	3.9 kg	0.09 m³	1 (10)

*401260A Preference Pack contains 2 refills each of Linen Fresh™, Orchard Fields, Mountain Peaks, Country Delight™, and Ocean Breeze.

TCell™ 1.0 Dispensers and Refills

Utilizing its patented fluid delivery system, TCell™ fuel cell technology delivers a precise dose of a wide variety of fragrances for 60 or 90 days without the use of batteries. Environmentally friendly system contains no propellants or added VOCs.

- Precision dosing delivery system; one dispenser covers approximately 3 to 4 stalls/fixtures (6,000 cubic feet)
- Sleek, attractive dispenser design will fit any décor
- Passive dispenser requires no batteries and operates silently



LIFETIME WARRANTY
Fully guaranteed against defects of parts and workmanship.



1793548

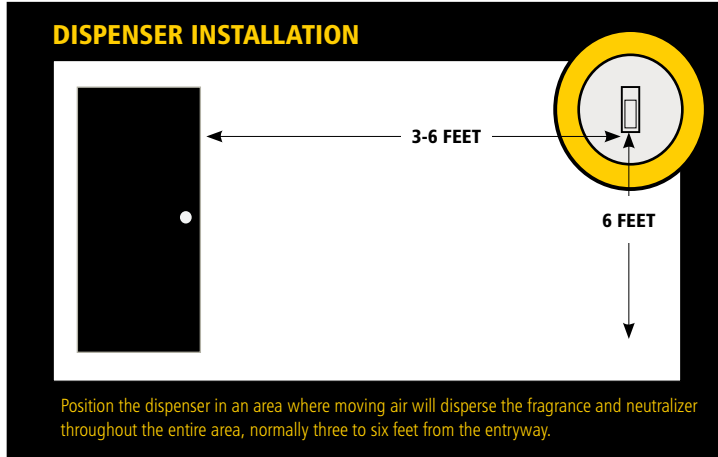

TCell™ Dispensers

NO.	DESCRIPTION	U.S. DIMENSIONS	U.S. SHIP WT/CASE	U.S. CASE CUBE	METRIC DIMENSIONS	METRIC SHIP WT/CASE	METRIC CASE CUBE	CASE PACK
1793546	TCell™ Dispenser — Black	2.8" w x 5.37" h	3.5 lb	0.44 ft³	7.11 cm x 13.63 cm	1.6 kg	0.13 m³	12
1793547	TCell™ Dispenser — White	2.8" w x 5.37" h	3.5 lb	0.44 ft³	7.11 cm x 13.63 cm	1.6 kg	0.13 m³	12
1793548	TCell™ Dispenser — Chrome	2.8" w x 5.37" h	3.5 lb	0.44 ft³	7.11 cm x 13.63 cm	1.6 kg	0.13 m³	12

TCell™ Refills

The TCell™ odor control system dispenses a consistent level of fragrance.

- Up to 33% refill source reduction over traditional 30 day systems
- Standard setting: 60 Days — Standard Size Washroom: 3 to 4 stalls/fixtures
- Light setting: 90 Days — Smaller Size Washroom: 1 to 2 stalls/fixtures
- Recyclable refill components



TCell™ Refills

NO.	DESCRIPTION	FRAGRANCE FAMILY	U.S. SHIP WT/CASE	U.S. CASE CUBE	METRIC SHIP WT/CASE	METRIC CASE CUBE	CASE PACK
FG402110	TCell™ Refill — Wakening Spring	Floral	2.0 lb	0.11 ft³	0.9 kg	0.03 m³	6
FG402111	TCell™ Refill — Polar Mist	Herbal	2.0 lb	0.11 ft³	0.9 kg	0.03 m³	6
FG402112	TCell™ Refill — Blue Splash	Fougère	2.0 lb	0.11 ft³	0.9 kg	0.03 m³	6
FG402187	TCell™ Refill — Crystal Breeze	Herbal	2.0 lb	0.11 ft³	0.9 kg	0.03 m³	6
FG402113	TCell™ Refill — Citrus	Citrus	2.0 lb	0.11 ft³	0.9 kg	0.03 m³	6
FG402369	TCell™ Refill — Mango Blossom	Fruity	2.0 lb	0.11 ft³	0.9 kg	0.03 m³	6
FG402470	TCell™ Refill — Cucumber Melon	Fruity	2.0 lb	0.11 ft³	0.9 kg	0.03 m³	6
FG402472	TCell™ Refill — Tropical Sunrise	Fruity	2.0 lb	0.11 ft³	0.9 kg	0.03 m³	6
FG402473	TCell™ Refill — Summer Sorbet	Floral	2.0 lb	0.11 ft³	0.9 kg	0.03 m³	6
FG402498	TCell™ Refill — Pure™ Odor Neutralizer	—	2.0 lb	0.11 ft³	0.9 kg	0.03 m³	6
FG750905	TCell™ Refill — Vanilla Crème	Gourmand	2.0 lb	0.11 ft³	0.9 kg	0.03 m³	6
FG750537	TCell™ Refill — Sugar Cookie	Gourmand	2.0 lb	0.11 ft³	0.9 kg	0.03 m³	6
FG750907	TCell™ Refill — Cinnamon Spice	Gourmand	2.0 lb	0.11 ft³	0.9 kg	0.03 m³	6
FG402236*	TCell™ Refill Preference Pack	—	2.0 lb	0.11 ft³	0.9 kg	0.03 m³	1 (5)

*FG402236 Preference Pack contains one refill each of Wakening Spring, Polar Mist, Blue Splash, Citrus, and Crystal Breeze.



AutoFaucet®

AutoFaucet® sets the standard for reliability and user-friendly performance in automated faucet systems. Equipped with Surround Sensor™ Technology, AutoFaucet® delivers water only when needed, resulting in water savings of up to 70 percent.

- Touch-free activation eliminates cross-contamination to help reduce the spread of germs
- Surround Sensor™ technology creates a 3" omnidirectional sensing zone, guaranteeing activation every time
- AutoFaucet® is low-lead-compliant
- "Dry" cam-gear technology (solenoid valve-free) ensures trouble-free operation to reduce maintenance
- Long battery life—400,000 cycles or 3 years (4 "D" batteries included)
- Also available with optional AC power adapter
- Standard 0.5 gpm aerator helps conserve water and reduce negative impact on the environment



ADA COMPLIANT



Certified by IAMPO R&T for compliance with Lead Plumbing Law

UP TO
70%
water savings



Surround Sensor™ Technology creates a 3" omnidirectional sensing zone, guaranteeing activation every time.



MILANO



VERONA

UTILITY REFUSE AND RECYCLING

DECORATIVE REFUSE

CLEANING

MATERIAL HANDLING

WASHROOM

FOODSERVICE

ACCESSORIES & INDEX



Improve Health & Wellness

Away-from-home washroom patrons prefer touch-free fixtures and are 50% more likely to wash their hands. AutoFaucet® effortlessly provides reliable, touch-free activation every time to encourage, rather than discourage, frequent use and to eliminate this critical touch point of germs in washrooms.



Sustainable Design

AutoFaucet® delivers water only when needed to save up to 70% water savings and earn LEED credits. AutoFaucet® systems' dry cam-gear technology requires less energy to operate, providing exceptional battery life for over 400,000 hand washes (AC power option available).



World-Class Reliability

Patented dry cam-gear technology controls water flow with world-class reliability. The absence of solenoid valves avoids costly repairs and ensures worry-free operation by keeping electronic components separate from water flow.

OPTIONAL THERMOSTATIC MIXING VALVE

Guarantees that water temperature remains in the desired range

SCAN FOR
INSTALLATION
INSTRUCTIONS



VENETIAN
DECK-MOUNTED

Year Warranty
3

Fully Guaranteed
Against Defects in
Parts and Workmanship

All models come supplied with an auto open line purge feature that eliminates stagnant water and bacterial growth.



UTILITY REFUSE
AND RECYCLING

DECORATIVE REFUSE

CLEANING

MATERIAL HANDLING

WASHROOM

FOODSERVICE

ACCESSORIES
& INDEX

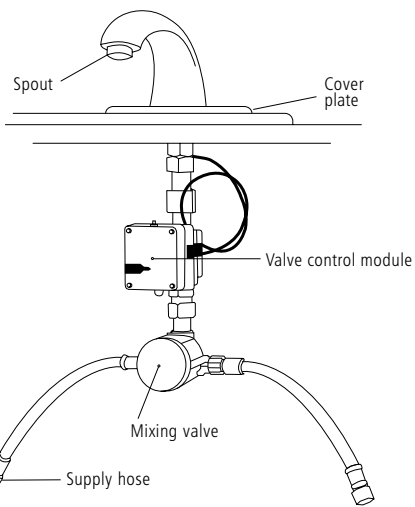

Certified by IAPMO R&T for compliance with Lead Plumbing Law





MILANO



VERONA



VENETIAN

	Finish	Single Hole Mount	4" Center Set	8" Center Set	Flow Rate (GPM)	Valve Control Module	Main Supply Hose	Mixing Valve	Thermostatic Mixing Valve	Hot/Cold Supply Hoses
MILANO 	Polished Chrome	1903286	1903288	1903291	1.5 aerated	●				
	Polished Chrome	1903287	1903289	1903290	1.5 aerated	●	●			
	Polished Chrome	1782742	1782743	1782744	1.5 aerated	●		●		●
	Polished Chrome	1818966	1818967	1818968	1.5 aerated	●			●	●
VERONA 	Polished Chrome	1903281			1.5 aerated	●			●	●
VENETIAN 	Polished Chrome 5.5"	FG750353	FG750354	FG750355	2.2 laminar	●			●	●

AutoFaucet® Single Hole Mounts

NO.	DESCRIPTION	U.S. DIMENSIONS	U.S. SHIP WT/CASE	U.S. CASE CUBE	METRIC DIMENSIONS	METRIC SHIP WT/CASE	METRIC CASE CUBE	KIT	CASE PACK
1903286	Milano in Polished Chrome	6.50" l x 2.13" w x 3.75" h	6.0 lb	0.26 ft³	16.5 cm x 5.4 cm x 9.5 cm	2.72 kg	0.01 m³	1	1
1903287	Milano in Polished Chrome	6.50" l x 2.13" w x 3.75" h	6.0 lb	0.26 ft³	16.5 cm x 5.4 cm x 9.5 cm	2.72 kg	0.01 m³	2	1
1818966	Milano in Polished Chrome	6.50" l x 2.13" w x 3.75" h	6.0 lb	0.26 ft³	16.5 cm x 5.4 cm x 9.5 cm	2.72 kg	0.01 m³	4	1
1782742	Milano in Polished Chrome	6.50" l x 2.13" w x 3.75" h	7.0 lb	0.26 ft³	16.5 cm x 5.4 cm x 9.5 cm	3.18 kg	0.01 m³	6	1
1903281	Verona in Polished Chrome	6.75" l x 2.50" w x 5.00" h	6.0 lb	0.26 ft³	17.15 cm x 6.35 cm x 8.89 cm	2.72 kg	0.01 m³	4	1
FG750353	Venetian 5.5" in Polished Chrome	7.63" l x 2.00" w x 10.00" h	7.0 lb	0.26 ft³	19.38 cm x 5.08 cm x 25.4 cm	3.18 kg	0.01 m³	4	1

*Supplied with 1.5 GPM (5.7 L/min.) laminar flow; can be ordered with Flow Control Aerator that delivers 0.5 GPM, 1.0 GPM, 1.5 GPM, 2.0 GPM, or 2.2 GPM.

AutoFaucet® 4" Center Sets

NO.	DESCRIPTION	U.S. DIMENSIONS	U.S. SHIP WT/CASE	U.S. CASE CUBE	METRIC DIMENSIONS	METRIC SHIP WT/CASE	METRIC CASE CUBE	KIT	CASE PACK
1903288	Milano in Polished Chrome	6.50" l x 2.13" w x 3.75" h	7.0 lb	0.26 ft³	16.5 cm x 5.4 cm x 9.5 cm	3.18 kg	0.01 m³	1	1
1903289	Milano in Polished Chrome	6.50" l x 2.13" w x 3.75" h	7.0 lb	0.26 ft³	16.5 cm x 5.4 cm x 9.5 cm	3.18 kg	0.01 m³	2	1
1782743	Milano in Polished Chrome (Low Lead)	6.50" l x 2.13" w x 3.75" h	7.0 lb	0.26 ft³	16.5 cm x 5.4 cm x 9.5 cm	3.18 kg	0.01 m³	3	1
1818967	Milano in Polished Chrome	6.50" l x 2.13" w x 3.75" h	7.0 lb	0.26 ft³	16.5 cm x 5.4 cm x 9.5 cm	3.18 kg	0.01 m³	4	1
FG750354	Venetian 5.5" in Polished Chrome	7.63" l x 2.00" w x 10.00" h	7.0 lb	0.26 ft³	19.38 cm x 5.08 cm x 25.4 cm	3.18 kg	0.01 m³	4	1

AutoFaucet® 8" Center Sets

NO.	DESCRIPTION	U.S. DIMENSIONS	U.S. SHIP WT/CASE	U.S. CASE CUBE	METRIC DIMENSIONS	METRIC SHIP WT/CASE	METRIC CASE CUBE	KIT	CASE PACK
1903291	Milano in Polished Chrome	6.50" l x 2.13" w x 3.75" h	7.0 lb	0.26 ft³	16.5 cm x 5.4 cm x 9.5 cm	3.18 kg	0.01 m³	1	1
1903290	Milano in Polished Chrome	6.50" l x 2.13" w x 3.75" h	7.0 lb	0.26 ft³	16.5 cm x 5.4 cm x 9.5 cm	3.18 kg	0.01 m³	2	1
1782744	Milano in Polished Chrome (Low Lead)	6.50" l x 2.13" w x 3.75" h	7.0 lb	0.26 ft³	16.5 cm x 5.4 cm x 9.5 cm	3.18 kg	0.01 m³	3	1
1818968	Milano in Polished Chrome	6.50" l x 2.13" w x 3.75" h	7.0 lb	0.26 ft³	16.5 cm x 5.4 cm x 9.5 cm	3.18 kg	0.01 m³	4	1
FG750355	Venetian 5.5" Polished Chrome	7.63" l x 2.00" w x 10.00" h	7.0 lb	0.26 ft³	19.38 cm x 5.08 cm x 25.4 cm	3.18 kg	0.01 m³	4	1

Kit 1 Includes: spout and valve control module

Kit 2 Includes: spout, valve control module, and main supply hose (1/2" pipe x 3/8" comp. x 12" length)

Kit 3 Includes: spout, valve control module, mixing valve, and hot/cold supply hoses (3/8" comp. x 3/8" comp. x 12" length)

Kit 4 Includes: spout, valve control module, thermostatic mixing valve, and hot/cold supply hoses (3/8" comp. x 3/8" comp. x 12" length)

Kit 5 Includes: spout, valve control module, mixing valve, and hot/cold supply hoses (3/8" comp. x 1/2" comp. x 12" length)

Kit 6 Includes: 0.5 GPM spout, valve control module, mixing valve, and hot/cold supply hoses (3/8" comp. x 3/8" comp. x 12" length)



UTILITY REFUSE
AND RECYCLING

DECORATIVE REFUSE

CLEANING

MATERIAL HANDLING

WASHROOM

FOODSERVICE

ACCESSORIES
& INDEX

Auto Flush®

Touch-free, cost-effective flushing systems for high traffic washrooms.

- Smart Object Infrared Technology manages flushing automation for world-class reliability
- Promotes good hygiene by eliminating potential points of cross-contamination
- Prevents odors by ensuring that fixtures are flushed after every use
- No water shutoff is required during installation
- Auto Flush® Systems are available for toilets and urinals
- Installs in minutes



Simply slides over existing handle



Auto Flush® Sidemount

Sidemount style allows for easy installation by replacing current flush handle.

- Easy installation automates flush handles in minutes
- Eliminates source of odor
- Battery reserve feature allows 9,000 flushes after low battery indicator begins flashing
- Angled lens design combined with advanced sensor technology guarantees activation even with the toilet seat raised
- Toilet and urinal models available; toilet model has courtesy flush button
- Long battery life, 3+ years or up to 100,000 flushes (4 "C" batteries included)



FG401186A



FG401187A

Auto Flush® Clamp

Clamp style allows for easy installation directly over current flush handle.

- Easy installation automates flush handles in minutes.
- Eliminates source of odor
- Battery reserve feature allows 9,000 flushes after low battery indicator begins flashing
- Angled lens design combined with advanced sensor technology guarantees activation even with the toilet seat raised
- Toilet and urinal models available; toilet model has courtesy flush button
- Long battery life, 3+ years or up to 60,000 flushes (4 "C" batteries included)



FG401804A
Urinal



FG401805A
Toilet

SCAN FOR
INSTALLATION
VIDEOS



SCAN FOR
INSTALLATION
VIDEOS



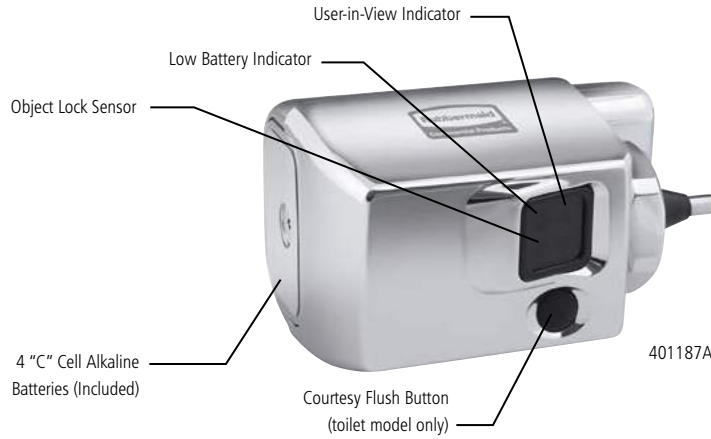

Auto Flush® Urinals

NO.	DESCRIPTION	U.S. DIMENSIONS	U.S. SHIP WT/CASE	U.S. CASE CUBE	METRIC DIMENSIONS	METRIC SHIP WT/CASE	METRIC CASE CUBE	CASE PACK
FG401804A	Auto Flush® Clamp Polished Chrome Urinal	5.313" l x 3.56" w x 3.63" h	1.5 lb	0.14 ft³	13.5 cm x 9.04 cm x 9.22 cm	0.68 kg	0.004 m³	1
FG402060A	Auto Flush® Clamp Polished Chrome Urinal - Metal	5.313" l x 3.56" w x 3.63" h	1.5 lb	0.14 ft³	13.5 cm x 9.04 cm x 9.22 cm	0.68 kg	0.004 m³	1

Auto Flush® Urinals (for Sloan or Zurn flush valves)

NO.	DESCRIPTION	U.S. DIMENSIONS	U.S. SHIP WT/CASE	U.S. CASE CUBE	METRIC DIMENSIONS	METRIC SHIP WT/CASE	METRIC CASE CUBE	CASE PACK
FG401186A	Auto Flush® Sidemount Polished Chrome Urinal	4.75" l x 3.30" w x 2.80" h	2.3 lb	0.15 ft³	12 cm x 8.38 cm x 7.11 cm	1.04 kg	0.004 m³	1
FG401982	Auto Flush® Sidemount Polished Chrome Urinal — Metal	4.75" l x 3.30" w x 2.80" h	2.3 lb	0.15 ft³	12 cm x 8.38 cm x 7.11 cm	1.04 kg	0.004 m³	1

Auto Flush® Urinal (for Coyne & Delany Flushboy valves)

NO.	DESCRIPTION	U.S. DIMENSIONS	U.S. SHIP WT/CASE	U.S. CASE CUBE	METRIC DIMENSIONS	METRIC SHIP WT/CASE	METRIC CASE CUBE	CASE PACK
FG401207A	Auto Flush® Sidemount Polished Chrome Urinal	4.75" l x 3.30" w x 2.80" h	2.3 lb	0.15 ft³	12 cm x 8.38 cm x 7.11 cm	1.04 kg	0.004 m³	1

Auto Flush® Toilets

NO.	DESCRIPTION	U.S. DIMENSIONS	U.S. SHIP WT/CASE	U.S. CASE CUBE	METRIC DIMENSIONS	METRIC SHIP WT/CASE	METRIC CASE CUBE	CASE PACK
FG401805A	Auto Flush® Clamp Polished Chrome Toilet	5.313" l x 3.56" w x 3.63" h	1.5 lb	0.14 ft³	13.5 cm x 9.04 cm x 9.22 cm	0.68 kg	0.004 m³	1
FG402059A	Auto Flush® Clamp Polished Chrome Toilet — Metal	5.313" l x 3.56" w x 3.63" h	1.5 lb	0.14 ft³	13.5 cm x 9.04 cm x 9.22 cm	0.68 kg	0.004 m³	1

Auto Flush® Toilets (for Sloan or Zurn flush valves)

NO.	DESCRIPTION	U.S. DIMENSIONS	U.S. SHIP WT/CASE	U.S. CASE CUBE	METRIC DIMENSIONS	METRIC SHIP WT/CASE	METRIC CASE CUBE	CASE PACK
FG401187A	Auto Flush® Sidemount Polished Chrome Toilet	4.75" l x 3.30" w x 2.80" h	2.3 lb	0.15 ft³	12 cm x 8.38 cm x 7.11 cm	1.04 kg	0.004 m³	1
FG401981	Auto Flush® Sidemount Polished Chrome Toilet — Metal	4.75" l x 3.30" w x 2.80" h	2.3 lb	0.15 ft³	12 cm x 8.38 cm x 7.11 cm	1.04 kg	0.004 m³	1

Auto Flush® Toilet (for Coyne & Delany Flushboy valves)

NO.	DESCRIPTION	U.S. DIMENSIONS	U.S. SHIP WT/CASE	U.S. CASE CUBE	METRIC DIMENSIONS	METRIC SHIP WT/CASE	METRIC CASE CUBE	CASE PACK
FG401206A	Auto Flush® Sidemount Polished Chrome Toilet	4.75" l x 3.30" w x 2.80" h	2.3 lb	0.15 ft³	12 cm x 8.38 cm x 7.11 cm	1.04 kg	0.004 m³	1

Sidemount Adapters

NO.	DESCRIPTION	U.S. DIMENSIONS	U.S. SHIP WT/CASE	U.S. CASE CUBE	METRIC DIMENSIONS	METRIC SHIP WT/CASE	METRIC CASE CUBE	CASE PACK
401096	Auto Flush® High Mount Adapter Kit	4.75" l x 3.30" w x 2.80" h	2.3 lb	0.15 ft³	12 cm x 8.38 cm x 7.11 cm	1.04 kg	0.004 m³	1
401165	Auto Flush® Crane Valve Adapter Kit	4.75" l x 3.30" w x 2.80" h	2.3 lb	0.15 ft³	12 cm x 8.38 cm x 7.11 cm	1.04 kg	0.004 m³	1
401239	Auto Flush® Teck Valve Adapter	4.75" l x 3.30" w x 2.80" h	2.3 lb	0.15 ft³	12 cm x 8.38 cm x 7.11 cm	1.04 kg	0.004 m³	1
401477	Auto Flush® Tempus Valve Adapter	4.75" l x 3.30" w x 2.80" h	2.3 lb	0.15 ft³	12 cm x 8.38 cm x 7.11 cm	1.04 kg	0.004 m³	1

Clamp Adapters

NO.	DESCRIPTION	U.S. DIMENSIONS	U.S. SHIP WT/CASE	U.S. CASE CUBE	METRIC DIMENSIONS	METRIC SHIP WT/CASE	METRIC CASE CUBE	CASE PACK
401972	Auto Flush® Coyne & Delany/Crane Rex Adapter Kit	5.313" l x 3.56" w x 3.63" h	1.5 lb	0.14 ft³	13.5 cm x 9.04 cm x 9.22 cm	0.68 kg	0.004 m³	1
401973	Auto Flush® Canadian Adapter Kit (Crane, Teck, Tempus)	5.313" l x 3.56" w x 3.63" h	1.5 lb	0.14 ft³	13.5 cm x 9.04 cm x 9.22 cm	0.68 kg	0.004 m³	1
4870577	Auto Flush® Power Adapter Kit	5.313" l x 3.56" w x 3.63" h	1.5 lb	0.14 ft³	13.5 cm x 9.04 cm x 9.22 cm	0.68 kg	0.004 m³	1



AutoClean®

AutoClean® Systems deliver powerful formulas that attack and eliminate odors at the source—automatically cleaning fixture surfaces, day and night.

- Easy in-line installation allows cleaning solution to reach the hard to clean areas, such as rim holes, ensuring that the whole fixture is cleaned
- Refills deliver consistent metered dosage of Purinel® SC to prevent buildup of calcium on pipes and scaling
- Flexible programming options: up to 90-day refill cycle settings
- Industry-leading battery life of up to 3 years

SCAN FOR
INSTALLATION
VIDEOS



FG400586 / FG401591 / FG401532



ADA COMPLIANT

AutoClean® Dispensers

NO.	DESCRIPTION	U.S. DIMENSIONS	U.S. SHIP WT/CASE	U.S. CASE CUBE	METRIC DIMENSIONS	METRIC SHIP WT/CASE	METRIC CASE CUBE	CASE PACK
FG500409	AutoClean® LED Dispenser — Chrome (Kit w/ 3/4" Connector)	12.50" l x 1.25" w x 6.75" h	4.0 lb	0.23 ft³	31.8 cm x 3.2 cm x 17.1 cm	1.8 kg	0.01 m³	1
FG500410	AutoClean® LED Dispenser — Chrome (Kit w/ 1/2" Connector)	12.50" l x 1.25" w x 6.75" h	4.0 lb	0.24 ft³	31.8 cm x 3.2 cm x 17.1 cm	1.8 kg	0.01 m³	1

*Kits contain: AutoClean® Dispenser, Mounting Hardware, Batteries, Connection Kit, and Stainless Steel Connection Tube.

AutoClean® Refills

NO.	DESCRIPTION	U.S. DIMENSIONS	U.S. SHIP WT/CASE	U.S. CASE CUBE	METRIC DIMENSIONS	METRIC SHIP WT/CASE	METRIC CASE CUBE	CASE PACK
FG400586	Purinel® SC — Drain Maintainer & Cleaner	1.8" l x 3.9" w x 5.9" h	1.0 lb	0.19 ft³	4.5 cm x 9.9 cm x 14.9 cm	0.5 kg	0.01 m³	6
FG401591	AutoClean® Cleaner & Deodorizer Refill — Linen Fresh™	1.8" l x 3.9" w x 5.9" h	1.0 lb	0.21 ft³	4.5 cm x 9.9 cm x 14.9 cm	0.5 kg	0.01 m³	6
FG401532	AutoClean® Cleaner & Deodorizer Refill — Mandarin Orange	1.8" l x 3.9" w x 5.9" h	1.0 lb	0.19 ft³	4.5 cm x 9.9 cm x 14.9 cm	0.5 kg	0.01 m³	6

Auto Janitor®

Auto Janitor® cleans and deodorizes toilets and urinals while providing a clean fresh scent for the restroom.

- Programmable dispenser operates round-the-clock automatically cleaning fixture surfaces, day and night, at 15-, 30-, or 60-day refill cycles
- Concentrated foaming action cleans and reduces bacteria growth everywhere the water goes
- Auto Janitor® BioFlush® formula is enzyme-based to help prevent scale buildup in drain pipes



FG400980



Auto Janitor® Dispenser & Accessories

NO.	DESCRIPTION	U.S. DIMENSIONS	U.S. SHIP WT/CASE	U.S. CASE CUBE	METRIC DIMENSIONS	METRIC SHIP WT/CASE	METRIC CASE CUBE	CASE PACK
1793506	Auto Janitor® LED Dispenser — White	1.92" l x 1.67" w x 2" h	2.00 lb	0.95 ft³	4.9 cm x 4.2 cm x 5.1 cm	0.90 kg	0.03 m³	6
1793507	Auto Janitor® LED Dispenser — Chrome	1.92" l x 1.67" w x 2" h	2.00 lb	0.95 ft³	4.9 cm x 4.2 cm x 5.1 cm	0.90 kg	0.03 m³	6
4012902T	2nd Fixture Kit	-	0.42 lb	0.64 ft³	-	0.19 kg	0.02 m³	12

Auto Janitor® Refills

NO.	DESCRIPTION	U.S. SHIP WT/CASE	U.S. CASE CUBE	METRIC SHIP WT/CASE	METRIC CASE CUBE	CASE PACK
FG400978	Auto Janitor® Cleaner & Deodorizer Refill — Linen Fresh™	11 lbs	0.42 ft³	5.0 kg	0.01 m³	6
FG400980	Auto Janitor® Cleaner & Deodorizer Refill — Mandarin Orange	11 lbs	0.33 ft³	5.0 kg	0.01 m³	6
FG400982	Auto Janitor® Cleaner & Deodorizer Refill — Country Delight™	11 lbs	0.33 ft³	5.0 kg	0.01 m³	6
FG400055	Auto Janitor® BioFlush® Drain Maintenance Refill	11 lbs	0.36 ft³	5.0 kg	0.01 m³	6

Clean Seat

Clean Seat foam and spray toilet seat, baby changing station, and handle cleaners provide an added level of personal hygiene to washroom users.

- Antimicrobial push bar with silver-ion technology reduces cross-contamination
- Foam refill dispenses 1000 shots of 0.4 mL per dose; spray refill dispenses 2000 shots of 0.2 mL per dose
- Alcohol-based solution removes dirt and bacteria and eliminates the need for messy and awkward seat covers



ADA COMPLIANT



Just spray the solution on a toilet tissue, and then wipe the surfaces clean. Handle and seat are hygienic and ready for use in seconds.



FG402310



FG450008

Clean Seat Dispensers

NO.	DESCRIPTION	U.S. DIMENSIONS	U.S. SHIP WT/CASE	U.S. CASE CUBE	METRIC DIMENSIONS	METRIC SHIP WT/CASE	METRIC CASE CUBE	CASE PACK
FG402310	Clean Seat Foam 400 mL Dispenser — White	5.50" l x 4.75" w x 8.00" h	12.0 lb	1.8 ft ³	14 cm x 12.1 cm x 20.3 cm	5.4 kg	0.05 m ³	12
FG450008	Clean Seat Soap Spray 400 mL Dispenser — White	4.30" l x 3.70" w x 8.25" h	11.4 lb	1.9 ft ³	10.9 cm x 9.4 cm x 21 cm	5.2 kg	0.05 m ³	12



FG402312



FG402537

Clean Seat Refills

NO.	DESCRIPTION	U.S. SIZE	U.S. SHIP WT/CASE	U.S. CASE CUBE	METRIC SHIP WT/CASE	METRIC CASE CUBE	CASE PACK
FG402312	Clean Seat Foaming Refill	400 mL	11.9 lb	0.47 ft ³	5.4 kg	0.01 m ³	12
FG402537	Clean Seat Spray Refill	400 mL	1.0 lb	0.41 ft ³	0.5 kg	0.01 m ³	12

UTILITY REFUSE AND RECYCLING

DECORATIVE REFUSE

CLEANING

MATERIAL HANDLING

WASHROOM

FOODSERVICE

ACCESSORIES & INDEX



Baby Changing Stations

Horizontal and vertical baby changing stations meet all applicable ASTM, ADA, FDA, and EN global safety regulations and standards.

- Antimicrobial protection
- Easy-reach hooks
- Built-in shelf and liner storage



FG781888



FG781988

NO.	COLOR	DESCRIPTION	U.S. DIMENSIONS	U.S. SHIP WT/CTN	METRIC DIMENSIONS	METRIC SHIP WT/CTN	PACK
FG781788	WHT	Protective Liners for Baby Changing Stations Laminated 2-ply Tissue Paper	13.25" l x 5.50" w x 0.00" h	4.8 lb	33.7 cm x 14 cm x 0 cm	2.2 kg	1/320 Ctn
FG781888	LPLAT	Baby Changing Station Horizontal	33.25" l x 21.50" w x 4.00" h	23.5 lb	84.5 cm x 54.6 cm x 10.2 cm	10.7 kg	1
FG781988	LPLAT	Baby Changing Station Vertical	23.00" l x 34.10" w x 4.00" h	25.0 lb	58.4 cm x 86.6 cm x 10.2 cm	11.3 kg	1

When ordering products with **BOLD** color codes, please specify color code after the product number. Refer to the Standard Color Guide at the back of the catalog.

UTILITY REFUSE AND RECYCLING

DECORATIVE REFUSE

CLEANING

MATERIAL HANDLING

WASHROOM

FOODSERVICE

ACCESSORIES & INDEX

Sanitary Bins

Designed to provide a safe and hygienic way to dispose of sanitary waste.

- Deep chute prevents waste adhesion and promotes better hygiene
- Dry system bins are lined so the interior is never soiled
- Pedal operation limits direct contact
- Smooth contoured shape does not harbor dirt or germs and is easy to clean



FG402348



SaniSense Bin Deodorizer™ activates when waste is placed in the bin.

NO.	DESCRIPTION	U.S. DIMENSIONS	U.S. SHIP WT/CASE	U.S. CASE CUBE	METRIC DIMENSIONS	METRIC SHIP WT/CASE	METRIC CASE CUBE	CASE PACK
FG402338	Sanitary Bin 5 Gallon — White	22.8" l x 6.1" w x 19.3" h	26.4 lb	7.6 ft³	57.9 cm x 15.5 cm x 49 cm	12.0 kg	0.22 m³	4
FG750243	Sanitary Bin 3 Gallon — White	16.5" l x 6.1" w x 19.3" h	5.1 lb	1.3 ft³	41.9 cm x 15.5 cm x 49 cm	2.3 kg	0.04 m³	1
FG750244	Sanitary Bin 3 Gallon — Gray	16.5" l x 6.1" w x 19.3" h	5.1 lb	1.3 ft³	41.9 cm x 15.5 cm x 49 cm	2.3 kg	0.04 m³	1
FG402348	SaniSense Bin Deodorizer™	N/A	29.0 lb	0.9 ft³	N/A	13.2 kg	0.03 m³	12
FG402339	Sanitary Bin 5 Gallon Liners — 15 per roll	N/A	6.8 lb	0.3 ft³	N/A	3.1 kg	0.01 m³	1
FG750443	Sanitary Bin 3 Gallon Liners — 15 per roll	N/A	6.8 lb	0.3 ft³	N/A	3.1 kg	0.01 m³	25

Sanitary Napkin Receptacles

Space-saving and easy to service.

- Tight-fitting lids help contain odors
- Removable rigid liner is easy to clean and maintain
- Durable plastic and metal receptacles



FG614000



FG614100

NO.	COLOR	DESCRIPTION	U.S. DIMENSIONS	U.S. SHIP WT/CTN	METRIC DIMENSIONS	METRIC SHIP WT/CTN	MATERIAL TYPE	PACK
FG614000	WHT	Sanitary Napkin Receptacle with Rigid Liner	10.75" l x 5.25" w x 12.5" h	2.6 lb	27.3 cm x 13.3 cm x 31.8 cm	1.2 kg	Plastic	1
FG614100	0000	Waxed Bags for Sanitary Napkin Receptacle	8.75" l x 8.50" h	6.2 lb	22.2 cm x 21.6 cm	2.8 kg		1/250

Safty-Grip® Bath and Shower Mats

Perfect for shower stall or bathtub.

- Suction-backed to stay firmly in place
- Latex-free construction
- Textured surface prevents slippage
- Shower mat is perforated for improved drainage
- Mildew-resistant



1982725



1982724

NO.	COLOR	DESCRIPTION	U.S. DIMENSIONS	U.S. SHIP WT/CTN	METRIC DIMENSIONS	METRIC SHIP WT/CTN	PACK
1982721	Brown Stone	Safty-Grip® Bath Mat, Medium	22.50" l x 14.00" w	4.9 lb	57.2 cm x 35.6 cm	2.2 kg	12
1982724	White	Safty-Grip® Bath Mat, Medium	22.50" l x 14.00" w	4.9 lb	57.2 cm x 35.6 cm	2.2 kg	12
1982725	Brown Stone	Safty-Grip® Bath Mat, Large	28.00" l x 16.00" w	8.9 lb	71.1 cm x 40.6 cm	4.0 kg	12
1982726	White	Safty-Grip® Bath Mat, Large	28.00" l x 16.00" w	8.9 lb	71.1 cm x 40.6 cm	4.0 kg	12
1982728	Brown Stone	Safty-Grip® Bath Mat, XLarge	36.00" l x 18.00" w	12.4 lb	91.4 cm x 45.7 cm	5.6 kg	12
1982729	White	Safty-Grip® Bath Mat, XLarge	36.00" l x 18.00" w	12.4 lb	91.4 cm x 45.7 cm	5.6 kg	12
1982727	White	Safty-Grip® Shower Mat	22.25" l x 22.25" w	1.3 lb	56.5 cm x 56.5 cm	0.6 kg	12

UTILITY REFUSE AND RECYCLING

DECORATIVE REFUSE

CLEANING

MATERIAL HANDLING

WASHROOM

FOODSERVICE

ACCESSORIES & INDEX



UTILITY REFUSE
AND RECYCLING



FOODSERVICE

DECORATIVE REFUSE

CLEANING

MATERIAL HANDLING

WASHROOM

FOODSERVICE

ACCESSORIES
& INDEX



PROSERVE® INGREDIENT BINS



1980418

STORAGE

ProSave® Ingredient Management System – Bins 222
 Racks for Shelf Ingredient Bins..... 223
 ProSave® Ingredient Management System – BRUTE® and Sliding Lids 224
 Food Boxes 226
 Freshworks™ Produce Saver..... 227
 Space-Saving Square Containers..... 228
 Square Container Lids..... 228
 Round Storage Containers 229
 Round Container Lids 229
 Heavy-Duty Hot and Cold Food Pans 230

PREPARATION

High-Heat Scrapers and Spoons..... 232
 Cold Scrapers and Spoons 232
 Measuring Cups and Spoons 232
 Bouncer® Measuring Cups 233
 Bouncer® Scoops and Bouncer® Portioning Scoops..... 233
 BRUTE® GreensKeeper® Containers 233

MONITORING

Premium Digital Portion Control Scales 234
 Digital Portion Control Scales..... 234
 Premium Mechanical Portion Control Scales..... 235
 Stainless Steel Scales, Dishwasher-Safe..... 235
 Mechanical Portion Control Scales 235
 Digital Receiving Utility Scales 236
 Briefcase/Utility Mechanical Receiving Scales 236
 Fixed Dial Platform Receiving Scales 236

TRANSPORT

ProServe® Ice Handling System..... 237
 BRUTE® "ICE ONLY" Container 237
 ProServe® Lightweight Insulated Carriers..... 238
 ProServe® Professional Delivery Bags..... 239
 ProServe® Sheet Pan Rack System..... 239
 ProServe® Racks and Carts..... 240

TABLE SERVICE

Bus/Tote Boxes..... 241
 Cutlery Bin..... 241
 Bouncer® Pitchers 241

YOUTH SERVICE

Sturdy Chair™ Youth Seats 242

FOODSERVICE

KEEP PRODUCE FRESHER LONGER*

The FreshWorks™ Produce Saver regulates the flow of oxygen and ethylene, creating the optimal environment to store fruits and vegetables. By allowing the produce to “breathe”, the FreshWorks™ Produce Saver helps maintain stay at their peak freshness for a longer period of time, reducing the amount of food thrown away due to spoilage.

*Based on produce stored in RCP FreshWorks™ Produce Saver vs traditional food box.



FILTER

The integrated filter naturally regulates the flow of oxygen to allow produce to remain fresh for an extended period of time.



DRAIN TRAY

The built in drain tray promotes air flow while elevating produce from any residual moisture, preventing a soggy product.



AIR TIGHT LID

The air tight lid is easy to open and close helping to create the perfect environment within the container.

ProSave® Ingredient Management System
INGREDIENT BINS

Improved productivity through integrated lid and scoop system.

- Integrated lid and measuring scoop allows for quick one-handed access to stored ingredients
- Clear window for fast ingredient identification and inventory management
- Certified to NSF/ANSI/3-A and 2 Standards
- Commercial dishwasher-safe
- Complies with FDA Food code 3-304.12 to increase inspection score
- One-handed access while stacked improves space efficiency
- FIFO (First In First Out) barrier for proper food rotation improves food quality



65%

PRODUCTIVITY SAVINGS

with one-handed access



FG360088
400 Cups
124 lb flour



FG360288
500 Cups
154 lb flour



FG360388
600 Cups
188 lb flour



FG9G6000
40 Cups
13 lb flour



FG9G5700
100 Cups
25 lb flour



FG9G5800
200 Cups
50 lb flour



Dedicated internal scoop, included with bin, has proper storage to meet safety compliance.



Speed up food preparation with one-handed access.



Ensure proper food rotation with FIFO barrier.

ProSave® Ingredient Bins

NO.	COLOR	DESCRIPTION	U.S. CAPACITY (GAL/CU. FT)	U.S. FLOUR/SUGAR CAPACITY	DIMENSIONS	U.S. SHIP WT/CTN	METRIC CAPACITY	METRIC FLOUR/SUGAR CAPACITY	METRIC DIMENSIONS	METRIC SHIP WT/CTN	PACK
FG9G6000	WHT	40-Cup Shelf Ingredient Bin with 1/2-Cup Scoop	2.63 gal .33 cu ft	Flour: 13 lb Sugar: 17 lb	15" l x 11.75" w x 8.5" h	3.30 lb	.12 m ³	Flour: 5.90 kg Sugar: 7.71 kg	38.1 cm x 29.8 cm x 21.6 cm	1.5 kg	1
FG9G5700	WHT	100-Cup Shelf Ingredient Bin with 2-Cup Scoop	6.25 gal .836 cu ft	Flour: 25 lb Sugar: 50 lb	23.5" l x 11.5" w x 16.88" h	13.25 lb	.08 m ³	Flour: 11.34 kg Sugar: 22.68 kg	59.7 cm x 29.2 cm x 42.9 cm	6.01 kg	1
FG9G5800	WHT	200-Cup Shelf Ingredient Bin with 2-Cup Scoop	12.63 gal 1.67 cu ft	Flour: 50 lb Sugar: 100 lb	23.5" l x 19.2" w x 16.88" h	18.5 lb	.10 m ³	Flour: 22.68 kg Sugar: 45.36 kg	59.7 cm x 48.8 cm x 42.9 cm	8.39 kg	1
FG360088	WHT	Slant-Front Ingredient Bin with Sliding Lid and 32-oz (0.9-L) Scoop	20.5 gal 2.75 cu ft	Flour: 124 lb Sugar: 158 lb	29.25" l x 13.13" w x 28" h	27.7 lb	.08 m ³	Flour: 56.3 kg Sugar: 72.7 kg	74.3 cm x 33.4 cm x 71.1 cm	12.6 kg	1
FG360288	WHT	Slant-Front Ingredient Bin with Sliding Lid and 32-oz (0.9-L) Scoop	26.2 gal 3.5 cu ft	Flour: 154 lb Sugar: 197 lb	29.5" l x 15.5" w x 28" h	32.7 lb	.1 m ³	Flour: 69.9 kg Sugar: 89.4 kg	74.9 cm x 39.4 cm x 71.1 cm	14.8 kg	1
FG360388	WHT	Slant-Front Ingredient Bin with Sliding Lid and 32-oz (0.9-L) Scoop	30.8 gal 4.12 cu ft	Flour: 188 lb Sugar: 240 lb	29.75" l x 18" w x 28" h	38.7 lb	.12 m ³	Flour: 85.3 kg Sugar: 108.9 kg	75.6 cm x 45.7 cm x 71.1 cm	17.6 kg	1

ProSave® Lids With Scoops

NO.	COLOR	DESCRIPTION	U.S. DIMENSIONS	FITS RUBBERMAID® INGREDIENT BIN	U.S. SHIP WT/CTN	METRIC DIMENSIONS	METRIC SHIP WT/CTN	PACK
FG9F7700	CLR	Sliding Lid with 32-oz (0.9-L) Scoop for FG360088 Ingredient Bin	29" l x 12.1" w x 1.9" h	FG360088	5.8 lb	73.7 cm x 30.7 cm x 4.8 cm	2.6 kg	1
FG9F7800	CLR	Sliding Lid with 32-oz (0.9-L) Scoop for FG360288 Ingredient Bin	29" l x 14.5" w x 1.9" h	FG360288	6.5 lb	73.7 cm x 36.8 cm x 4.8 cm	2.9 kg	1
FG9F7900	CLR	Sliding Lid with 32-oz (0.9-L) Scoop for FG360388 Ingredient Bin	29" l x 17.2" w x 1.9" h	FG360388	7.4 lb	73.7 cm x 43.7 cm x 4.8 cm	3.4 kg	1

UTILITY REFUSE AND RECYCLING

DECORATIVE REFUSE

CLEANING & SAFETY

MATERIAL HANDLING

WASHROOM

FOODSERVICE

ACCESSORIES & INDEX

Racks for Shelf Ingredient Bins

Store and transport bins efficiently throughout the operation.

- Maximize space for kitchen preparation and storeroom for ingredient storage
- Racks designed to hold and transport 200 lbs. (90.7 kg) per shelf
- 5" nonmarking casters for safe transport
- Locating bar on shelf to secure bins during transport
- Customize your shelf ingredient bins in storage with different configurations



FG9G5900
Rack
26" Wide



FG9G7900
Rack
38" Wide



FG9G8000
Rack
50" Wide

Racks For ProSave® Shelf Ingredient Bins

NO.	COLOR	DESCRIPTION		U.S. DEPTH	U.S. WIDTH	U.S. HEIGHT	CASE WEIGHT (LBS)	METRIC DEPTH	METRIC WIDTH	METRIC HEIGHT	CASE WEIGHT (KG)	CASE PACK
FG9G5900	CHRM	Cart for Shelf Ingredient Bins	2 Shelves, Each Shelf Holds (4) FG9G6000, (2) FG9G5700, or (1) FG9G5800	18"	26"	47.75"	37.5 lb	45.7 cm	66 cm	121.3 cm	17 kg	1
FG9G7900	CHRM	Mobile Rack for Shelf Ingredient Bins, 38" wide	3 Shelves, Each Shelf Holds (6) FG9G6000, (3) FG9G5700, or (1) FG9G5800	18"	38"	48.276"	43.8 lb	35.6 cm	96.5 cm	122.6 cm	19.9 kg	1
FG9G8000	CHRM	Mobile Rack for Shelf Ingredient Bins, 50" wide	4 Shelves, Each Shelf Holds (8) FG9G6000, (4) FG9G5700, or (2) FG9G5800	18"	50"	67.157"	76.0 lb	45.7 cm	127 cm	170.5 cm	34.5 kg	1

Scoops

NO.	COLOR	DESCRIPTION	CUPS (LITERS)	U.S. DEPTH	U.S. WIDTH	U.S. HEIGHT	CASE WEIGHT (LBS)	METRIC DEPTH	METRIC WIDTH	METRIC HEIGHT	CASE WEIGHT (KG)	CASE PACK
FG9G8200*	WHT	1/2-Cup Measuring Scoop for FG9G6000 Shelf Ingredient Bin	1/2 Cup (0.12 L)	7.38"	3.38"	1.50"	1.05 lb	18.7 cm	8.6 cm	3.8 cm	.48 kg	12
FG9F7500*	CLR	Bouncer® Contour Scoop for FG360088, FG360288, FG360388 Ingredient Bins and FG9G7700	32 oz (0.95 L)	10.8"	4.8"	4.7"	4.2 lb	27.4 cm	12.2 cm	12 cm	1.9 kg	6
FG9F7600*	CLR	Bouncer® Contour Scoop for FG360088, FG360288, FG360388 Ingredient Bins and FG9G7800	64 oz (1.90 L)	13.44"	5.89"	6.0"	6.2 lb	34.1 cm	15 cm	15.2 cm	2.8 kg	6
FG9G5100*	CLR	Bouncer® Portioning Scoop for FG9G5700, FG9G5800 Shelf Ingredient Bins and FG9G7600, FG9G7300	2 Cups (0.47 L)	4.6"	5.1"	5.25"	3.2 lb	11.7 cm	13 cm	13.3 cm	1.4 kg	12
FG9G5200*	CLR	Bouncer® Portioning Scoop for FG9G7700, FG9G7400 Sliding Lid	3 Cups (0.71 L)	6"	5.1"	5.70"	4.0 lb	15.2 cm	13 cm	14.5 cm	1.8 kg	12
FG9G5300*	CLR	Bouncer® Portioning Scoop for FG9G7800, FG9G7500 Sliding Lid	4 Cups (0.95 L)	6"	5.60"	6.60"	5.0 lb	15.2 cm	14.2 cm	16.8 cm	2.3 kg	12

*Certified to NSF Std. 2.

UTILITY REFUSE AND RECYCLING

DECORATIVE REFUSE

CLEANING & SAFETY

MATERIAL HANDLING

WASHROOM

FOODSERVICE

ACCESSORIES & INDEX



**ProSave® Ingredient Management System
BRUTE® INGREDIENT CONTAINERS AND SLIDING LIDS**

Designed for quick one-handed access to ingredients in a high-production facility.

- Rotating lid allows for one-handed access
- Dedicated internal scoop storage complies with food code for safe access
- Hook options for 32- and 64-oz. Contour Scoop allows for ingredient access flexibility
- Clear windows for fast ingredient identification and inventory management
- Certified to NSF/ANSI/3-A and 2 Standards
- Commercial dishwasher-safe



Improve safety compliance with dedicated internal scoop storage.



Enhance food production efficiency with rotating clear lid.



FG264000
Dolly



FG9G7600 /
FG9G7700 /
FG9G7800
Sliding Lid



FG9G7300
150 Cups
47 lb flour



FG9G7400
300 Cups
94 lb flour



FG9G7500
500 Cups
156 lb flour

ProSave® Ingredient Container Lids

NO.	COLOR	DESCRIPTION	DEPTH	WIDTH	HEIGHT	CASE WEIGHT (LB TO KG)	CASE PACK
FG9G7600	WHT	Sliding Lid with 2-Cup Scoop (fits FG261088 BRUTE® Container)	17"	17"	4.75"	3.04 lb (1.38 kg)	1
FG9G7700	WHT	Sliding Lid with 3-Cup Scoop (fits FG262088 BRUTE® Container)	20.75"	20.75"	5"	4.30 lb (1.95 kg)	1
FG9G7800	WHT	Sliding Lid with 4-Cup Scoop (fits FG263288 BRUTE® Container)	23.50"	23.50"	5.25"	5.25 lb (2.38 kg)	1

ProSave® Ingredient Container Combos

NO.	COLOR	DESCRIPTION	GALLONS (LITERS)	CUPS (LITERS)	CUBIC FT ³ (METERS M ³)	FLOUR LB (KG)	SUGAR LB (KG)	DEPTH	WIDTH	HEIGHT	CASE WEIGHT (LB/KG)	CASE PACK
FG9G7300	WHT	Sliding Lid w/ 2-Cup Scoop and FG261088 BRUTE® Container COMBO	10 (37.85)	150 (35.49)	1.33 (0.04)	47 (21)	65 (29)	15.63"	15.63"	17.13"	19.0 lb (8.62 kg)	6
FG9G7400	WHT	Sliding Lid w/ 3-Cup Scoop and FG262088 BRUTE® Container COMBO	20 (75.70)	300 (70.98)	2.66 (0.08)	94 (43)	130 (59)	19.50"	19.50"	22.88"	35.0 lb (15.88 kg)	6
FG9G7500	WHT	Sliding Lid w/ 4-Cup Scoop and FG263288 BRUTE® Container COMBO	32 (121.12)	500 (118.29)	4.28 (0.12)	156 (71)	217 (98)	22"	22"	27.25"	49.5 lb (22.45 kg)	6

ProSave® Ingredient Containers

NO.	COLOR	DESCRIPTION	GALLONS (LITERS)	CUPS (LITERS)	CUBIC FT ³ (METERS M ³)	FLOUR LB (KG)	SUGAR LB (KG)	DEPTH	WIDTH	HEIGHT	CASE WEIGHT (LB TO KG)	CASE PACK
FG261088	WHT	BRUTE® Container without Lid	10 (37.85)	150 (35.49)	1.33 (0.04)	47 (21)	65 (29)	15.63"	15.63"	17.13"	19.0 lb (8.62 kg)	6
FG262088	WHT	BRUTE® Container without Lid	20 (75.70)	300 (70.98)	2.66 (0.08)	94 (43)	130 (59)	19.50"	19.50"	22.88"	35.0 lb (15.88 kg)	6
FG263288	WHT	BRUTE® Container without Lid	32 (121.12)	500 (118.29)	4.28 (0.12)	156 (71)	217 (98)	22"	22"	27.25"	49.5 lb (22.45 kg)	6
FG264000	BLA	BRUTE® Dolly for FG9G7400, FG9G7500, FG262088, and FG263288						18.25"	18.25"	6.63"	13.1 lb (5.94 kg)	2

When ordering products with **BOLD** color codes, please specify color code after the product number. Refer to the Standard Color Guide at the back of the catalog.

UTILITY REFUSE AND RECYCLING

DECORATIVE REFUSE

CLEANING & SAFETY

MATERIAL HANDLING

WASHROOM

FOODSERVICE

ACCESSORIES & INDEX



UTILITY REFUSE
AND RECYCLING

DECORATIVE REFUSE

CLEANING
& SAFETY

MATERIAL HANDLING

WASHROOM

FOODSERVICE

ACCESSORIES
& INDEX

Food Boxes

Durable storage solution for food as it flows throughout your facility.

- Crystal-clear material is stain- and odor-resistant and allows for visibility of food contents and quality
- White polyethylene containers provide durable and practical solution
- Texturing on corners and base reduces scratching
- Labeling window visible on bases and lids for date and information coding
- Available in standard sizes of 18" x 12" and 26" x 18"

SOLID FLAT LIDS

- Durable lids snap tightly into place during transport and keep foods fresh
- Use lid as a tray when displayed upside down
- Available in crystal-clear material or white polyethylene



FG330000 and F330200



Crystal-Clear Food Boxes and Lids

NO.	COLOR	DESCRIPTION	U.S. CAPACITY	U.S. DIMENSIONS	U.S. SHIP WT/CTN	METRIC CAPACITY	METRIC DIMENSIONS	METRIC SHIP WT/CTN	CASE PACK
FG330600	CLR	Food/Tote Box	5 gal	26" l x 18" w x 3.5" d	21.5 lb	18.9 L	66 cm x 45.7 cm x 8.9 cm	9.8 kg	6
FG330800	CLR	Food/Tote Box	8½ gal	26" l x 18" w x 6" d	30.0 lb	32.2 L	66 cm x 45.7 cm x 15.2 cm	13.6 kg	6
FG330000	CLR	Food/Tote Box	12½ gal	26" l x 18" w x 9" d	42.9 lb	47.3 L	66 cm x 45.7 cm x 22.9 cm	19.5 kg	6
FG332800	CLR	Food/Tote Box	16⅔ gal	26" l x 18" w x 12" d	54.9 lb	62.9 L	66 cm x 45.7 cm x 30.5 cm	24.9 kg	6
FG330100	CLR	Food/Tote Box	21½ gal	26" l x 18" w x 15" d	66.9 lb	81.4 L	66 cm x 45.7 cm x 38.1 cm	30.3 kg	6
FG330200	CLR	Lid for FG330000, FG330100, FG330600, FG330800, FG332800 Food/Tote Boxes	N/A	26" l x 18" w	16.9 lb	N/A	66 cm x 45.7 cm	7.7 kg	6
FG330700	CLR	Food/Tote Box	2 gal	18" l x 12" w x 3.5" d	10.4 lb	7.6 L	45.7 cm x 30.5 cm x 8.9 cm	4.7 kg	6
FG330900	CLR	Food/Tote Box	3½ gal	18" l x 12" w x 6" d	18.0 lb	13.2 L	45.7 cm x 30.5 cm x 15.2 cm	8.2 kg	6
FG330400	CLR	Food/Tote Box	5 gal	18" l x 12" w x 9" d	22.1 lb	18.9 L	45.7 cm x 30.5 cm x 22.9 cm	10 kg	6
FG331000	CLR	Lid for FG330400, FG330700, FG330900 Food/Tote Boxes	N/A	18" l x 12" w	7.6 lb	N/A	45.7 cm x 30.5 cm	3.4 kg	6
FG331400	CLR	Drain Tray	N/A	18" l x 12" w	3.5 lb	N/A	45.7 cm l x 30.5 cm w	1.59 kg	6
FG331800	CLR	Drain Tray	N/A	26" l x 18" w	2.9 lb	N/A	66 cm l x 45.7 cm w	1.32 kg	6
FG330300	CLR	Colander for Tote Boxes 6" deep or greater	N/A	26" l x 18" w x 5" d	26.7 lb	N/A	66 cm l x 45.7 cm w x 12.7 cm	12.21 kg	6

Polyethylene Food Boxes and Lids

NO.	COLOR	DESCRIPTION	U.S. CAPACITY	U.S. DIMENSIONS	U.S. SHIP WT/CTN	METRIC CAPACITY	METRIC DIMENSIONS	METRIC SHIP WT/CTN	CASE PACK
FG350600	WHT	Food/Tote Box	5 gal	26" l x 18" w x 3.5" d	18.1 lb	18.9 L	66 cm x 45.7 cm x 8.9 cm	8.2 kg	6
FG350800	WHT	Food/Tote Box	8½ gal	26" l x 18" w x 6" d	23.3 lb	32.2 L	66 cm x 45.7 cm x 15.2 cm	10.5 kg	6
FG350000	WHT	Food/Tote Box	12½ gal	26" l x 18" w x 9" d	31.7 lb	47.3 L	66 cm x 45.7 cm x 22.9 cm	14.4 kg	6
FG352800	WHT	Food/Tote Box	16⅔ gal	26" l x 18" w x 12" d	41.8 lb	62.9 L	66 cm x 45.7 cm x 30.5 cm	19 kg	6
FG350100	WHT	Food/Tote Box	21½ gal	26" l x 18" w x 15" d	52.9 lb	81.4 L	66 cm x 45.7 cm x 38.1 cm	24 kg	6
FG350200	WHT	Lid for FG350000, FG350100, FG350600, FG350800, FG352800 Food/Tote Boxes	N/A	26" l x 18" w	14.8 lb	N/A	66 cm x 45.7 cm	6.7 kg	6
FG350700	WHT	Food/Tote Box	2 gal	18" l x 12" w x 3.5" d	8.2 lb	7.6 L	45.7 cm x 30.5 cm x 8.9 cm	3.7 kg	6
FG350900	WHT	Food/Tote Box	3½ gal	18" l x 12" w x 6" d	14.0 lb	13.2 L	45.7 cm x 30.5 cm x 15.2 cm	6.4 kg	6
FG350400	WHT	Food/Tote Box	5 gal	18" l x 12" w x 9" d	17.2 lb	18.9 L	45.7 cm x 30.5 cm x 22.9 cm	7.8 kg	6
FG351000	WHT	Lid for FG350400, FG350700, FG350900 Food/Tote Boxes	N/A	18" l x 12" w	7.1 lb	N/A	45.7 cm x 30.5 cm	3.2 kg	6

FreshWorks™ Produce Saver

The RCP FreshWorks™ Produce Saver Keeps Produce Fresher Longer.*

- Patented Filter regulates the flow of oxygen and ethylene, keeping lettuce fresh up to 2X longer**
- Filter never needs to be changed or replaced
- Built in drain tray elevates produce from any residual moisture to promote air flow
- Air tight lid helps create the perfect environment within the container
- Heavy Duty Polycarbonate lid and base
- Dishwasher-safe

*Based on produce stored in RCP FreshWorks™ vs traditional food box

**Based on romaine lettuce stored in RCP FreshWorks™ vs. traditional food box



NO.	COLOR	DESCRIPTION	U.S. CAPACITY	U.S. DIMENSIONS	U.S. SHIP WT/CTN	METRIC CAPACITY	METRIC DIMENSIONS	METRIC SHIP WT/CTN	CASE PACK
2052879	CLR	FreshWorks™ Produce Set	3 g	18.0" l x 12.0" w x 6.8" h	16.01 lb	11.36 L	45.72 cm x 30.48 cm x 17.23 cm	7.26 kg	4
2052933	CLR	FreshWorks™ Produce Set	5 g	18.0" l x 12.0" w x 9.8" h	19.88 lb	18.93 L	45.72 cm x 30.48 cm x 24.89 cm	9.02 kg	4
2052931	CLR	FreshWorks™ Produce Set	8 g	26.0" l x 18.0" w x 6.8" h	31.20 lb	30.28 L	66.04 cm x 45.72 cm x 17.23 cm	14.15 kg	4
2052878	CLR	FreshWorks™ Produce Set	12 g	26.0" l x 18.0" w x 9.8" h	37.97 lb	45.42 L	66.04 cm x 45.72 cm x 24.89 cm	17.22 kg	4
2052936	WHT	FreshWorks™ Produce Lid	3/5 g	18.0" l x 12.0" w x 1.2" h	5.32 lb	N/A	45.72 cm x 30.48 cm x 3.17 cm	2.41 kg	4
2052934	WHT	FreshWorks™ Produce Lid	8/12 g	26.0" l x 18.0" w x 1.3" h	11.26 lb	N/A	66.04 cm x 45.72 cm x 3.19 cm	5.11 kg	4
2052935	CLR	FreshWorks™ Produce Base	3 g	18.0" l x 12.0" w x 6.3" h	10.69 lb	11.36 L	45.72 cm x 30.28 cm x 16.08 cm	4.85 kg	4
2052932	CLR	FreshWorks™ Produce Base	5 g	18.0" l x 12.0" w x 9.3" h	14.56 lb	18.93 L	45.71 cm x 30.48 cm x 23.74 cm	6.60 kg	4
2052983	CLR	FreshWorks™ Produce Base	8 g	26.0" l x 18.0" w x 6.3" h	19.94 lb	30.28 L	66.03 cm x 45.71 cm x 16.08 cm	9.05 kg	4
2052880	CLR	FreshWorks™ Produce Base	12 g	26.0" l x 18.0" w x 9.3" h	26.71 lb	45.42 L	66.03 cm x 45.71 cm x 23.74 cm	12.12 kg	4



Space-Saving Square Containers

Stackable containers store more in less space.

- Square containers store a minimum of 25% more on a shelf than round containers
- Available in break-resistant, crystal-clear material for visibility
- Manage food inventory with easy-to-read measurement graduations—red for quarts and blue for liters
- Durable handles for easy transport and drain holes for proper washing and drying
- Temperature range for clear containers: -40°F to 212°F (-40°C to 100°C)
- Temperature range for white containers: -20°F to 150°F (-29°C to 66°C)
- Assists in complying with HACCP guidelines
- NSF 3-A Meat and Poultry Equipment and NSF 2-certified
- Commercial dishwasher-safe



Polycarbonate Square Storage Containers



FG650900 / FG630200 FG650900 / FG630400 FG650900 / FG630600 FG650900 / FG630800 FG652300 / FG631200 FG652300 / FG631800 FG652300 / FG632200

Crystal-Clear Square Storage Containers

NO.	COLOR	DESCRIPTION	U.S. CAPACITY	U.S. DIMENSIONS	U.S. SHIP WT/CTN	METRIC CAPACITY	METRIC DIMENSIONS	METRIC SHIP WT/CTN	CASE PACK
FG630200	CLR	Space-Saving Square Container	2 qt	8.75" l x 8.8" w x 2.69" h	7.03 lb	1.9 L	22.2 cm x 22.4 cm x 6.8 cm	3.2 kg	12
FG630400	CLR	Space-Saving Square Container	4 qt	8.75" l x 8.8" w x 4.75" h	10.44 lb	3.8 L	22.2 cm x 22.4 cm x 12.1 cm	4.7 kg	12
FG630600	CLR	Space-Saving Square Container	6 qt	8.75" l x 8.8" w x 6.94" h	14.06 lb	5.7 L	22.2 cm x 22.4 cm x 17.6 cm	6.4 kg	12
FG630800	CLR	Space-Saving Square Container	8 qt	8.75" l x 8.8" w x 8.75" h	9.415 lb	7.6 L	22.2 cm x 22.4 cm x 22.2 cm	4.3 kg	6
FG631200	CLR	Space-Saving Square Container	12 qt	11.31" l x 10.5" w x 7.75" h	10.97 lb	11.4 L	28.7 cm x 26.7 cm x 19.7 cm	5 kg	6
FG631800	CLR	Space-Saving Square Container	18 qt	11.31" l x 10.5" w x 11.94" h	17.22 lb	17 L	28.7 cm x 26.7 cm x 30.3 cm	7.8 kg	6
FG632200	CLR	Space-Saving Square Container	22 qt	11.31" l x 10.5" w x 14.44" h	22.96 lb	20.8 L	28.7 cm x 26.7 cm x 36.7 cm	10.4 kg	6

Square Container Lids

Use color-coded storage containers and lids to keep uncooked foods like raw meat separate from ready-to-eat foods.

- Leak-resistant, snap-tight lids
- Corner pull tabs for easy lid removal



COLORS AVAILABLE:



FG650900WHT 1980200 1980301
1980302 1980303 1980304

Square Container Lids

NO.	COLOR	DESCRIPTION	SIZE	U.S. DIMENSIONS	U.S. SHIP WT/CTN	METRIC DIMENSIONS	METRIC SHIP WT/CTN	CASE PACK
FG650900WHT	White	Color-Coded Square Container Lid	Fits 2, 4, 6, & 8 qt	9.00" l x 8.47" w x 0.51" h	3.09 lb	228.63 mm x 215.14 mm x 12.95 mm	1.40 kg	12
1980200	Red	Color-Coded Square Container Lid	Fits 2, 4, 6, & 8 qt	9.00" l x 8.47" w x 0.51" h	3.09 lb	228.63 mm x 215.14 mm x 12.95 mm	1.40 kg	12
1980301	Green	Color-Coded Square Container Lid	Fits 2, 4, 6, & 8 qt	9.00" l x 8.47" w x 0.51" h	3.09 lb	228.63 mm x 215.14 mm x 12.95 mm	1.40 kg	12
1980302	Blue	Color-Coded Square Container Lid	Fits 2, 4, 6, & 8 qt	9.00" l x 8.47" w x 0.51" h	3.09 lb	228.63 mm x 215.14 mm x 12.95 mm	1.40 kg	12
1980303	Yellow	Color-Coded Square Container Lid	Fits 2, 4, 6, & 8 qt	9.00" l x 8.47" w x 0.51" h	3.09 lb	228.63 mm x 215.14 mm x 12.95 mm	1.40 kg	12
1980304	Purple	Color-Coded Square Container Lid	Fits 2, 4, 6, & 8 qt	9.00" l x 8.47" w x 0.51" h	3.09 lb	228.63 mm x 215.14 mm x 12.95 mm	1.40 kg	12
FG652300WHT	White	Color-Coded Square Container Lid	Fits 12, 18, & 22 qt	11.56" l x 10.68" w x 0.52" h	2.26 lb	293.67 mm x 271.25 mm x 13.21 mm	1.02 kg	6
1980307	Red	Color-Coded Square Container Lid	Fits 12, 18, & 22 qt	11.56" l x 10.68" w x 0.52" h	2.26 lb	293.67 mm x 271.25 mm x 13.21 mm	1.02 kg	6
1980308	Green	Color-Coded Square Container Lid	Fits 12, 18, & 22 qt	11.56" l x 10.68" w x 0.52" h	2.26 lb	293.67 mm x 271.25 mm x 13.21 mm	1.02 kg	6
1980309	Blue	Color-Coded Square Container Lid	Fits 12, 18, & 22 qt	11.56" l x 10.68" w x 0.52" h	2.26 lb	293.67 mm x 271.25 mm x 13.21 mm	1.02 kg	6
1980310	Yellow	Color-Coded Square Container Lid	Fits 12, 18, & 22 qt	11.56" l x 10.68" w x 0.52" h	2.26 lb	293.67 mm x 271.25 mm x 13.21 mm	1.02 kg	6
1980311	Purple	Color-Coded Square Container Lid	Fits 12, 18, & 22 qt	11.56" l x 10.68" w x 0.52" h	2.26 lb	293.67 mm x 271.25 mm x 13.21 mm	1.02 kg	6

When ordering products with **BOLD** color codes, please specify color code after the product number. Refer to the Standard Color Guide at the back of the catalog.

UTILITY REFUSE AND RECYCLING

DECORATIVE REFUSE

CLEANING & SAFETY

MATERIAL HANDLING

WASHROOM

FOODSERVICE

ACCESSORIES & INDEX

Round Storage Containers

Store food safely and efficiently.

- Stackable handled containers available in white polyethylene or semi-clear polypropylene for better visibility
- Temperature range: 35°F to 150°F (2°C to 66°C)
- NSF 3-A and NSF 2-certified
- Dishwasher-safe



Semi-Clear Polypropylene Round Storage Containers

NO.	COLOR	DESCRIPTION	U.S. CAPACITY	U.S. DIMENSIONS	U.S. SHIP WT/CTN	METRIC CAPACITY	METRIC DIMENSIONS	METRIC SHIP WT/CTN	CASE PACK
FG572024	CLR	Round Storage Container	2 qt	8.5" dia x 4" h	4.3 lb	1.9 L	21.6 cm dia x 10.2 cm	2 kg	12
FG572124	CLR	Round Storage Container	4 qt	8.5" dia x 7.75" h	7.4 lb	3.8 L	21.6 cm dia x 19.7 cm	3.4 kg	12
FG572324	CLR	Round Storage Container	6 qt	10" dia x 7.63" h	8.7 lb	5.7 L	25.4 cm dia x 19.4 cm	3.9 kg	12
FG572424	CLR	Round Storage Container	8 qt	10" dia x 10.63" h	11.9 lb	7.6 L	25.4 cm dia x 27 cm	5.4 kg	12
FG572624	CLR	Round Storage Container	12 qt	13.13" dia x 8.13" h	8.5 lb	11.4 L	33.3 cm dia x 20.6 cm	3.9 kg	6
FG572724	CLR	Round Storage Container	18 qt	13.13" dia x 11.88" h	11.6 lb	17 L	33.3 cm dia x 30.2 cm	5.3 kg	6
FG572824	CLR	Round Storage Container	22 qt	13.13" dia x 14" h	14.8 lb	20.8 L	33.3 cm dia x 35.6 cm	6.7 kg	6
FG572924	CLR	Round Storage Container with Bail	22 qt	13.13" dia x 14" h	15.9 lb	20.8 L	33.3 cm dia x 35.6 cm	7.2 kg	6

Polyethylene Round Storage Containers

NO.	COLOR	DESCRIPTION	U.S. CAPACITY	U.S. DIMENSIONS	U.S. SHIP WT/CTN	METRIC CAPACITY	METRIC DIMENSIONS	METRIC SHIP WT/CTN	CASE PACK
FG572000	WHT	Round Storage Container	2 qt	8.5" dia x 4" h	4.3 lb	1.9 L	21.6 cm dia x 10.2 cm	2 kg	12
FG572100	WHT	Round Storage Container	4 qt	8.5" dia x 7.75" h	7.4 lb	3.8 L	21.6 cm dia x 19.7 cm	3.4 kg	12
FG572300	WHT	Round Storage Container	6 qt	10" dia x 7.63" h	8.7 lb	5.7 L	25.4 cm dia x 19.4 cm	3.9 kg	12
FG572400	WHT	Round Storage Container	8 qt	10" dia x 10.63" h	11.9 lb	7.6 L	25.4 cm dia x 27 cm	5.4 kg	12
FG572600	WHT	Round Storage Container	12 qt	13.13" dia x 8.13" h	8.5 lb	11.4 L	33.3 cm dia x 20.6 cm	3.9 kg	6
FG572700	WHT	Round Storage Container	18 qt	13.13" dia x 11.88" h	11.6 lb	17 L	33.3 cm dia x 30.2 cm	5.3 kg	6
FG572800	WHT	Round Storage Container	22 qt	13.13" dia x 14" h	15.2 lb	20.8 L	33.3 cm dia x 35.6 cm	6.9 kg	6
FG572900	WHT	Round Storage Container with Bail	22 qt	13.13" dia x 14" h	16.6 lb	20.8 L	33.3 cm dia x 35.6 cm	7.5 kg	6

Round Container Lids

Use color-coded storage containers and lids to keep uncooked foods like raw meat separate from ready-to-eat foods.

- Secure, leak-resistant lids
- Positive-lock lids (double-wall seal) with pull tabs



COLORS AVAILABLE:



Round Container Lids

NO.	COLOR	DESCRIPTION	SIZE	U.S. DIMENSIONS	U.S. SHIP WT/CTN	METRIC DIMENSIONS	METRIC SHIP WT/CTN	CASE PACK
1980337	Red	Color-Coded Round Container Lid	Fits 4 qt	8.80" l x 8.80" w x 0.90" h	2.47 lb	223.47 mm x 223.47 mm x 22.86 mm	1.12 kg	12
1980338	Green	Color-Coded Round Container Lid	Fits 4 qt	8.80" l x 8.80" w x 0.90" h	2.47 lb	223.47 mm x 223.47 mm x 22.86 mm	1.12 kg	12
1980339	Blue	Color-Coded Round Container Lid	Fits 4 qt	8.80" l x 8.80" w x 0.90" h	2.47 lb	223.47 mm x 223.47 mm x 22.86 mm	1.12 kg	12
FG572200YEL	Yellow	Color-Coded Round Container Lid	Fits 4 qt	8.80" l x 8.80" w x 0.90" h	2.47 lb	223.47 mm x 223.47 mm x 22.86 mm	1.12 kg	12
1980257	Purple	Color-Coded Round Container Lid	Fits 4 qt	8.80" l x 8.80" w x 0.90" h	2.47 lb	223.47 mm x 223.47 mm x 22.86 mm	1.12 kg	12
1980260	Red	Color-Coded Round Container Lid	Fits 8 qt	10.30" l x 10.30" w x 1.00" h	3.23 lb	261.57 mm x 261.57 mm x 25.40 mm	1.47 kg	12
1980381	Green	Color-Coded Round Container Lid	Fits 8 qt	10.30" l x 10.30" w x 1.00" h	3.23 lb	261.57 mm x 261.57 mm x 25.40 mm	1.47 kg	12
1980382	Blue	Color-Coded Round Container Lid	Fits 8 qt	10.30" l x 10.30" w x 1.00" h	3.23 lb	261.57 mm x 261.57 mm x 25.40 mm	1.47 kg	12
FG572500YEL	Yellow	Color-Coded Round Container Lid	Fits 8 qt	10.30" l x 10.30" w x 1.00" h	3.23 lb	261.57 mm x 261.57 mm x 25.40 mm	1.47 kg	12
1980384	Purple	Color-Coded Round Container Lid	Fits 8 qt	10.30" l x 10.30" w x 1.00" h	3.23 lb	261.57 mm x 261.57 mm x 25.40 mm	1.47 kg	12
1980387	Red	Color-Coded Round Container Lid	Fits 12 qt	13.52" l x 13.52" w x 1.20" h	3.35 lb	343.48 mm x 343.48 mm x 30.48 mm	1.52 kg	6
1980388	Green	Color-Coded Round Container Lid	Fits 12 qt	13.52" l x 13.52" w x 1.20" h	3.35 lb	343.48 mm x 343.48 mm x 30.48 mm	1.52 kg	6
1980389	Blue	Color-Coded Round Container Lid	Fits 12 qt	13.52" l x 13.52" w x 1.20" h	3.35 lb	343.48 mm x 343.48 mm x 30.48 mm	1.52 kg	6
FG573000YEL	Yellow	Color-Coded Round Container Lid	Fits 12 qt	13.52" l x 13.52" w x 1.20" h	3.35 lb	343.48 mm x 343.48 mm x 30.48 mm	1.52 kg	6
1980391	Purple	Color-Coded Round Container Lid	Fits 12 qt	13.52" l x 13.52" w x 1.20" h	3.35 lb	343.48 mm x 343.48 mm x 30.48 mm	1.52 kg	6



Heavy-Duty Hot and Cold Food Pans

Streamline your operations for storage, preparation, cooking, and serving.

- Break-resistant – won't rust, dent, or bend
- Odor-resistant
- Stain-resistant
- Nonstick surfaces for easy food release and cleaning
- FDA-approved for food contact
- NSF/ANSI/3-A and 2-Certified
- EU-Certified
- Designed to EN 631-1 C.E.N. Standard*
- Soft-sealing and secure sealing lids are temperature rated from -20°F to 150°F (-29°C to 66°C)
- Dishwasher-safe



Cold Food Pans

- Temperature rated: -40°F to 212°F (-40°C to 100°C)
- Not for use in steam table wells

Hot Food Pans

- Temperature rated: -40°F to 375°F (-40°C to 191°C)
- Steam table well-, oven-** and microwave-safe
- Not for use with open flame
- Cooler to the touch than metal
- Approved for use in continuous motion pot-washing systems



Hot pans are cool to the touch.



Nonstick surfaces for easy food release and cleaning.



LIDS FOR EVERY NEED

1 PEG HOLE COVER WITH HANDLE

Peg hole allows pan to be hung and dry faster, helping to prevent health risks from standing water. Rubbermaid Commercial Product's peg hole solution is the only NSF-certified hanging solution on the market.

2 NOTCHED COVER WITH HANDLE

NSF-certified notch allows spoon to be easily available while food remains covered. Notch keeps spoon handle out of food, complying with FDA Food Code.

3 SOFT-SEALING LID

Seals on insert pan help reduce airflow to food, therefore maintaining food quality. No overlap on food pans allows easy use in transport.

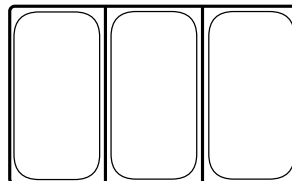

*DESIGNED TO EN 631-1 C.E.N. STANDARD

Developed by the European Committee for Standardization and based on a gastronorm modular system, ensures compatibility of the pans with other kitchen equipment.

**Oven-safe up to 375°F (191°C).



FG117P00 Clear



FG217P00 Amber



FOOD PANS

FOOD PANS									COLD PANS		HOT PANS	
U.S. SIZE	U.S. PAN DEPTH/ DESCRIPTION	U.S. CAPACITY	U.S. SHIP WT/CTN	METRIC SIZE	METRIC PAN DEPTH	METRIC CAPACITY	METRIC SHIP WT/ CTN	CASE PACK	ITEM NUMBER	COLOR	ITEM NUMBER	COLOR
Full Size 20 ¹³ / ₁₆ " l x 12 ¹³ / ₁₆ " w 	2 1/2"	9 qt	12.8 lb	Full Size	65 mm	8.5 L	5.8 kg	6	FG130P00	CLR	FG230P00	AMBR
	4"	13 3/4 qt	17.87 lb	530 mm x 325 mm	100 mm	13 L	3.6 kg	6	FG131P00	CLR	FG231P00	AMBR
	6"	20 5/8 qt	20.30 lb		150 mm	19.5 L	9.2 kg	6	FG132P00	CLR	FG232P00	AMBR
	8"	27 1/8 qt	24.52 lb		200 mm	25.7 L	11.1 kg	6	FG133P00	CLR		
	Handled Cover		10.21 lb				4.6 kg	6	FG134P00	CLR	FG234P00	AMBR
	Handled Notched Cover		9.37 lb				4.3 kg	6	FG134P86	CLR		
Soft-Sealing Lid		12.13 lb				5.5 kg	12	FG147P00	WHT			
1/2 Size LONG 20 ¹³ / ₁₆ " l x 6 ³ / ₈ " w 	2 1/2"	3 3/8 qt	8.33 lb	1/2 Size LONG	65 mm	3.4 L	3.8 kg	6	FG139P00	CLR	FG239P00	AMBR
	4"	5 1/2 qt	9.40 lb	530 mm x 162 mm	100 mm	5.2 L	4.3 kg	6	FG140P00	CLR	FG240P00	AMBR
	Handled Cover		4.77 lb				2.2 kg	6	FG141P00	CLR	FG241P00	AMBR
1/2 Size 12 ¹³ / ₁₆ " l x 10 ³ / ₈ " w 	2 1/2"	4 qt	6.30 lb	1/2 Size	65 mm	3.8 L	2.9 kg	6	FG123P00	CLR	FG223P00	AMBR
	4"	6 3/8 qt	7.65 lb	325 mm x 265 mm	100 mm	6 L	3.5 kg	6	FG124P00	CLR	FG224P00	AMBR
	6"	9 1/8 qt	9.90 lb		150 mm	8.8 L	4.5 kg	6	FG125P00	CLR	FG225P00	AMBR
	8"	11 3/8 qt	13.47 lb		200 mm	10.8 L	6.1 kg	6	FG126P00	CLR		
	Drain Tray		2.0 lb				0.9 kg	6	FG127P24*	CLR	FG127P00	AMBR
	Handled Cover w/ Peg Hole		4.3 lb				2 kg	6	FG128P23	CLR	FG228P23	AMBR
	Handled Notched Cover		4.3 lb				2 kg	6	FG128P86	CLR	FG228P86	AMBR
Soft-Sealing Lid		6.75 lb				3.1 kg	12	FG146P00	WHT			
1/2 Size 20 ¹³ / ₁₆ " l x 6 ⁷ / ₈ " w 	2 1/2"	2 5/8 qt	4.40 lb	1/2 Size	65 mm	2.5 L	2 kg	6	FG116P00	CLR	FG216P00	AMBR
	4"	4 qt	5.50 lb	325 mm x 176 mm	100 mm	3.8 L	2.5 kg	6	FG117P00	CLR	FG217P00	AMBR
	6"	5 3/8 qt	7.30 lb		150 mm	5.1 L	3.3 kg	6	FG118P00	CLR	FG218P00	AMBR
	8"	7 3/8 qt	9.60 lb		200 mm	7 L	4.4 kg	6	FG119P00	CLR		
	Drain Tray		1.50 lb				0.7 kg	6	FG120P24*	CLR	FG120P00	AMBR
	Handled Cover w/ Peg Hole		2.77 lb				1.3 kg	6	FG121P23	CLR	FG221P23	AMBR
	Handled Notched Cover		3.10 lb				1.4 kg	6	FG121P86	CLR	FG221P86	AMBR
	Soft-Sealing Lid		3.75 lb				1.7 kg	12	FG145P00	WHT		
1/4 Size 10 ³ / ₈ " l x 6 ³ / ₈ " w 	2 1/2"	1 3/8 qt	3.4 lb	1/4 Size	65 mm	1.6 L	1.5 kg	6	FG110P00	CLR	FG210P00	AMBR
	4"	2 1/2 qt	4.4 lb	265 mm x 162 mm	100 mm	2.4 L	2 kg	6	FG111P00	CLR	FG211P00	AMBR
	6"	4 qt	5.6 lb		150 mm	3.8 L	2.5 kg	6	FG112P00	CLR	FG212P00	AMBR
	Drain Tray		0.9 lb				0.4 kg	6	FG113P24	CLR	FG113P00	AMBR
	Handled Cover		2.1 lb				1 kg	6	FG114P00	CLR	FG214P00	AMBR
	Handled Notched Cover		2.1 lb				1 kg	6	FG114P86	CLR	FG214P86	AMBR
Soft-Sealing Lid		2.54 lb				1.2 kg	12	FG144P00	WHT			
1/6 Size 6 ⁷ / ₈ " l x 6 ³ / ₈ " w 	2 1/2"	1 1/8 qt	2.57 lb	1/6 Size	65 mm	1.1 L	1.2 kg	6	FG104P00	CLR	FG204P00	AMBR
	4"	1 3/8 qt	3.0 lb	176 mm x 162 mm	100 mm	1.6 L	1.4 kg	6	FG105P00	CLR	FG205P00	AMBR
	6"	2 1/2 qt	3.9 lb		150 mm	2.4 L	1.8 kg	6	FG106P00	CLR	FG206P00	AMBR
	Drain Tray		1.47 lb				0.7 kg	6	FG108P23	CLR	FG345600	AMBR
	Handled Cover w/ Peg Hole		1.5 lb				0.7 kg	6	FG108P86	CLR	FG208P23	AMBR
	Handled Notched Cover		1.5 lb				0.7 kg	6	FG108P86	CLR	FG208P86	AMBR
Soft-Sealing Lid		3.0 lb				1.4 kg	12	FG143P00	WHT			
1/6 Size 6 ⁷ / ₈ " l x 4 ³ / ₈ " w 	2 1/2"	3/8 qt	2.0 lb	1/6 Size	65 mm	.6 L	0.9 kg	6	FG100P00	CLR	FG200P00	AMBR
	4"	3/8 qt	2.19 lb	176 mm x 108 mm	100 mm	.8 L	1 kg	6	FG101P00	CLR	FG201P00	AMBR
	6"	1 1/16 qt	2.8 lb	176 mm x 108 mm	149 mm	1.2 L	1.3 kg	6	2045316	CLR		
	Drain Tray		0.43 lb	118 mm x 56 mm	19 mm		0.2 kg	6	2045317	CLR		
	Cover w/ Peg Hole		0.87 lb				0.4 kg	6	FG102P23	CLR	FG202P23	AMBR
	Notched Cover		0.90 lb				0.4 kg	6	FG102P86	CLR		
	Soft-Sealing Lid		1.2 lb				0.5 kg	12	FG142P00	WHT		

*FG127P24 fits all but FG126P00 *FG120P24 fits all but FG119P00

UTILITY REFUSE
AND RECYCLING

DECORATIVE REFUSE

CLEANING
& SAFETY

MATERIAL HANDLING

WASHROOM

FOODSERVICE

ACCESSORIES
& INDEX



High-Heat Scrapers and Spoons

All-purpose scrapers and spoons are a necessity in every kitchen.

- Silicone blade and nylon handle resist temperatures to 500°F/260°C and help prevent burns
- Clean-Rest™ feature keeps blade off countertops, reducing cross-contamination
- Notched scraper blade cleanly scrapes sides of pans
- Blades are stain-resistant and will not scratch pans
- NSF-certified and commercial dishwasher-safe

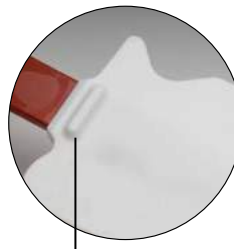

Clean-Rest™ reduces risk of cross-contamination.



Scraper Spoon



NO.	COLOR	DESCRIPTION	U.S. DIMENSIONS	U.S. SHIP WT/CTN	METRIC DIMENSIONS	METRIC SHIP WT/CTN	CASE PACK
FG196200	0000	Color Coded High-Heat Spatula (Red)	9.5" l	2.60 lb	24.1 cm	1.18 kg	24
1981140	Green	Color Coded High-Heat Spatula	9.5" l	2.60 lb	24.1 cm	1.18 kg	12
1981141	Blue	Color Coded High-Heat Spatula	9.5" l	2.60 lb	24.1 cm	1.18 kg	12
1981142	Yellow	Color Coded High-Heat Spatula	9.5" l	2.60 lb	24.1 cm	1.18 kg	12
1981143	Purple	Color Coded High-Heat Spatula	9.5" l	2.60 lb	24.1 cm	1.18 kg	12
FG196300	0000	Color Coded High-Heat Spatula (Red)	13.5" l	3.94 lb	34.3 cm	1.79 kg	24
1980417	Green	Color Coded High-Heat Spatula	13.5" l	3.94 lb	34.3 cm	1.79 kg	12
1980418	Blue	Color Coded High-Heat Spatula	13.5" l	3.94 lb	34.3 cm	1.79 kg	12
1980419	Yellow	Color Coded High-Heat Spatula	13.5" l	3.94 lb	34.3 cm	1.79 kg	12
1980420	Purple	Color Coded High-Heat Spatula	13.5" l	3.94 lb	34.3 cm	1.79 kg	12
FG196400	0000	High-Heat Scraper	16.5" l	7.03 lb	41.9 cm	3.2 kg	24
FG196600	RED	High-Heat Spoon Scraper	9.5" l	3.31 lb	24.1 cm	1.5 kg	24
FG196700	RED	High-Heat Spoon Scraper	13.5" l	6.58 lb	34.3 cm	3 kg	24
FG196800	RED	High-Heat Spoon Scraper	16.5" l	7.11 lb	41.9 cm	3.2 kg	24

Cold Scrapers and Spoons

Spoon, scrape, and spread with one easy tool.

- Blades are molded into handles for seamless construction that reduces buildup of dirt and bacteria
- Clean-Rest™ feature keeps blade off countertops, reducing cross-contamination
- NSF-certified and commercial dishwasher-safe

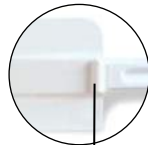

Clean-Rest™ reduces risk of cross-contamination.



Scraper Scraper-Icing Spoon



NO.	COLOR	DESCRIPTION	U.S. DIMENSIONS	U.S. SHIP WT/CTN	METRIC DIMENSIONS	METRIC SHIP WT/CTN	CASE PACK
FG190100	0000	Scraper	9.5" l	4.0 lb	24.1 cm	1.8 kg	36
FG190500	0000	Scraper	13.5" l	8.0 lb	34.3 cm	3.6 kg	36
FG190600	0000	Scraper	16.5" l	12.0 lb	41.9 cm	5.4 kg	36
FG191300	0000	Scraper-Icing Blade	9.5" l	4.0 lb	24.1 cm	1.8 kg	36
FG193300	WHT	Spoon-Shaped Spatula	9.5" l	4.61 lb	24.1 cm	2.1 kg	36
FG193400	WHT	Spoon-Shaped Spatula	13.5" l	9.22 lb	34.3 cm	4.2 kg	36
FG193800	WHT	Spoon-Shaped Spatula	16.5" l	11.1 lb	41.9 cm	5.0 kg	36

Measuring Cups and Spoons

- Made of FDA-compliant materials
- Capacities clearly engraved for easy identification
- Spoons are secured with detachable ring
- Accurate ingredient portioning to manage food costs
- Commercial dishwasher-safe



FG8316AS



FG8315AS



FG9G8200



NO.	COLOR	DESCRIPTION	U.S. CAPACITY	U.S. SHIP WT/CTN	METRIC SHIP WT/CTN	CASE PACK
FG8315AS	WHT	Measuring Cup Set	Set includes: ¼, ⅓, ½, and 1 cups	2.15 lb	0.98 kg	12
FG8316AS	WHT	Measuring Spoon Set	Set includes: ¼ tsp, ⅓ tsp, ½ tsp, 1 tsp, ½ tbsp, and 1 tbsp	1.0 lb	0.45 kg	12
FG9G8200	WHT	Measuring Scoop	½ cup	1.05 lb	0.48 kg	12

When ordering products with **BOLD** color codes, please specify color code after the product number. Refer to the Standard Color Guide at the back of the catalog.

UTILITY REFUSE AND RECYCLING

DECORATIVE REFUSE

CLEANING & SAFETY

MATERIAL HANDLING

WASHROOM

FOODSERVICE

ACCESSORIES & INDEX

Bouncer® Measuring Cups

Manage costly ingredients.

- Accurately measure liquid or dry ingredients to help save on food costs
- Break-resistant, crystal-clear material is durable
- Temperature range: -40°F to 212°F (-40°C to 100°C)
- Metric measurements marked in blue and cup measurements marked in red for easy-to-read measurements
- NSF-certified and commercial dishwasher-safe



NO.	COLOR	DESCRIPTION	U.S. CAPACITY	U.S. SHIP WT/CTN	METRIC CAPACITY	METRIC SHIP WT/CTN	CASE PACK
FG321000	CLR	Bouncer® Measuring Cup	1 cup	2.0 lb	0.2 L	0.9 kg	12
FG321500	CLR	Bouncer® Measuring Cup	1 pt	2.36 lb	0.5 L	1.1 kg	6
FG321600	CLR	Bouncer® Measuring Cup	1 qt	3.30 lb	0.9 L	1.5 kg	6
FG321700	CLR	Bouncer® Measuring Cup	2 qt	4.43 lb	1.9 L	2.0 kg	6
FG321800	CLR	Bouncer® Measuring Cup	4 qt	10.0 lb	3.8 L	4.5 kg	6

Bouncer® Scoops

Multipurpose scoops for use throughout food service operations.

- Durable crystal-clear material (FG288200, FG288400, FG288600) or break-resistant white polyethylene (FG288500) can be used for a variety of applications
- NSF-certified (FG288200, FG288400, FG288600, FG9F7500 and FG9F7600) and commercial dishwasher-safe
- Bouncer® Contour Scoop (FG9F7500 and FG9F7600) is designed for the ProSave® Ingredient Bin System; the contoured design keeps hands away from food, reducing cross-contamination



FG288400 / FG288200 / FG288600

Bouncer® Portioning Scoops

Maintain food safety while managing food costs.

- Hybrid scoop and measuring cup allow for portioning or measuring milliliters, cups, or ounces
- Anti-roll design to reduce risk of the handle rolling into the food and posing a contamination risk
- Break-resistant, crystal-clear material is durable
- Permanent textured gradations for dry and liquid measurements
- FG9G5100 and FG9G5200 are designed to fit ProSave® Shelf Ingredient Bins
- NSF-certified and commercial dishwasher-safe



Portioning Scoops



NO.	COLOR	DESCRIPTION	U.S. CAPACITY	U.S. SHIP WT/CTN	METRIC CAPACITY	METRIC SHIP WT/CTN	CASE PACK
FG288200*	CLR	Bouncer® Bar Scoop	6 oz	3.0 lb	0.2 L	1.4 kg	12
FG288400*	CLR	Bouncer® Utility Scoop	32 oz	6.4 lb	0.9 L	2.9 kg	12
FG288500	WHT	Utility Scoop	64 oz	3.4 lb	1.9 L	1.5 kg	6
FG288600*	CLR	Bouncer® Utility Scoop	64 oz	5.1 lb	1.9 L	2.3 kg	6
FG9F7500*	CLR	Bouncer® Contour Scoop for FG360088, FG360288, FG360388 Ingredient Bins (32-oz scoop)	32 oz	4.2 lb	0.9 L	1.9 kg	6
FG9F7600*	CLR	Bouncer® Contour Scoop for FG360088, FG360288, FG360388 Ingredient Bins (64-oz scoop)	64 oz	6.2 lb	1.9 L	2.8 kg	6
FG9G5100	CLR	Bouncer® Portioning Scoop – 2 Cup	2 cup/16 oz	3.2 lb	500 ml	1.5 kg	12
FG9G5200	CLR	Bouncer® Portioning Scoop – 3 Cup	3 cup/24 oz	4.0 lb	750 ml	1.8 kg	12
FG9G5300	CLR	Bouncer® Portioning Scoop – 4 Cup	4 cup/32 oz	5.0 lb	1000 ml	2.3 kg	12
FG9G5400	CLR	Bouncer® Portioning Scoop – 8 Cup	8 cup/64 oz	4.0 lb	2000 ml	1.8 kg	6

*Certified to NSF Std. 2.

BRUTE® GreensKeeper® Containers

For cleaning and storing any fruit or vegetable.

- All-in-one wash, drain, crisp, and storage system that aids compliance with HACCP guidelines
- Removable dolly allows easy transport
- Assists in complying with FDA Code 3-302, 15 for Washing Fruits and Vegetables



FG263600

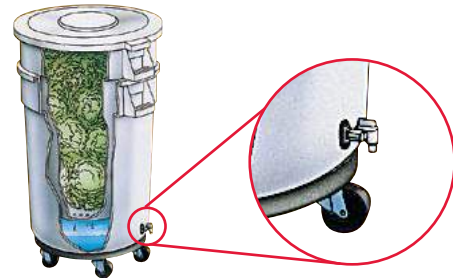

NO.	COLOR	DESCRIPTION	U.S. CAPACITY	U.S. DIMENSIONS	U.S. SHIP WT/CTN	METRIC CAPACITY	METRIC DIMENSIONS	METRIC SHIP WT/CTN	LETTUCE HEADS	CASE PACK
FG262400	WHT	GreensKeeper® Container with Lid and Dolly	20 gal	22.5" dia x 33.5" h	21.0 lb	75.7 L	57.2 cm dia x 85.1 cm	9.53 kg	27-30	1
FG263600	WHT	GreensKeeper® Container with Lid and Dolly	32 gal	25" dia x 38.5" h	29.1 lb	121.1 L	63.5 cm dia x 97.8 cm	13.2 kg	49-52	1



Premium Digital Portion Control Scale

Save money on high cost foods with digital portioning.

- Dishwasher-safe removable platform and outer housing
- Reads in pounds by fractional and decimal ounces and grams
- Temperature-compensated load cell for use in refrigerated prep rooms
- Sealed inner chassis resists airborne contamination, slides out for easy cleaning
- Antimicrobial outer shell (resin models only)
- Includes AC adapter; 50-hour rechargeable battery (included)
- Also may be used with AA batteries (not included)
- 1812595 comes with an oversized platform accessory



Dishwasher Safe



1812595

NO.	DESCRIPTION	INCREMENTS	U.S. CAPACITY	U.S. SHIP WT/CTN	METRIC CAPACITY	METRIC SHIP WT/CTN	CASE PACK
1812595	Premium Stainless Steel Dishwasher-Safe Digital Portion Control Scale (12 lb)	0.005 lb, 0.1 oz, 1/4 oz, 1 g	12.0 lb	25.0 lb	6000 g	11.3 kg	4

Digital Portion Control Scales

Save money on high-cost foods with digital portioning.

- Reads in pounds by fractional and decimal ounces and grams
- Temperature-compensated load cell for use in refrigerated prep rooms
- Antimicrobial protection on resin surfaces
- Available in 2-, 10-, 12-, and 24-lb capacities, with 200% overload protection
- Includes AC adapter
- High-Performance model uses AA batteries and Compact model uses AAA batteries



1812591

NO.	DESCRIPTION	INCREMENTS	U.S. CAPACITY	U.S. SHIP WT/CTN	METRIC CAPACITY	METRIC SHIP WT/CTN	CASE PACK
1812590	High-Performance Digital Portion Control Scale (2 lb)	0.005 lb, 0.1 oz, 1/4 oz, 1 g	2.0 lb	25.0 lb	1000 g	11.3 kg	1
1812591	High-Performance Digital Portion Control Scale (12 lb)	0.005 lb, 0.1 oz, 1/4 oz, 1 g	12.0 lb	16.9 lb	6000 g	7.7 kg	1
1812592	High-Performance Digital Portion Control Scale (24 lb)	0.01 lb, 0.2 oz, 1/2 oz, 10 g	24.0 lb	16.9 lb	12000 g	7.7 kg	1
1812588	Compact Digital Portion Control Scale (2 lb)	0.1 oz, 1/4 oz, 1 g	2.0 lb	5.8 lb	1000 g	2.6 kg	1
1812589	Compact Digital Portion Control Scale (10 lb)	0.1 oz, 1/4 oz, 1 g	10.0 lb	5.8 lb	5000 g	2.6 kg	1

UTILITY REFUSE AND RECYCLING

DECORATIVE REFUSE

CLEANING & SAFETY

MATERIAL HANDLING

WASHROOM

FOODSERVICE

ACCESSORIES & INDEX

Premium Mechanical Portion Control Scales

All premium mechanical scales.

- Platform serves as a handle
- Precise calibration at factory eliminates need for field recalibration
- Color-coded lens identifies scale capacity "at a glance"
- Removable platform for easy cleaning and HACCP



FG605SRW

FG632SRW

Stainless Steel Scales, Dishwasher-Safe

- QuickStop feature stops needle quickly on weight
- 100% dishwasher-safe, no tools required to disassemble
- 30° angled, easy-to-read, shatter-resistant lens
- Rotating dial for multiple ingredient weighing



Stainless Steel Scales, Dishwasher-Safe

NO.	DESCRIPTION	U.S. CAPACITY	INCREMENTS	PLATFORM SIZE	ROTATING DIAL	U.S. SHIP WT/CTN	OVER/UNDER DIAL	METRIC SHIP WT/CTN	CASE PACK
FG632SRW	Dishwasher-Safe Mechanical Portion Control Scale	32 oz	¼ oz	6" x 5.25"	Yes	30.0 lb	N/A	13.6 kg	1
FG605SRW	Dishwasher-Safe Mechanical Portion Control Scale	5 lb	½ oz	6" x 5.25"	Yes	30.0 lb	N/A	13.6 kg	1

Steel with Baked-Enamel Finish, Hand-Wash Scale

NO.	DESCRIPTION	U.S. CAPACITY	INCREMENTS	PLATFORM SIZE	ROTATING DIAL	U.S. SHIP WT/CTN	OVER/UNDER DIAL	METRIC SHIP WT/CTN	CASE PACK
FG832WQ	Washable Mechanical Portion Control Scale w/ QuickStop	32 oz	¼ oz	9" x 9"	Yes	42.0 lb	N/A	19.1 kg	1
FG832W	Washable Mechanical Portion Control Scale	32 oz	¼ oz	9" x 9"	Yes	42.0 lb	N/A	19.1 kg	1
FG810W	Washable Mechanical Portion Control Scale	10 lb	1 oz	9" x 9"	Yes	42.0 lb	N/A	19.1 kg	1
FG840W	Washable Mechanical Portion Control Scale	40 lb	2 oz	9" x 9"	Yes	42.0 lb	N/A	19.1 kg	1

Dual-Read With U.S. And Metric Dial Scale, Washable

NO.	DESCRIPTION	U.S. CAPACITY	INCREMENTS	PLATFORM SIZE	ROTATING DIAL	U.S. SHIP WT/CTN	METRIC CAPACITY	METRIC SHIP WT/CTN	CASE PACK
FG820BW	Washable Mechanical Portion Control Scale	20 lb	1 oz, 25 g	9" x 9"	Yes	42.0 lb	9 kg	19.1 kg	1

Mechanical Portion Control Scales

- Stainless steel platform and stanchion serve as built-in handle
- Extra-thick anodized aluminum chassis for durability
- Color-coded lens identifies scale capacity "at a glance"



FGY32R

Rotating Dial Scales

NO.	DESCRIPTION	U.S. CAPACITY	INCREMENTS	U.S. SHIP WT/CTN	PLATFORM SIZE	METRIC SHIP WT/CTN	CASE PACK
FGY16R	Mechanical Portion Control Scale	16 oz	¼ oz	23.0 lb	4.5" x 5.75"	10.4 kg	1
FGY32R	Mechanical Portion Control Scale	32 oz	¼ oz	23.0 lb	4.5" x 5.75"	10.4 kg	1
FGYG180R	Mechanical Portion Control Scale	5 lb	½ oz	23.0 lb	4.5" x 5.75"	10.4 kg	1
FGYG425R	Mechanical Portion Control Scale	25 lb	2 oz	23.0 lb	4.5" x 5.75"	10.4 kg	1
FGYG450R	Mechanical Portion Control Scale	50 lb	4 oz	23.0 lb	4.5" x 5.75"	10.4 kg	1

Compact Scales

NO.	DESCRIPTION	U.S. CAPACITY	INCREMENTS	U.S. SHIP WT/CTN	PLATFORM SIZE	METRIC SHIP WT/CTN	CASE PACK
FGK32	Oven-Run Scale with 1 pt Measuring Cup	32 oz	¼ oz	10.0 lb	3.75" x 4.25"	4.5 kg	1
FGK16SS	Compact Portion Control Scale	16 oz	¼ oz	8.0 lb	3.75" x 4.25"	3.6 kg	1
FGKF16SS	Compact Portion Control Scale with Contoured Platform	16 oz	¼ oz	10.0 lb	N/A	4.5 kg	1



Digital Receiving Utility Scales

Proper inventory control begins at the receiving door.

4010/4040 DIGITAL RECEIVING SCALES

- Rugged 18-gauge scale designed to handle heavy packages and containers
- Remote 1/2" LCD wall-mount display saves counter space and provides eye-level readout (9' cord reach) for employee-safe receiving
- Tare feature removes weight of container
- Low-profile, nonskid platform allows for easy weighing



FG401088 / FG404088



NO.	DESCRIPTION	INCREMENTS	U.S. CAPACITY	U.S. SHIP WT/CTN	METRIC CAPACITY	METRIC SHIP WT/CTN	CASE PACK
FG401088	Digital Receiving Scale	0.2 lb, 0.1 kg	150.0 lb	22.0 lb	68 kg	10 kg	1
FG404088	Digital Receiving Scale	0.5 lb, 0.2 kg	400.0 lb	22.0 lb	180 kg	10 kg	1

Briefcase Utility Mechanical Receiving Scales

Low-profile receiving scale for foodservice, industrial, or office environments.

- Multiribbed platform is sturdy enough for bulky crates or heavy cartons
- Memory Lock™ feature locks in weight when dial is secure
- Low platform design allows for cartons to easily slide onto scale, improving employee safety
- Protected zero-adjust knob for precise zero reset
- Nonskid feet ensure weighing stability



FGP100S



NO.	DESCRIPTION	INCREMENTS	U.S. CAPACITY	U.S. SHIP WT/CTN	METRIC CAPACITY	METRIC SHIP WT/CTN	CASE PACK
FGP100S	Briefcase Receiving Scale	1 lb	100.0 lb	20.0 lb	N/A	9.1 kg	1
FGP250S	Briefcase Receiving Scale	1 lb	250.0 lb	20.0 lb	N/A	9.1 kg	1
FGP250SS	Briefcase Receiving Scale	1 lb	250.0 lb	20.0 lb	N/A	9.1 kg	1

Fixed Dial Platform Receiving Scales

Heavy-duty platform scale for tabletop weighing

- Temperature-compensated for use in refrigerated prep rooms and throughout the flow of food
- 30° angled, easy-to-read, shatter-resistant lens
- Heavy-duty steel construction
- Zero-adjust knob for precise zero reset



Steel with Baked-Enamel Finish

NO.	DESCRIPTION	INCREMENTS	U.S. CAPACITY	U.S. SHIP WT/CTN	METRIC CAPACITY	METRIC SHIP WT/CTN	CASE PACK
FG10B100	Heavy-Duty Receiving Scale – Dual-Read	4 oz, 100 g	100.0 lb	52.0 lb	45 kg	23.6 kg	1
FG10200S	200 lb Heavy-Duty Receiving Scale	8 oz	200.0 lb	59.0 lb	N/A	26.8 kg	1

UTILITY REFUSE AND RECYCLING

DECORATIVE REFUSE

CLEANING & SAFETY

MATERIAL HANDLING

WASHROOM

FOODSERVICE

ACCESSORIES & INDEX

ProServe® Ice Handling System

Promotes safe transfer of ice to reduce risk of cross-contamination and improves employee safety.

ProServe® ICE TOTE WITH BIN HOOK ADAPTER

Adapter keeps tote off floor, reducing cross-contamination.

- Bin hook adapter attaches to ice machine for ease of transfer and reduced back strain
- Elevated base hand grip reduces cross-contamination
- Nonnesting and fits in most commercial dishwashers

ProServe® 74-OZ SCOOP

WITH HAND GUARD AND HOLDER

15% greater capacity than standard scoop.

- Ice cavity under handle protects ice
- Reinforced leading edge
- Open air holder for reduced mold and bacteria growth
- Commercial dishwasher-safe



Ice flow from corners reduces spillage and improves safety.



NO.	COLOR	DESCRIPTION	U.S. DIMENSIONS	U.S. SHIP WT/CTN	METRIC DIMENSIONS	METRIC SHIP WT/CTN	CASE PACK
FG9F4300 ¹	0000	Scoop Holder	10.1" l x 7.5" w x 5.4" h	5.83 lb	25.7 cm x 19.1 cm x 13.7 cm	2.6 kg	6
FG9F5000	TBLUE	74-oz Scoop with Hand Guard	12" l x 6.7" w x 7.7" h	7.1 lb	30.5 cm x 17 cm x 19.6 cm	3.2 kg	6
FG9F5100 ¹	TBLUE	74-oz Scoop with Hand Guard and Holder	12.1" l x 7.5" w x 8" h	2.25 lb	30.7 cm x 19.1 cm x 20.3 cm	1 kg	1
FG9F5300	TBLUE	Ice Tote	10.5" l x 13.3" w x 22.1" h	4.3 lb	26.7 cm x 33.8 cm x 56.1 cm	2 kg	1
FG9F5400	TBLUE	Ice Tote with Bin Hook Adapter	12.2" l x 13.3" w x 22.1" h	4.0 lb	31 cm x 33.8 cm x 56.1 cm	1.8 kg	1
FG9F5600	0000	Ice Bin Hook Adapter	9.9" l x 11.8" w x 1.7" h	2.9 lb	25.1 cm x 30 cm x 4.3 cm	1.3 kg	6
FG9F7300	BLA	Ice Tote Lid	12" l x 11.25" w x 2" h	2.4 lb	30.5 cm x 28.6 cm x 5.1 cm	1.1 kg	4

¹Holder is not NSF-listed.

BRUTE® "ICE ONLY" Container

Make ice safety a priority!

- Ensures safe ice handling and complies with HACCP guidelines
- No cracking, rusting, or chipping that could potentially contaminate ice
- Compliant with FDA Food Code 3-302.12 for Food Storage Containers with identifiably Common Food Name
- Handles and double-ribbed base allow easy lifting and dragging
- NSF-certified BRUTE® "ICE ONLY" container is durable and easy to clean



FG9F8600



NO.	COLOR	DESCRIPTION	U.S. CAPACITY	U.S. DIMENSIONS	U.S. SHIP WT/CTN	METRIC CAPACITY	METRIC DIMENSIONS	METRIC SHIP WT/CTN	CASE PACK
FG9F8600	WHT	"ICE ONLY" Container	10 gal	15.63" dia x 15.63" l x 17.13" h	19.0 lb	37.85 cm	39.7 cm dia x 39.7 cm x 43.5 cm	8.6 kg	6

UTILITY REFUSE AND RECYCLING

DECORATIVE REFUSE

CLEANING & SAFETY

MATERIAL HANDLING

WASHROOM

FOODSERVICE

ACCESSORIES & INDEX



ProServe® Lightweight Insulated Carriers

Four layers of thermal retention provide lightweight option for safely transporting food and beverages.

- Two inches of polyester insulation offers maximum thermal retention with no moisture and odor retention
- Keeps hot food hot and cold food cold safely for 4 hours
- ProServe® carriers are lighter than solid competitive products, decreasing risk of ergonomic stress
- Divider for FG9F1500 allows separation within carrier between hot and cold food storage
- Time temperature monitoring and labeling is easy with large identification window secured to each carrier



RIGID INTERIOR INSULATION

Lightweight and over 300% stronger than Styrofoam® polystyrene, Expanded Polypropylene (EPP) resists flaking, cleans easily, and provides uncompromising support.

NONWOVEN POLYESTER INSULATION

Nearly an inch thick, it's the same insulation used in high-performance cold-weather gear. Will not retain moisture or odors.

REFLECTIVE VAPOR BARRIER

Helps maintain even temperature throughout the carrier, so foods maintain their ideal temperatures.

COMMERCIAL-GRADE NYLON EXTERIOR

Strong (840 denier) nylon surrounds and protects the inner layers.



FG9G4000 Divider for FG9F1500 allows separation within carrier between hot and cold food storage and reduces risk of cross-contamination.

Heat Loss And Cold Retention

Weight Comparison

NO.	HEAT LOSS AND COLD RETENTION		WEIGHT COMPARISON		
	HEAT LOSS IN °F/HR* (°C/HR)	HEAT GAIN IN °F/HR* (°C/HR)	PROSERVE®	TRADITIONAL EQUIVALENT [†]	DIFFERENCE
FG9F1200	5.5°F (3.1°C)	+0.2°F (0.1°C)	10.6 lb	24.3 lb	56%
FG9F1300	6.0°F (3.3°C)	+0.4°F (0.2°C)	14.9 lb	28.7 lb	48%
FG9F1400	5.7°F (3.2°C)	+0.3°F (0.2°C)	17.0 lb	29.5 lb	52%
FG9F1500	5.8°F (3.2°C)	+0.5°F (0.3°C)	6.3 lb	26.5 lb	76%
FG9F1600	5.2°F (2.9°C)	+0.6°F (0.3°C)	11.1 lb	27.5 lb	60%

*Average calculated on the basis of a 4-hour period

[†]Traditional rigid containers



FG9F1600



FG9F1500



FG9F1400



FG9F1300



FG9F1200

ProServe® Insulated Carriers

NO.	COLOR	DESCRIPTION	U.S. DIMENSIONS	U.S. SHIP WT/CTN	METRIC DIMENSIONS	METRIC SHIP WT/CTN	PAN CAPACITY	CASE PACK
FG9F1200	CGRAY	ProServe® Insulated End-Load, Full-Pan Carrier, Small	27" l x 18.25" w x 16" h	13.0 lb	68.6 cm x 46.4 cm x 40.6 cm	5.90 kg	Three 2½" or two 4" deep pans	1
FG9F1300	CGRAY	ProServe® Insulated End-Load, Full-Pan Carrier, Medium	27" l x 19.5" w x 22.5" h	17.5 lb	68.6 cm x 49.5 cm x 57.2 cm	7.94 kg	Five 2½" or three 4" deep pans	1
FG9F1400	CGRAY	ProServe® Insulated End-Load, Full-Pan Carrier, Large	27" l x 21.5" w x 29" h	20.1 lb	68.6 cm x 54.6 cm x 73.7 cm	9.12 kg	Seven 2½" or four 4" deep pans	1
FG9F1500	CGRAY	ProServe® Insulated Top-Load, Half-Pan Carrier	19" l x 16.75" w x 15" h	8.3 lb	48.3 cm x 42.5 cm x 38.1 cm	3.76 kg	Three 2½" or two 4" deep pans	1
FG9F1600	CGRAY	ProServe® Insulated Top-Load, Full-Pan Carrier	28" l x 19.25" w x 19.5" h	14.0 lb	71.1 cm x 48.9 cm x 49.5 cm	6.35 kg	Five 2½" or three 4" deep pans	1

[†]Styrofoam® is a registered trademark of the Dow Chemical Company.

ProServe® Professional Delivery Bags

Reliable professional delivery bags for those on the go!

- Durable, commercial-grade nylon exterior will not deteriorate with use and offers years of performance
- Commercial-grade zippers and hook and loop closures protect food while metal grommets release excess steam to maintain food quality
- Large identification window allows for easy labeling of orders, dates, and temperatures
- Commercial dishwasher-safe, with hanging loop for proper drying



Metal grommets allow release of excess steam to prevent soggy food.



NO.	COLOR	DESCRIPTION	BAG CAPACITY	U.S. DIMENSIONS	U.S. SHIP WT/CTN	METRIC DIMENSIONS	METRIC SHIP WT/CTN	CASE PACK
FG9F3500	RED	ProServe® Pizza Delivery Bag, Small	Two 16" Pizzas	18" l x 18" w x 5.25" h	15.0 lb	45.7 cm x 45.7 cm x 13.3 cm	6.8 kg	6
FG9F3600	RED	ProServe® Pizza Delivery Bag, Medium	Four 12" or Three 14" Pizzas	18" l x 17.25" w x 7.75" h	15.0 lb	45.7 cm x 43.8 cm x 19.7 cm	6.8 kg	6
FG9F3700	RED	ProServe® Pizza Delivery Bag, Large	Four 16" or Three 18" Pizzas	21.5" l x 19.75" w x 7.75" h	18.0 lb	54.6 cm x 50.2 cm x 19.7 cm	8.2 kg	6
FG9F3800	RED	ProServe® Pizza/Catering/Sandwich Delivery Bag, Medium	Six 12" to 14" Pizzas	17" l x 17" w x 13" h	13.5 lb	43.2 cm x 43.2 cm x 33 cm	6.1 kg	4
FG9F3900	RED	ProServe® Pizza/Catering/Sandwich Delivery Bag, Large	Six 16" Pizzas	19.75" l x 19.75" w x 13" h	15.5 lb	50.2 cm x 50.2 cm x 33 cm	7.0 kg	4
FG9F4000	RED	ProServe® Sandwich Delivery Bag	Fifteen 12" Sub Sandwiches	15" l x 12" w x 12" h	13.5 lb	38.1 cm x 30.5 cm x 30.5 cm	6.1 kg	4

ProServe® Sheet Pan Rack System

Safely transport food from oven to freezer.

- Encourage employee safety with user-friendly handles and protective bumpers
- PanGuard™ locking bar secures pan, and extend base enhances stability to eliminate costly spills
- Easy-to-clean industrial-grade plastic top and bottom and chrome-plated side panels resist rust and corrosion
- Holds 18" x 26" sheet pans at the base, not the edges, for added support
- Heavy-duty thread guard, 5" dia. x 1¼" wide (12.7 cm), features two locking casters
- Vinyl Rack Cover (FG9F9000) reduces cross-contamination when used with ProServe® Rack System
- ProServe® Rack System is NSF-Certified



NO.	COLOR	DESCRIPTION	PAN CAPACITY	U.S. DIMENSIONS	U.S. WEIGHT CAPACITY	U.S. SHIP WT/CTN	METRIC DIMENSIONS	METRIC WEIGHT CAPACITY	METRIC SHIP WT/CTN	CASE PACK
FG9F9700	BLA	ProServe® Standard Base Sheet Pan Rack	26 Slots w/ 2" (5.08 cm) spacing	23" l x 28" w x 69.63" h	300.0 lb	80.0 lb	58.4 cm x 71.1 cm x 178.8 cm	136.1 kg	36.3 kg	1
FG9F9000	CLR	Vinyl Rack Cover for FG9F9700, FG32000 Racks	N/A	23.5" l x 29.5" w x 70.5" h	N/A	5.5 lb	59.7 cm x 74.9 cm x 179.1 cm	N/A	2.5 kg	1



ProServe® Racks and Carts

Increase efficiency by maximizing space, transportation, and storage.

- Versatile system specially designed to work with food pans, food boxes, and sheet pans
- Impact-resistant structural web plastic components stand up to the most demanding kitchens
- Racks and carts are designed with soft, round corners that are easy on the walls, doors, and equipment
- Stylish design and quiet handling moves food easily from kitchen to dining room, minimizing expensive labor costs
- USDA Meat and Poultry Group listed
- NSF-certified for cleanliness
- Casters are 5" (12.7 cm) nonmarking, swivel-plate design (two are lockable)



FG331600



FG332000



FG332400



Convenient disposal hole helps keep work surface clear of debris

FG331600

FG331500 / FG331700

Prep Cart-End Loader

Opening: 13" (33 cm)

Accommodates:



FG331600

Prep Cart-Side Loader

Opening: 26 1/8" (66.4 cm)

Accommodates:

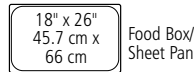

FG332400

Rack-Dual End Loader

Opening: 21 1/8" (53.5 cm)

Accommodates:

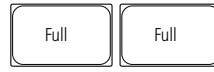

FG332000

Rack-End Loader

Opening: 19 1/8" (50.32 cm)

Accommodates:

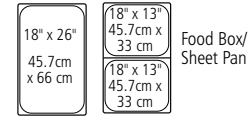

NO.	COLOR	DESCRIPTION	PAN CAPACITY	U.S. DIMENSIONS	U.S. SHIP WT/CTN	METRIC DIMENSIONS	METRIC SHIP WT/CTN	CASE PACK
FG331500 ^a	BLA	ProServe® Prep Cart with Cutting Board (8-slot end loader for full-size insert pans)	8	23.75" l x 18.63" w x 36.13" h	44.8 lb	60.3 cm x 47.3 cm x 91.8 cm	20.3 kg	1
FG331600 ^a	BLA	ProServe® Prep Cart with Cutting Board (8-slot side loader for food boxes and sheet pans)	8	31.75" l x 23.75" w x 36.13" h	52.0 lb	80.6 cm x 60.3 cm x 91.8 cm	23.6 kg	1
FG331700	OWHT	ProServe® Rack (18-slot end loader for full-size insert pans)	18	23.75" l x 18.63" w x 67.88" h	68.4 lb	60.3 cm x 47.3 cm x 172.4 cm	31 kg	1
FG331900	OWHT	ProServe® Rack (18-slot side loader for food boxes and sheet pans)	18	31.75" l x 23.75" w x 67.88" h	72.3 lb	80.6 cm x 60.3 cm x 172.4 cm	32.8 kg	1
FG332000	OWHT	ProServe® Rack (18-slot end loader for food boxes and sheet pans)	18	28.75" l x 23.75" w x 67.88" h	82.0 lb	73 cm x 60.3 cm x 172.4 cm	37.2 kg	1
FG332400	OWHT	ProServe® Rack (18-slot dual loader for full-size insert pans)	18	26.7" l x 28.75" w x 67.88" h	82.0 lb	67.8 cm x 73 cm x 172.4 cm	37.2 kg	1

^aIncludes NSF Food Zone-approved Max System™ Cutting Board

UTILITY REFUSE AND RECYCLING

DECORATIVE REFUSE

CLEANING & SAFETY

MATERIAL HANDLING

WASHROOM

FOODSERVICE

ACCESSORIES & INDEX

Bus/Tote Boxes

Built for long-lasting durability.

- Commercial-grade plastic has reinforced handles, bottom, and ribs for added strength and employee safety
- Rounded corners for easy cleaning
- NSF 3-A and 2-certified
- Commercial dishwasher-safe



FG335100



NO.	COLOR	DESCRIPTION	U.S. CAPACITY	U.S. DIMENSIONS	U.S. SHIP WT/CTN	METRIC CAPACITY	METRIC DIMENSIONS	METRIC SHIP WT/CTN	CASE PACK
FG334900*	WHT GRAY	Bus/Utility Box	4½ gal	20" l x 15" w x 5" h	20.6 lb	17.5 L	50.8 cm x 38.1 cm x 12.7 cm	9.3 kg	12
FG334992*	WHT GRAY	Bus/Utility Box, Bulk Pack	4½ gal	20" l x 15" w x 5" h	444.1 lb	17.5 L	50.8 cm x 38.1 cm x 12.7 cm	201.4 kg	180
FG335000*	BRN	Divided Bus/Utility Box	7 gal	21.5" l x 17.13" w x 7" h	20.6 lb	26.5 L	54.6 cm x 43.5 cm x 17.8 cm	9.3 kg	6
FG335100*	GRAY BRN	Undivided Bus/Utility Box	7½ gal	21.5" l x 17.13" w x 7" h	17.6 lb	28.9 L	54.6 cm x 43.5 cm x 17.8 cm	8 kg	6
FG335192*	GRAY BRN	Undivided Bus/Utility Box, Bulk Pack	7½ gal	21.5" l x 17.13" w x 7" h	335.0 lb	28.9 L	54.6 cm x 43.5 cm x 17.8 cm	152 kg	100
FG369000*	WHT	Food/Tote Box	11 qt	14.38" l x 12.38" w x 5.38" h	6.7 lb	10.4 L	36.5 cm x 31.4 cm x 13.7 cm	3 kg	6
FG364800	GRAY	Lid for FG334900 Bus/Utility Box	N/A	22" l x 16.5" w x 0.75" h	18.0 lb	N/A	55.9 cm x 41.9 cm x 1.9 cm	8.2 kg	12
FG361600*	WHT	Lid for FG369000 Food/Tote Box	N/A	15" l x 12.75" w	2.9 lb	N/A	38.1 cm x 32.4 cm	1.3 kg	6

*Certified to NSF Std. 2 for food contact. *Not NSF-certified.

Cutlery Bin

Safely stores and transports cutlery to minimize employee injuries.

- Made of durable, commercial-grade plastic
- Ribbed design and special resin finish for strength
- Ideal for storing, dispensing, and transporting silverware and condiment packets
- NSF-certified and commercial dishwasher-safe



NO.	COLOR	DESCRIPTION	U.S. DIMENSIONS	U.S. SHIP WT/CTN	METRIC DIMENSIONS	METRIC SHIP WT/CTN	CASE PACK
FG336200	GRAY	Cutlery Bin, 4 Compartments	21.25" l x 11.5" w x 3.75" h	19.1 lb	54 cm x 29.2 cm x 9.5 cm	8.7 kg	12

Bouncer® Pitchers

Designed for safety and lower replacement costs.

- Reduce potential contamination with durable crystal-clear pitchers that resist chipping and breaking
- Drip-proof spout
- Lighter weight for employee safety and less costly than glass
- NSF-certified and commercial dishwasher-safe



FG333400



FG333800

NO.	COLOR	DESCRIPTION	U.S. CAPACITY	U.S. SHIP WT/CTN	METRIC CAPACITY	METRIC SHIP WT/CTN	CASE PACK
FG333100	CLR	Bouncer® II Pitcher	48 oz	6.67 lb	1.4 L	3 kg	6
FG333400	CLR	Bouncer® II Pitcher	60 oz	6.49 lb	1.8 L	2.9 kg	6
FG333500	CLR	Bouncer® Pitcher	48 oz	4.86 lb	1.4 L	2.2 kg	6
FG333600	CLR	Bouncer® Pitcher	32 oz	3.0 lb	0.9 L	1.4 kg	6
FG333700	CLR	Bouncer® Pitcher	54 oz	5.49 lb	1.6 L	2.5 kg	6
FG333800	CLR, GOLD	Bouncer® Pitcher	60 oz	5.72 lb	1.8 L	2.6 kg	6
FG333900	CLR	Bouncer® Pitcher	72 oz	6.63 lb	2.1 L	3 kg	6



Sturdy Chair™ Youth Seats

Sturdy Chair™ Youth Seats make safety and cleanliness a priority for your youngest patrons.

- Contemporary design with Microban® technology makes it easier to clean than wood
- Microban® provides allover protection from bacteria growth that can cause odors and staining; complies with FDA standards
- Meets ASTM 404-08, TUV, and European safety standards
- Stackable design makes for easy storage
- Fits under standard table without tray
- 3-point harness with one-hand release



A new federal standard (ASTM F404-18) has been approved by the Consumer Product Safety Commission to improve the safety of high chairs in the United States. This will go into effect on all high chairs manufactured or imported after June 19, 2019. The Sturdy Chair™ Youth Seat is compliant with all ASTM standards.



*2006 Rubbermaid Study



FG781588PLAT



FG781588DGRN

1819680

FG781588BLA



FG780608PLAT

FG780608BLA

1819679

FG780508DGRN

NO.	COLOR	DESCRIPTION	U.S. DIMENSIONS	U.S. SHIP WT/CTN	METRIC DIMENSIONS	METRIC SHIP WT/CTN	CASE PACK
FG780508	DGRN, PLAT, BLA	Sturdy Chair™ Youth Seat with Wheels	23.5" l x 23.38" w x 29.75" h	18.0 lb	59.7 cm x 59.4 cm x 75.6 cm	8.2 kg	1
FG780608	DGRN, PLAT, BLA	Sturdy Chair™ Youth Seat without Wheels	23.5" l x 23.5" w x 29.75" h	18.0 lb	59.7 cm x 59.7 cm x 75.6 cm	8.2 kg	1
FG781408	DGRN, PLAT, BLA	Sturdy Chair™ Youth Seat, RTA (ready to assemble), No Wheels	23.5" l x 23.5" w x 29.75" h	17.0 lb	59.7 cm x 59.7 cm x 75.6 cm	7.7 kg	1
1819679	Brown	Sturdy Chair™ Youth Seat, RTA (ready to assemble), No Wheels	23.5" l x 23.5" w x 29.75" h	17.0 lb	59.7 cm x 59.7 cm x 75.6 cm	7.7 kg	1
FG781588	DGRN, PLAT, RED, BLA	Tray for FG780508, FG780608, and FG781408 Chairs	11.5" l x 18.5" w x 3.25" h	2.5 lb	29.2 cm x 47 cm x 8.3 cm	1.1 kg	1
1819680	Brown	Tray for FG780508, FG780608, and FG781408 Chairs	11.5" l x 18.5" w x 3.25" h	2.5 lb	29.2 cm x 47 cm x 8.3 cm	1.1 kg	1

MICROBAN® is a registered trademark of Microban Products Company.
©2006 Microban Products Company. All rights reserved. www.microban.com

Microban® protection does not protect user from foodborne illness and is not a substitute for normal cleaning practices.
**Time lapse image.

When ordering products with **BOLD** color codes, please specify color code after the product number. Refer to the Standard Color Guide at the back of the catalog.

UTILITY REFUSE AND RECYCLING

DECORATIVE REFUSE

CLEANING & SAFETY

MATERIAL HANDLING

WASHROOM

FOODSERVICE

ACCESSORIES & INDEX

NEW

HIGH CHAIR REGULATION EFFECTIVE JUNE 19th, 2019

A new federal standard (ASTM F404-18) has been approved by the Consumer Product Safety Commission to improve the safety of high chairs in the United States. This regulation will go into effect on all high chairs manufactured or imported after June 19, 2019.



ALL RCP HIGH CHAIRS ARE COMPLIANT WITH ASTM STANDARDS

ALL HIGH CHAIRS MUST MEET THE CRITERIA BELOW:



ACTIVE THREE-POINT RESTRAINT

An active three-point restraint system is required.



PERMANENT T-BAR RESTRAINT

T-Bar must remain in fixed position at all times.



WARNING LABELS

Warning label must communicate hazards and be clearly visible to consumer.



HIGH CHAIR STABILITY

Must not tip over when pulled forward, backward, or sideways by specified force.



- Microban® antimicrobial protection helps prevent the growth of stain- and-odor causing bacteria
- Microban® protection is built into the chair during the manufacturing process and will not wash or wear off during the life of the chair
- Sturdy Chair™ looks newer longer with built-in Microban® antimicrobial protection

REPRESENTATIVE OF ANTIMICROBIAL EFFECT – 24-HOUR ELAPSED TIME

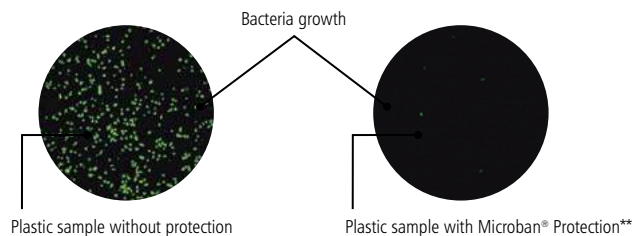

**This information is based upon standard laboratory tests and is provided for comparative purposes to substantiate antimicrobial activity for nonpublic health applications. Microban® technology is not designed to replace good building practices or protect users from disease- causing microorganisms. Antimicrobial action limited to product surfaces.



Common Metric–English Conversions

Measurement	Multiply	By	To get:
Linear	centimeters (cm) inches (in. / ") meters (m) feet (ft. /')	0.3937 2.54 3.2804 0.3048	inches centimeters feet meters
Area	centimeters ² (cm ²) inches ² (in ²) meters ² (m ²) feet ² (ft ²)	0.155 6.4516 10.76391 0.092903	inches ² centimeters ² feet ² meters ²
Volume	centimeters ³ (cm ³) inches ³ milliliters fluid ounces liters gallons	0.06102 16.387 0.033814 29.5735 0.26417 3.78541	inches ³ centimeters ³ fluid ounces milliliters gallons liters
Mass	kilogram (kg) pounds (lbs.) grams (g) ounces (oz.)	2.2046 0.4536 0.035274 28.3495	pounds kilograms ounces grams

Metric Temperature Conversion To Get:	
Degrees Celsius (C°)	$\frac{5 \times (\text{degrees F} - 32)}{9}$
Degrees Fahrenheit (F°)	$\frac{9 \times (\text{degrees C})}{5} + 32$

UTILITY AND
RECYCLING REFUSE



















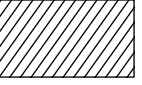



















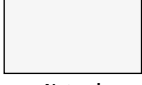
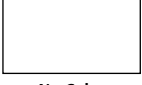



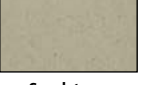

DECORATIVE REFUSE

CLEANING

MATERIAL HANDLING

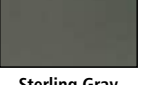
WASHROOM

FOODSERVICE

					
Aged Bronze AGBRNZ	Antique Pewter ATPWTR	Beige BEIG	Black BLA/BK00/38	Blue BLUE/BL00	Bronze BRNZ
					
Brown BRN	Charcoal CHAR	Chrome CHRM	Clear CLR	Cobalt COBLT	Cool Gray CGRAY
					
Cylinder CYLND	Dark Blue DBLUE	Dark Green DGRN	Driftwood DWOOD	Gold GOLD	Gray GRAY/GY00/331
					
Gray Metallic Burl BGRAY	Green GRN/GR00/714	Hammered Silver HSILV	Lacquer LAC	Landmark Steel/ Brown BRN	Landmark Steel/ Brown/Brown BBRN
					
Landmark Steel/ Gray GRAY	Landmark Steel/ Green GRN	Light Gray LGRAY	Light Platinum LPLAT	Mirror Stainless MSSTL	Natural NAT
					
Natural (Foodservice) NAT	No Color 0000	Off-White OWHT	Orange ORAN/OR00/11	Periwinkle PERI	Platinum PLAT/907
					
Red RED/RD00	Sable SBLE	Sandstone SSTON	Satin Stainless SSSTL	Silver SILV	Stainless Steel SSSTL/SSS/SS
					
Stainless Steel/ Black Top SSBLA	Steel STL	Sterling Gray SGRAY	White WHT/WH00	White Granite WGRAN	Yellow YEL/YL00

UTILITY AND
RECYCLING REFUSE

DECORATIVE REFUSE

CLEANING

MATERIAL HANDLING

WASHROOM

FOODSERVICE

PART NO.	Color	DESCRIPTION	PAGE	UPC
401477		AutoFlush® Tempus Valve Adapter	213	
401096		AutoFlush® High Mount Adapter Kit	213	763905010962
401165		AutoFlush® Crane Valve Adapter Kit	213	86876212914
401239		AutoFlush® Teck Valve Adapter Kit	213	86876212921
401972		AutoFlush® Coyne & Delany/ Crane Rex Adapter Kit	213	86876212945
401973		AutoFlush® Canadian Adapter Kit (Crane, Teck, Tempus)	213	86876212952
490071		OneShot® A/C Adapter	193	86876205732
490099		OneShot® 6V Adapter (bayonet)	193	86876213362
490100		OneShot® Adapter Wire (bayonet)	193	86876205763
750577		Lock	207	
1779636	Blue	Lid for 44-Gallon BRUTE® Containers	13	86876209112
1779699	Blue	BRUTE® Container without Lid	12	86876208979
1779700	Blue	Lid for 10-Gallon BRUTE® Container	13	86876208986
1779731	Blue	Lid for 20-Gallon BRUTE® Container	13	86876208993
1779732	Blue	BRUTE® Container without Lid	12	86876209006
1779733	Blue	Lid for 55-Gallon BRUTE® Container	13	86876209013
1779734	Black	Executive BRUTE® Container without Lid	12	86876209020
1779738	Black	Executive Lid for 55-Gallon BRUTE® Container	13	86876209068
1779739	Black	BRUTE® Container without Lid	12	86876209075
1779740	White	BRUTE® Container without Lid	12	86876209082
1779741	Dark Green	BRUTE® Container without Lid	12	86876209099
1779742	Gray	Untouchable® Top for FG295600 Container	39	86876209105
1782742		Milano in Polished Chrome	211	86876210699
1782743		Milano in Polished Chrome (Low Lead)	211	86876210705
1782744		Milano in Polished Chrome (Low Lead)	211	86876210712
1784284		HYGEN™ Microfiber Kit with Charging Bucket	87	86876211092
1788372	Blue	Slim Jim® Mixed Recycling Lid for Slim Jim® Containers	26	
1788373	Green	Slim Jim® Recycling Mixed Lid Green	26	
1788374	Blue	Untouchable® Single-Stream Recycling Top for FG356988 Container	37	86876211566
1788375	Green	Untouchable® Single-Stream Recycling Top for FG356988 Container	37	86876211573
1788380	Blue	BRUTE® 32G Lid — Mixed Recycling	13	86876211627
1788471	Green	BRUTE® 32G Lid — Mixed Recycling	13	86876211634
1788472	Green	BRUTE® Recycling Container without Lid	12	86876211641
1791678	Gray	HYGEN™ General-Purpose Microfiber Mop	84	86876212389
1791679	Green/Blue	HYGEN™ Microfiber Wet and Dust Mop Plus for PULSE™	84	86876212396
1791680	Blue	HYGEN™ Microfiber Mop Plus	84	86876212402
1791796	Blue	HYGEN™ Rough-Surface Scrub Microfiber Mop	84	86876212464
1791802	Yellow	HYGEN™ Charging Bucket with Sieve	82	86876212532
1792339	Blue	Two-Stream Glutton® Recycling Station	41	86876212099
1792340	Green	Two-Stream Glutton® Recycling Station	41	86876212105

PART NO.	Color	DESCRIPTION	PAGE	UPC
1792371	Beige	Two-Stream Glutton® Recycling Station	41	86876212112
1792372	Blue	Four-Stream Glutton® Recycling Station	41	86876212129
1792373	Green	Four-Stream Glutton® Recycling Station	41	86876212136
1792374	Beige	Four-Stream Glutton® Recycling Station	41	86876212143
1792975		Waste Stream Label Kit	41	86876212167
1793506	White	AutoJanitor® LED Dispenser — White	214	86876212662
1793507	Chrome	AutoJanitor® LED Dispenser — Chrome	214	86876212679
1793531	Black	Microburst® 3000 LCD Dispenser — Black	203	86876212716
1793532	White	Microburst® 3000 LCD Dispenser — White	203	86876212723
1793533	Chrome	Microburst® 3000 LCD Dispenser — Chrome	203	86876212730
1793534	Black	Microburst® 9000 LCD Dispenser — Black	204	86876212747
1793535	White	Microburst® 9000 LCD Dispenser — White	204	86876212754
1793536	Chrome	Microburst® 9000 LCD Dispenser — Chrome	204	86876212761
1793541	White	Standard Aerosol LCD Dispenser — White	206	86876212815
1793544	White	TCell™ Fan Dispenser — White	207	86876212846
1793546	Black	TCell™ Dispenser — Black	207	86876212860
1793547	White	TCell™ Dispenser — White	207	86876212877
1793548	Chrome	TCell™ Dispenser — Chrome	207	86876212884
1805727	Red	Sanitizer-Safe Microfiber Cloth — Red	87	86876213522
1805728	Blue	Sanitizer-Safe Microfiber Cloth — Blue	87	86876213539
1805730	Green	Sanitizer-Safe Microfiber Cloth — Green	87	86876213553
1809375		Self-Wringing Twist Mop	117	41301001761
1812588		Compact Digital Portion Control Scale (2 lb)	234	86876214130
1812589		Compact Digital Portion Control Scale (10 lb)	234	86876214147
1812590		High-Performance Digital Portion Control Scale (2 lb)	234	86876214154
1812591		High-Performance Digital Portion Control Scale (12 lb)	234	86876214161
1812592		High-Performance Digital Portion Control Scale (24 lb)	234	86876214178
1812595		Premium Stainless Steel Dishwasher-Safe Digital Portion Control Scale (12 lb)	234	86876214208
1818966		Milano in Polished Chrome	271	86876219197
1818967		Milano in Polished Chrome	271	86876219203
1818968		Milano in Polished Chrome	271	86876219210
1819679		Sturdy Chair™ Youth Seat, RTA (ready to assemble), No Wheels	242	
1819680		Tray for FG780508, FG780608, and FG781408 Chai	242	
1820577	Pink	12" x 12" Microfiber Light Commercial Cloth	88	86876215182
1820578	Green	12" x 12" Microfiber Light Commercial Cloth	88	86876215199
1820579	Blue	12" x 12" Microfiber Light Commercial Cloth	88	86876215205
1820580	Yellow	12" x 12" Microfiber Light Commercial Cloth	88	86876215212
1820581	Pink	16" x 16" Microfiber Light Commercial Cloth	88	86876215229
1820582	Green	16" x 16" Microfiber Light Commercial Cloth	88	86876215236
1820583	Blue	16" x 16" Microfiber Light Commercial Cloth	88	86876215243

PART NO.	Color	DESCRIPTION	PAGE	UPC
1820584	Yellow	16" x 16" Microfiber Light Commercial Cloth	88	86876215250
1822351	White	HYGEN™ Disposable Microfiber Cloth Charging Tub	75	86876221138
1822352	White	HYGEN™ Disposable Microfiber Mop Pad	75	86876218398
1824723	Red/Blue/ Yellow/Green	Sanitizer-Safe Microfiber Cloth – 4-Pack	87	86876216318
1829398	Blue	BRUTE® Dome Top for 32-Gallon BRUTE® Container	13	86876215922
1829400	Green	Slim Jim® Swing Lid for Slim Jim® Containers	26	
1829407	Blue	Untouchable® Swing Top for FG295700 Container	39	86876216028
1829409	Gray	Untouchable® Swing Top for FG295700 Container	39	86876216042
1829410	White	BRUTE® Rollout Container with Lid	17	86876216059
1829411	Green	BRUTE® Rollout Container with Lid	17	86876216066
1834781	Red	Round Bucket – Sanitizer	116	86876216455
1834840	Blue	BRUTE® Dome Top for 44-Gallon BRUTE® Container	13	86876216424
1835528	Yellow	HYGEN™ PULSE™ Mopping Kit with Single-Sided Frame	82	86876192339
1835529	Yellow	HYGEN™ PULSE™ Mopping Kit with Double-Sided Folding Frame	84	86876212372
1837785	Black	Executive Housekeeping Cart Waste/Bag Lid – Traditional	144	86876217186
1837941		Key	207	
1840999	Orange	Insulated Beverage Dispenser	305	79154116219
1842436	Clear	Cold Pan	231	86876218282
1842437	Clear	Cold Pan	231	86876218299
1853755	Chrome	Foam Skin Care Dispenser 800 mL — Chrome	198	86876227277
1857374	Yellow	5-Quart Pail – Yellow	140	86876219432
1857375	Red	5-Quart Pail – Red	140	86876219449
1857376	Blue	5-Quart Pail – Blue	140	86876219456
1857377	Green	5-Quart Pail – Green	140	86876219463
1857378	Black	Executive 5-Quart Heavy-Duty Pail – Black	140	86876219470
1861076	Black	Executive Angle Broom w/ Vinyl Handle	129	86876220650
1861078	Black	Executive Angle Broom w/ Aluminum Handle	129	86876220667
1861427	Black	Executive Janitorial Cleaning Cart, High-Security	179	86876221251
1861427	Black	Executive Janitorial Cleaning Cart – High-Security	138	86876221251
1861430	Black	Executive Janitorial Cleaning Cart – Traditional	139	86876221282
1861443	Black	Executive Janitorial Cleaning Cart Locking Door Kit – Traditional	139	86876221312
1861443	Black	Executive Janitorial Cleaning Cart Locking Door Kit – Traditional, Black	140	86876221312
1863882	Silver	Executive HYGEN™ 42" to 72" (121.9 cm– 182.9 cm) Microfiber Telescoping Handle	81	86876220483
1863883	Silver	Executive HYGEN™ 20" to 40" (50.8 cm– 101.6 cm) Microfiber Telescoping Handle	81	86876220490
1863884	Silver	Executive HYGEN™ PULSE™ Microfiber Spray Mop, Single-Sided Flat Mop	83	86876220506
1863885	Silver	Executive HYGEN™ PULSE™ Microfiber Spray Mop, Double-Sided Flat Mop	85	86876220513
1863888	Gray	Executive 12" Multipurpose Microfiber Cloth	88	86876220544
1863889	Gray	Executive 16" Multipurpose Microfiber Towel	88	86876220551

PART NO.	Color	DESCRIPTION	PAGE	UPC
1863892	Gray	Executive HYGEN™ Microfiber Charging Mop Bucket	82	86876220582
1863893	Black	Executive 17" (43.2 cm) HYGEN™ Quick-Connect Wet/Dry Frame	80	86876220599
1863894	Black	Executive 18" HYGEN™ PULSE™ Microfiber Flat Mop Frame, Double-Sided	85	86876220605
1863895	Gray	Executive Series™ HYGEN™ 18" Microfiber Wet Pad	79	86876220612
1863896	Black	35 qt WaveBrake® Side-Press Bucket and Wringer, Executive Series™	95	86876221152
1863898	Black	Executive WaveBrake® Down-Press Combo	137	86876221176
1863901	Black	Executive 60" Fiberglass Mop Handle and Gripper® Clamp Frame – String Mop	115	86876221220
1863903	Black	Executive 60" Fiberglass Mop Handle and Invader® Side-Gate Frame – String Mop	115	86876221213
1867396	Black	Executive 1" HYGEN™ Microfiber Flexible Flat Mop Frame, Single-Sided	77	86876220629
1867397	Gray	Executive HYGEN™ Multipurpose Microfiber PULSE™ Dust Flat Mop, Single-Sided	78	86876220636
1867398	Gray	Executive 16" HYGEN™ Glass Microfiber Cloth (Gray)	76	86876220643
1867505	Black	Executive Multilingual Caution Sign, 2-Sided, Black	155	86876222180
1867506	Gray	Executive Multilingual Caution Sign, 2-Sided, Gray	155	86876222197
1867507	Gold	Executive Wooden Multilingual Caution Sign, 2-Sided, Gold	155	86876222203
1867508	Silver	Executive Wooden Multilingual Caution Sign, 2-Sided, Silver	155	86876222210
1867509	Black	Executive Multilingual Caution Sign, 4-Sided, Black	155	86876222227
1867531	Black	Executive BRUTE® Container without Lid	12	86876222241
1867531	Black	Executive BRUTE® 32-Gallon Container	141	86876222241
1867532	Black	Executive Lid for 32-Gallon BRUTE® Container	13	86876222258
1867533	Black	Executive BRUTE® Caddy Bag for 32- and 44-Gallon BRUTE® Containers	15	86876222265
1867537	Black	Executive Cube Truck w/ Quiet Casters	168	86876222296
1867538	Black	Executive Cube Truck w/ Quiet Casters	168	86876222302
1868991	Black	Executive Cart Waste/Bag Lid – High-Capacity	141	7892279089915
1878365		Executive 6" Quiet Caster Wheel Kit, Housekeeping Carts	141	86876221374
1878367	Dark Gray	Executive Quiet Caster and Ball-Bearing Wheel Kit	141	86876221343
1878368		Vacuum Bungees for Carts	140	86876221350
1880994	Black	Executive Divided Carry Caddy	144	86876222166
1880994	Black	Executive Divided Carry Caddy	149	86876222166
1880995	Gray	Executive Divided Carry Caddy	144	86876222173
1880995	Gray	Executive Divided Carry Caddy	149	86876222173
1881749	Black	Collapsible X-Cart, 4 Bushels	169	86876221626
1881750	Black	Collapsible X-Cart, 8 Bushels	169	86876221633
1881781	Black	Collapsible Multi-Stream X-Cart (2 x 4 Bushels)	169	86876221640

UTILITY AND RECYCLING REFUSE

DECORATIVE REFUSE

CLEANING

MATERIAL HANDLING

WASHROOM

FOODSERVICE

ACCESSORIES & INDEX



PART NO.	Color	DESCRIPTION	PAGE	UPC
1881782	Black	Collapsible X-Cart Replacement Bag – 4 Bushels	169	86876221657
1881783	Black	Collapsible X-Cart Replacement Bag – 8 Bushels	169	86876221664
1883455	Beige	Resin Front Step	35	86876223897
1883456	Beige	Resin Front Step	35	86876223903
1883457	Beige	Resin End Step	35	86876223910
1883458	Beige	Resin Front Step	35	86876223927
1883459	Beige	Resin End Step	35	86876223934
1883460	Beige	Resin Front Step	35	86876223941
1883551	Beige	Resin End Step	35	86876223958
1883552	Beige	Resin Front Step	35	86876223965
1883553	Beige	Resin End Step	35	86876223972
1883554	White	Resin Front Step	35	86876223989
1883555	White	Resin Front Step	35	86876223996
1883557	White	Resin Front Step	35	86876224016
1883559	White	Resin Front Step	35	86876224030
1883561	White	Resin Front Step	35	86876224054
1883563	Red	Resin Front Step	35	86876224078
1883564	Red	Resin Front Step	35	86876224085
1883565	Red	Resin End Step	35	86876224092
1883566	Red	Resin Front Step	35	86876224108
1883568	Red	Resin Front Step	35	86876224122
1883570	Red	Resin Front Step	35	86876224146
1883593	Blue	Resin Front Step	35	86876224375
1883597	Blue	Resin Front Step	35	86876224412
1883599	Gray	Resin Front Step	35	86876224436
1883600	Gray	Resin Front Step	35	86876224443
1883602	Gray	Resin Front Step	35	86876224467
1883604	Gray	Resin Front Step	35	86876224481
1883606	Gray	Resin Front Step	35	86876224504
1883608	Black	Resin Front Step	35	86876224528
1883609	Black	Resin Front Step	35	86876224535
1883610	Black	Resin End Step	35	86876224542
1883611	Black	Resin Front Step	35	86876224559
1883612	Black	Resin End Step	35	86876224566
1883613	Black	Resin Front Step	35	86876224573
1883614	Black	Resin End Step	35	86876224580
1883615	Black	Resin Front Step	35	86876224597
1883616	Black	Resin End Step	35	86876224603
1883617		Slim Jim® Rigid Liner for 50L/13G Resin FS	36	86876224856
1883618		Slim Jim® Rigid Liner for 30L/8G Resin FS	36	86876224863
1883619		Slim Jim® Rigid Liner for 50L/13G Resin FS	36	86876224870
1883620		Slim Jim® Rigid Liner for 68L/18G Resin FS	36	86876224887
1883621		Slim Jim® Rigid Liner for 90L/24G Resin FS	36	86876224894
1883623		Slim Jim® Rigid Liner for 30L/8G Resin ES	36	86876224900
1883624		Slim Jim® Rigid Liner for 50L/13G Resin ES	36	86876224917
1883625		Slim Jim® Rigid Liner for 68L/18G Resin ES	36	86876224924
1883626		Slim Jim® Rigid Liner for 90L/24G Resin ES	36	86876224931
1883629		Dual Liner for Slim Jim® 90L/24G Resin FS	36	86876224962
1889863	Black	Collapsible X-Cart Cover, Small (for 1881749)	169	86876223019
1889864	Black	Collapsible X-Cart Cover, Large (for 1881750 and 1881781)	169	86876223026
1892265		AutoFoam Drip Tray	195	
1900666		For 15L/4G Stainless Steel FS	59	86876225105
1900669		Rigid Liner Set For Slim Jim® 15L/4G Stainless Steel FS	59	86876225037
1900680		Rigid Liner Set For Slim Jim® 30L/8G Stainless Steel ES	59	86876225051

PART NO.	Color	DESCRIPTION	PAGE	UPC
1900696		Rigid Liner Set For 30L/8G Stainless Steel FS	59	86876225129
1900697		Rigid Liner Set For Slim Jim® 30L/8G Stainless Steel FS	59	86876225044
1900713		Rigid Liner Set For 50L/13G Stainless Steel FS	59	86876225136
1900715		Rigid Liner Set For Slim Jim® 50L/13G Stainless Steel FS	59	86876225068
1900733		Rigid Liner For 90L/24G Stainless Steel FS	59	86876226454
1900734		For Slim Jim® 90L/24G Stainless Steel FS	59	86876225082
1900895		For 50L/13G Stainless Steel ES	59	86876225143
1900896		For Slim Jim® 50L/13G Stainless Steel ES	59	86876225075
1900912		For 90L/24G Stainless Steel ES	59	86876225150
1900913		Rigid Liner For Slim Jim® 90L/24G Stainless Steel ES	59	86876225099
1901982	Stainless Steel	Stainless Steel Front Step	55	86876224610
1901985	Stainless Steel	Stainless Steel Front Step	55	86876224627
1901987	Stainless Steel	Stainless Steel Front Step with Dual Liner	55	86876224634
1901992	Stainless Steel	Stainless Steel Front Step	55	86876224658
1901993	Stainless Steel	Stainless Steel End Step	55	86876224672
1901994	Stainless Steel	Stainless Steel Front Step with Dual Liner	55	86876224665
1901999	Stainless Steel	Stainless Steel Front Step	55	86876224689
1902000	Stainless Steel	Stainless Steel End Step	55	86876224702
1902001	Stainless Steel	Stainless Steel Front Step with Dual Liner	55	86876224696
1902006		Dual Liner Sets For Slim Jim® 30L/8G Stainless Steel FS	59	86876224979
1902008		Dual Liner Sets For Slim Jim® 50L/13G Stainless Steel FS	59	86876224986
1902010		For Slim Jim® 90L/24G Stainless Steel FS	59	86876224993
1902459	Dark Gray	Executive Quick Cart Caddy – Small	146	86876223712
1902465	Dark Gray	Executive Quick Cart – Large	146	86876223583
1902466	Dark Gray	Executive Quick Cart – Medium	146	86876223590
1902467	Dark Gray	Executive Quick Cart – Small	146	86876223606
1902468	Dark Gray	Executive Quick Cart Caddy – Large	146	86876223705
1902701	Black	Executive Quick Cart Liner – Large	146	86876223767
1902702	Black	Executive Quick Cart Liner – Medium	146	86876223774
1902703	Black	Executive Quick Cart Liner – Small	146	86876223781
1903281		Verona in Polished Chrome	211	86876222845
1903286		Milano in Polished Chrome	211	86876222722
1903287		Milano in Polished Chrome	211	86876222739
1903288		Milano in Polished Chrome	211	86876222746
1903289		Milano in Polished Chrome	211	86876222753
1903290		Milano in Polished Chrome	211	86876222760
1903291		Milano in Polished Chrome	211	86876222777
1919270	Clear	Executive Quick Cart Plastic Pocket Liner	146	86876223798
1924782	Blue	Maximizer™ Blend Mop	102	
1924783	Blue	Maximizer™ Blend Mop	102	
1924786	Red	Maximizer™ Blend Mop	102	
1924787	Red	Maximizer™ Blend Mop	102	
1924812	Blue	Maximizer™ Microfiber Mop	102	86876225679
1924813	Blue	Maximizer™ Microfiber Mop	102	86876225686
1924814	Green	Maximizer™ Microfiber Mop	102	86876225693
1924815	Green	Maximizer™ Microfiber Mop	102	86876225709
1924816	Red	Maximizer™ Microfiber Mop	102	86876225716
1924817	Red	Maximizer™ Microfiber Mop	102	86876225723
1925447		Damper Replacement for 30L/8G, 50L/13G, 68L/18G, & 90L/24G Resin FS	36	86876225372

PART NO.	Color	DESCRIPTION	PAGE	UPC
1925497		Damper Replacement for 30L/8G & 50L/13G ES Resin	36	86876225358
1925498		Damper Replacement for 68L/18G & 90 L/24G ES Resin	36	86876225365
1926826	Black	Lid for 10-Gallon BRUTE® Container	13	86876225389
1926827	Black	BRUTE® Container without Lid	12	86876225396
1926828	Dark Green	BRUTE® Recycling Container without Lid	12	86876225402
1926829	Dark Green	BRUTE® Recycling Container without Lid	12	86876225419
1928023	White	HYGEN™ Disposable Microfiber Cloth Refill Pack	75	86876225747
1928024	White	HYGEN™ Disposable Microfiber Cloth Bulk Pack	75	86876225754
1928756	White	HYGEN™ Disposable Microfiber Cloth Starter Kit	75	86876225730
1937648	Grey	Premier Small-Capacity Storage w/ Lid	291	71691491514
1937691	Grey	Premier Small-Capacity Storage w/ Lid	291	71691490999
1937692	Grey	Premier Small-Capacity Storage w/ Lid	291	71691490968
1937693	Grey	Premier Small-Capacity Storage w/ Lid	291	71691490975
1938171	Polished Chrome	OneShot® Foam Dispenser Low Profile	193	
1951293	Grey	Premier Small-Capacity Storage w/ Lid	291	71691494928
1955228	Black	Microburst® 3000 Dispenser with LumeCel™ Technology — Black	202	86876227062
1955229	White	Microburst® 3000 Dispenser with LumeCel™ Technology — White	202	86876227079
1955230	Chrome	Microburst® 3000 Dispenser with LumeCel™ Technology — Chrome	202	86876227086
1955959	Black	Slim Jim® Container with Venting Channels	22	86876227840
1955960	Green	Slim Jim® Container with Venting Channels	22	86876227857
1956181	Brown	Slim Jim® Container with Venting Channels	22	86876227864
1956185	Blue	Slim Jim® Container with Venting Channels	22	86876227956
1956186	Green	Slim Jim® Container with Venting Channels	22	86876227925
1956187	Brown	Slim Jim® Container with Venting Channels	22	86876227932
1956188	Yellow	Slim Jim® Container with Venting Channels	22	86876227963
1956189	Red	Slim Jim® Container with Venting Channels	22	86876227949
1956191	Stainless	Slim Jim® Stainless Steel Dolly for Slim Jim® Containers – Double	23	86876227987
1956191	Stainless	Slim Jim® Stainless Steel Dolly for Slim Jim® Containers – Double	33	86876227987
1956192	Stainless	Slim Jim® Stainless Steel Dolly for Slim Jim® Containers – Triple	23	86876227994
1956192	Stainless	Slim Jim® Stainless Steel Dolly for Slim Jim® Containers – Triple	33	86876227994
1956193	Stainless	Slim Jim® Stainless Steel Dolly for Slim Jim® Containers – Quadruple	23	86876228007
1956193	Stainless	Slim Jim® Stainless Steel Dolly for Slim Jim® Containers – Quadruple	33	86876228007
1957521		TCell™ 2.0 Refill — Spring Blossoms	265	86876227741
1957522		TCell™ 2.0 Refill — Citrus Zest	265	86876227734

PART NO.	Color	DESCRIPTION	PAGE	UPC
1957523		TCell™ 2.0 Refill — Mango Blast	265	86876227758
1957524		TCell™ 2.0 Refill — Cucumber Melon	265	86876227765
1957525		TCell™ 2.0 Refill — Marine Fresh	265	86876227772
1957526		TCell™ 2.0 Refill — Lavender Mint	265	86876227789
1957527		TCell™ 2.0 Refill — Opulence	265	86876227796
1957528		TCell™ 2.0 Refill — Decadence	265	86876227802
1957529		TCell™ 2.0 Refill — Elegance	265	86876227819
1957531	Black	TCell™ 2.0 Dispenser — Black	265	86876227673
1957531	Black	TCell™ 2.0 Dispenser — Black	265	86876227673
1957532	White	TCell™ 2.0 Dispenser — White	265	86876227680
1957532	White	TCell™ 2.0 Dispenser — White	265	86876227680
1957533	Chrome	TCell™ 2.0 Dispenser — Chrome	265	86876227697
1957533	Chrome	TCell™ 2.0 Dispenser — Chrome	265	86876227697
1961505	Grey Stenni Gloss	33G with Cans Label	48	86876228670
1961506	Grey Stenni Gloss	33G with Organic Label	48	86876228687
1961507	Grey Stenni Gloss	45G with Landfill Label	48	86876228694
1961508	Grey Stenni Gloss	45G with Mixed Label	48	86876228700
1961509	Grey Stenni Gloss	45G with Paper Label	48	86876228717
1961510	Grey Stenni Gloss	45G with Plastic Label	48	86876228724
1961572	Black	Landfill Black Sign	49	
1961573	Black	Landfill Black Sign	49	
1961574	Black	Landfill Black Sign	49	
1961575	Black	Landfill Black Sign	49	
1961576	Orange	Glass Orange Sign	49	
1961577	Orange	Glass Orange Sign	49	
1961578	Orange	Glass Orange Sign	49	
1961579	Orange	Glass Orange Sign	49	
1961580	Green	Organic Waste Green Sign	49	
1961581	Green	Organic Waste Green Sign	49	
1961582	Green	Organic Waste Green Sign	49	
1961583	Green	Organic Waste Green Sign	49	
1961584	Red	Plastic Red Sign	49	
1961585	Red	Plastic Red Sign	49	
1961586	Red	Plastic Red Sign	49	
1961587	Red	Plastic Red Sign	49	
1961588	Blue	Mixed Recycling Blue Sign	49	
1961589	Blue	Paper Blue Sign	49	
1961590	Blue	Mixed Recycling Blue Sign	49	
1961591	Blue	Paper Blue Sign	49	
1961592	Blue	Mixed Recycling Blue Sign	49	
1961593	Blue	Paper Blue Sign	49	
1961594	Blue	Mixed Recycling Blue Sign	49	
1961595	Blue	Paper Blue Sign	49	
1961596	Yellow	Cans Yellow Sign	49	
1961597	Yellow	Cans Yellow Sign	49	
1961598	Yellow	Cans Yellow Sign	49	
1961599	Yellow	Cans Yellow Sign	49	
1961614	Grey Stenni Gloss	15G with Landfill Label	48	86876228489
1961615	Grey Stenni Gloss	15G with Mixed Label	48	86876228496
1961616	Grey Stenni Gloss	15G with Paper Label	48	86876228502
1961617	Grey Stenni Gloss	15G with Plastic Label	48	86876228519
1961618	Grey Stenni Gloss	15G with Glass Label	48	86876228526

UTILITY AND RECYCLING REFUSE

DECORATIVE REFUSE

CLEANING

MATERIAL HANDLING

WASHROOM

FOODSERVICE

ACCESSORIES & INDEX



UTILITY AND
RECYCLING REFUSE

DECORATIVE REFUSE

CLEANING

MATERIAL HANDLING

WASHROOM

FOODSERVICE

ACCESSORIES
& INDEX

PART NO.	Color	DESCRIPTION	PAGE	UPC
1961619	Grey Stenni Gloss	15G with Cans Label	48	86876228533
1961620	Grey Stenni Gloss	15G with Organic Label	48	86876228540
1961621	Grey Stenni Gloss	23G with Landfill Label	48	86876228557
1961622	Grey Stenni Gloss	23G with Mixed Label	48	86876228564
1961623	Grey Stenni Gloss	23G with Paper Label	48	86876228571
1961624	Grey Stenni Gloss	23G with Plastic Label	48	86876228588
1961625	Grey Stenni Gloss	23G with Glass Label	48	86876228595
1961626	Grey Stenni Gloss	23G with Cans Label	48	86876228601
1961627	Grey Stenni Gloss	23G with Organic Label	48	86876228681
1961628	Grey Stenni Gloss	33G with Landfill Label	48	86876228625
1961629	Grey Stenni Gloss	33G with Mixed Label	48	86876228632
1961630	Grey Stenni Gloss	33G with Paper Label	48	86876228649
1961641	Grey Stenni Gloss	33G with Plastic Label	48	86876228656
1961642	Grey Stenni Gloss	33G with Glass Label	48	86876228663
1961681	Grey Stenni Gloss	45G with Glass Label	48	86876228731
1961682	Grey Stenni Gloss	45G with Cans Label	48	86876228748
1961683	Grey Stenni Gloss	45G with Organic Label	48	86876228755
1966719	Yellow	24-Gal. Janitorial Cleaning Cart Vinyl Bag – Traditional	139	86876227338
1966720	Black	Executive 24-Gal. Janitorial Cleaning Cart Vinyl Bag – Traditional	139	86876227345
1966881	Yellow	34-Gal. Janitorial Cleaning Cart Vinyl Bag – High-Capacity	184	86876227352
1966881	Yellow	34-Gal. Janitorial Cleaning Cart Vinyl Bag – High Capacity	140	86876227352
1966882	Red	34-Gal. Janitorial Cleaning Cart Vinyl Bag – High-Capacity	184	86876227369
1966882	Red	34-Gal. Janitorial Cleaning Cart Vinyl Bag – High-Capacity	140	86876227369
1966883	Blue	34-Gal. Janitorial Cleaning Cart Vinyl Bag – High-Capacity	184	86876227376
1966883	Blue	34-Gal. Janitorial Cleaning Cart Vinyl Bag – High-Capacity	140	86876227376
1966884	Green	34-Gal. Janitorial Cleaning Cart Vinyl Bag – High-Capacity	184	86876227383
1966884	Green	34-Gal. Janitorial Cleaning Cart Vinyl Bag – High-Capacity	140	86876227383
1966885	Brown	34-Gal. Janitorial Cleaning Cart Vinyl Bag – High-Capacity	140	86876227390
1966886	Black	Executive 34-Gal. Janitorial Cleaning Cart Vinyl Bag – High-Capacity	144	86876227406
1966886	Black	Executive 34-Gal. Janitorial Cleaning Cart Vinyl Bag – High-Capacity	142	86876227406
1966886	Black	Executive 34-Gal. Janitorial Cleaning Cart Vinyl Bag – High-Capacity	179	86876227406
1966887	Brown	30-Gal. Housekeeping Cart Canvas Vinyl-Lined Bag – High-Capacity	144	86876227413
1966888	Black	Executive 30-Gal. Housekeeping Cart Canvas Vinyl Lined Bag - High Capacity	184	86876227420

PART NO.	Color	DESCRIPTION	PAGE	UPC
1966888	Black	Executive 30-Gal. Housekeeping Cart Canvas Vinyl-Lined Bag – High-Capacity	144	86876227420
1966888	Black	Executive 30-Gal. Housekeeping Cart Canvas Vinyl-Lined Bag – High Capacity	142	86876227420
1966889	Black	Executive Side-Load Mesh Linen Bag	142	86876227437
1966889	Black	Executive Side-Load Mesh Linen Bag	144	86876227437
1967263		TCell™ 2.0 Refill — Pure	265	86876227826
1968468	Stainless	Slim Jim® Stainless Steel Dolly for Slim Jim® Containers – Single	23	86876227970
1969596	Platinum	Executive Full-Size Housekeeping Cart – Traditional	142	86876227574
1971257	Blue	Slim Jim® Container with Venting Channels	22	86876227901
1971258	Gray	Slim Jim® Container with Venting Channels	22	86876227895
1971259	Beige	Slim Jim® Container with Venting Channels	22	86876227918
1971941	Gray	BRUTE® Rollout	17	
1971943	Blue	BRUTE® Rollout	17	
1971944	Gray	BRUTE® Step-On Rollout	17	
1971946	Blue	BRUTE® Step-On Rollout	17	
1971956	Gray	BRUTE® Step-On Rollout	17	
1971958	Blue	BRUTE® Step-On Rollout	17	
1971968	Gray	BRUTE® Step-On Rollout	17	
1971970	Blue	BRUTE® Step-On Rollout	17	
1971991	Gray	BRUTE® Step-On Rollout	17	
1971993	Blue	BRUTE® Step-On Rollout	17	
1971947	Gray	BRUTE® Rollout With Casters	18	
1971949	Blue	BRUTE® Rollout With Casters	18	
1971959	Gray	BRUTE® Rollout With Casters	18	
1971961	Blue	BRUTE® Rollout With Casters	18	
1971971	Gray	BRUTE® Rollout With Casters	18	
1971973	Blue	BRUTE® Rollout With Casters	18	
1971994	Gray	BRUTE® Rollout With Casters	18	
1971996	Blue	BRUTE® Rollout With Casters	18	
1972664	Brushed Chrome	TCell™ 2.0 Dispenser — Brushed Chrome	265	86876227703
1972664	Brushed Chrome	TCell™ 2.0 Dispenser — Brushed Chrome	265	86876227703
1971977	Red	BRUTE® Medical Waste Rollout With Casters	19	
1972000	Red	BRUTE® Medical Waste Rollout With Casters	19	
1975229		Executive 8" Quiet Caster – Swivel Fixed Pack 2	144	86876230215
1975230		Executive 8" Quiet Caster – Fixed Pack 2	144	86876230222
1977785		Waste Stream Label Kit Version A fits 20-Gallon BRUTE® Containers, 23- and 35-Gallon Untouchable® Containers, and Medium and Large Wastebaskets	45	
1977787		Recycling Label Kit Version C fits 32- and 44-Gallon BRUTE® Containers	45	
1977788		Waste Stream Label Kit Version D fits 50-Gallon BRUTE® Rollout Containers and 1/2- and 1-Cubic-Yard Tilt Trucks	45	
1977789		Recycling Label Kit Version E fits 16- and 23-Gallon Slim Jim® Containers	45	
1977789		Waste Stream Label Kit Version E fits 16- and 23-Gallon Slim Jim® Containers	45	

PART NO.	Color	DESCRIPTION	PAGE	UPC
1978082	Clear	Economy Pitcher	305	71691501411
1980200	Red	Color-Coded Square Container Lid	228	86876231991
1980257	Purple	Color-Coded Round Container Lid	229	86876232363
1980260	Red	Color-Coded Round Container Lid	229	86876232394
1980301	Green	Color-Coded Square Container Lid	228	86876232004
1980302	Blue	Color-Coded Square Container Lid	228	86876232011
1980303	Yellow	Color-Coded Square Container Lid	228	86876232028
1980304	Purple	Color-Coded Square Container Lid	228	86876232035
1980307	Red	Color-Coded Square Container Lid	228	86876232059
1980308	Green	Color-Coded Square Container Lid	228	86876232066
1980309	Blue	Color-Coded Square Container Lid	228	86876232073
1980310	Yellow	Color-Coded Square Container Lid	228	86876232080
1980311	Purple	Color-Coded Square Container Lid	228	86876232097
1980337	Red	Color-Coded Round Container Lid	229	86876232332
1980338	Green	Color-Coded Round Container Lid	229	86876232349
1980339	Blue	Color-Coded Round Container Lid	229	86876232356
1980381	Green	Color-Coded Round Container Lid	229	86876232400
1980382	Blue	Color-Coded Round Container Lid	229	86876232417
1980384	Purple	Color-Coded Round Container Lid	229	86876232424
1980387	Red	Color-Coded Round Container Lid	229	86876232455
1980388	Green	Color-Coded Round Container Lid	229	86876232462
1980389	Blue	Color-Coded Round Container Lid	229	86876232479
1980391	Purple	Color-Coded Round Container Lid	229	86876232486
1980417	Green	Color Coded High-Heat Spatula	295	86876231861
1980418	Blue	Color Coded High-Heat Spatula	232	86876231878
1980419	Yellow	Color Coded High-Heat Spatula	232	86876231885
1980420	Purple	Color Coded High-Heat Spatula	232	86876231892
1980602	Black	Slim Jim® Resin Trainable Dolly for Slim Jim® Containers	23	
1980826	Black/Chrome	AutoFoam Dispenser with LumeCel™ Technology	191	
1980827	Black/Grey Pearl	AutoFoam Dispenser with LumeCel™ Technology	191	
1980828	White/Grey Pearl	AutoFoam Dispenser with LumeCel™ Technology	191	
1980829	Black/Black Pearl	AutoFoam Dispenser with LumeCel™ Technology	191	
1980831	White/Black Pearl	AutoFoam Dispenser with LumeCel™ Technology	191	
1981140	Green	Color-Coded High-Heat Spatula	232	86876231809
1981141	Blue	Color-Coded High-Heat Spatula	232	86876231816
1981142	Yellow	Color-Coded High-Heat Spatula	232	86876231823
1981143	Purple	Color-Coded High-Heat Spatula	232	86876231830
1982721	Brown Stone	Safti-Grip® Bath Mat, Medium	217	86876180084

PART NO.	Color	DESCRIPTION	PAGE	UPC
1982724	White	Safti-Grip® Bath Mat, Medium	217	86876161731
1982725	Brown Stone	Safti-Grip® Bath Mat, Large	217	86876180091
1982726	White	Safti-Grip® Bath Mat, Large	217	86876159363
1982728	Brown Stone	Safti-Grip® Bath Mat, XLarge	217	86876180114
1982729	White	Safti-Grip® Bath Mat, XLarge	217	86876180107
1982727	White	Safti-Grip® Shower Mat	217	86876180121
1987863		Landfill Label	56	
1987865		Trash Label	56	
1987867		Paper Label	56	
1987869		Mixed Recycling Label	56	
1988001		Cans Label	56	
1988003		Plastic Label	56	
1988005		Bottles/Cans Label	56	
1988007		Glass Label	56	
1988009		Organic Waste Label	56	
1988011		Compost Label	56	
1988013		Landfill Label	56	
1988015		Trash Label	56	
1988017		Paper Label	56	
1988019		Mixed Recycling Label	56	
1988021		Cans Label	56	
1988023		Plastic Label	56	
1988025		Bottles/Cans Label	56	
1988027		Glass Label	56	
1988029		Organic Waste Label	56	
1988031		Compost Label	56	
1997206	Black	Small Heavy Duty Adaptable Cart	171	
1997207	Gray	Small Heavy Duty Adaptable Cart	171	
1997208	Black	Medium Heavy Duty Adaptable Cart	171	
1997209	Gray	Medium Heavy Duty Adaptable Cart	171	
1997227	Red	Pack Of 4 Accessory Hooks	171	
1997230	Red	Medium Extended Base	171	
1997371	Black	5" Replacement Caster Set (Locking)	171	
1997410	Red	BRUTE® Construction And Landscape Dolly	14	
1997801	Red	BRUTE® Multi-Surface Dolly	14	
1997803	Black	BRUTE® Anchor Kit – Concrete	14	
1997802	Black	BRUTE® Anchor Kit – Dirt/Grass/Sand	14	
2007192	Red	Closed Lid Insert	31	
2007193	Red	Bottles/Cans Lid Insert	31	
2007194	Red	Paper Slot Lid Insert	31	
2007195	Red	Mixed Recycling Lid Insert	31	
2007200	Yellow	Closed Lid Insert	31	
2007881	Yellow	Bottles/Cans Lid Insert	31	
2007882	Yellow	Paper Slot Lid Insert	31	
2007883	Yellow	Mixed Recycling Lid Insert	31	
2007884	Green	Closed Lid Insert	31	
2007885	Green	Bottles/Cans Lid Insert	31	
2007886	Green	Paper Slot Lid Insert	31	
2007887	Green	Mixed Recycling Lid Insert	31	
2007888	Blue	Closed Lid Insert	31	
2007889	Blue	Bottles/Cans Lid Insert	31	
2007890	Blue	Paper Slot Lid Insert	31	
2007891	Blue	Mixed Recycling Lid Insert	31	
2007892	Black	Closed Lid Insert	31	
2007893	Black	Bottles/Cans Lid Insert	31	
2007894	Black	Paper Slot Lid Insert	31	
2007895	Black	Mixed Recycling Lid Insert	31	
2007896	Dark Grey	Closed Lid Insert	31	
2007897	Dark Grey	Bottles/Cans Lid Insert	31	
2007898	Dark Grey	Paper Slot Lid Insert	31	
2007899	Dark Grey	Mixed Recycling Lid Insert	31	
2007900	Brown	Closed Lid Insert	31	
2007902	Brown	Bottles/Cans Lid Insert	31	

UTILITY AND RECYCLING REFUSE

DECORATIVE REFUSE

CLEANING

MATERIAL HANDLING

WASHROOM

FOODSERVICE

ACCESSORIES & INDEX



PART NO.	Color	DESCRIPTION	PAGE	UPC
2007903	Brown	Paper Slot Lid Insert	31	
2007904	Brown	Mixed Recycling Lid Insert	31	
2007905	Red	Billboard	31	
2007907	Yellow	Billboard	31	
2007908	Green	Billboard	31	
2007909	Blue	Billboard	31	
2007910	Black	Billboard	31	
2007911	Dark Grey	Billboard	31	
2007912	Brown	Billboard	31	
2007913	Light Grey	Starter Kit	30	
2007914	Black/Blue	2-Stream Station Landfill/ Mixed Recycling	30	
2007915	Black/Blue	2-Stream Station Landfill/Paper	30	
2007916	Black/Yellow	2-Stream Station Landfill/ Bottles/Cans	30	
2007917	Black/Blue/ Yellow	3-Stream Station Landfill/ Paper/Bottles/Cans	30	
2007918	Black/Blue/ Green	3-Stream Station Landfill/ Mixed Recycling/Compost	30	
2007919	Black/Blue/ Red/Yellow	4-Stream Station Landfill/ Paper/Plastic/Cans	30	
2007920	White	Label Kit: Chinese/English	31	
2007921	White	Label Kit: English (United Kingdom)	31	
2007922	White	Label Kit: French/English (Canada)	31	
2007923	White	Label Kit: Spanish	31	
2007924	White	Label Kit: English (Australia)	31	
2017059	Gray	Spill Mop Pads 10 ct	158	
2017060	Gray	Biohazard Spill Mop Pads 10 ct	158	
2017061	Yellow	Spill Mop Handle	158	
2017162	Gray	Spill Mop Storage Cabinet	158	
2017738	Black	BRUTE® 32G Lid – Open Top	13	
2017740	Red	BRUTE® 32G Lid – Bottles/Cans	13	
2017962	Red	BRUTE® 32G Lid – Open Top	13	
2017963	Yellow	BRUTE® 32G Lid – Open Top	13	
2017964	Dark Green	BRUTE® 32G Lid – Open Top	13	
2017965	Blue	BRUTE® 32G Lid – Open Top	13	
2018161	Yellow	BRUTE® 32G Lid – Bottles/Cans	13	
2018162	Dark Green	BRUTE® 32G Lid – Bottles/Cans	13	
2018163	Blue	BRUTE® 32G Lid – Bottles/Cans	13	
2018166	Red	BRUTE® 32G Lid – Paper	13	
2018167	Yellow	BRUTE® 32G Lid – Paper	13	
2018168	Dark Green	BRUTE® 32G Lid – Paper	13	
2018169	Blue	BRUTE® 32G Lid – Paper	13	
2018212	Red	BRUTE® 32G Lid – Mixed Recycling	13	
2018213	Yellow	BRUTE® 32G Lid – Mixed Recycling	13	
2018214	Dark Green	BRUTE® 32G Lid – Mixed Recycling	13	
2018215	Blue	BRUTE® 32G Lid – Mixed Recycling	13	
2018252	Blue	Slim Jim® Vertical Lid – Open Top	26	
2018218	Red	Slim Jim® Vertical Lid – Open Top	26	
2018219	Yellow	Slim Jim® Vertical Lid – Open Top	26	
2018220	Green	Slim Jim® Vertical Lid – Open Top	26	
2018253	Black	Slim Jim® Vertical Lid – Open Top	26	
2018254	Brown	Slim Jim® Vertical Lid – Open Top	26	
2018258	Blue	Slim Jim® Vertical Lid – Bottles/Cans	26	
2018255	Red	Slim Jim® Vertical Lid – Bottles/Cans	26	
2018256	Yellow	Slim Jim® Vertical Lid – Bottles/Cans	26	
2018257	Green	Slim Jim® Vertical Lid – Bottles/Cans	26	
2018260	Brown	Slim Jim® Vertical Lid – Bottles/Cans	26	
2018276	Blue	Slim Jim® Vertical Lid – Paper	26	
2018272	Red	Slim Jim® Vertical Lid – Paper	26	
2018274	Yellow	Slim Jim® Vertical Lid – Paper	26	
2018275	Green	Slim Jim® Vertical Lid – Paper	26	
2018278	Brown	Slim Jim® Vertical Lid – Paper	26	

PART NO.	Color	DESCRIPTION	PAGE	UPC
2018302	Blue	Slim Jim® Vertical Lid – Mixed Recycling	26	
2018279	Red	Slim Jim® Vertical Lid – Mixed Recycling	26	
2018280	Yellow	Slim Jim® Vertical Lid – Mixed Recycling	26	
2018301	Green	Slim Jim® Vertical Lid – Mixed Recycling	26	
2018304	Brown	Slim Jim® Vertical Lid – Mixed Recycling	26	
2018385	Red	Tilt Truck Placard	166	
2018386	Yellow	Tilt Truck Placard	166	
2018387	Green	Tilt Truck Placard	166	
2018388	Blue	Tilt Truck Placard	166	
2018389	Black	Tilt Truck Placard	166	
2018390	Brown	Tilt Truck Placard	166	
2018582		Enriched Lotion Antibacterial Hand Wash	194	
2018595		Enriched Foam Antibacterial Hand Wash — E2	191	
2018598		Foam Antibacterial Hand Wash — E2	198	
2018727	Black	Maximizer™ Push-To- Center Broom – 18" MP	128	
2018728	Black	Maximizer™ Push-To- Center Broom – 36" MP	128	
2018729	Gray	Maximizer™ Push-To- Center Broom – 18" Fine	128	
2018730	Gray	Maximizer™ Push-To- Center Broom – 36" Fine	128	
2018781	Black	Maximizer™ Heavy-Duty Stand Up Debris Pan	134	
2018782	Black	Maximizer™ 3-in-1 Floor Prep Tool	134	
2018784	Gray	Maximizer™ 3-in-1 Medium Scrubber Pad	134	
2018786	Green	Maximizer™ 3-in-1 Scuff Remover Pad	134	
2018787	Black	Maximizer™ 3-in-1 Replaceable Scraper	134	
2018788	Black	Maximizer™ Quick Change Storage Tray	135	
2018789	Yellow	Maximizer™ Quick Change Extension Handle	135	
2018790	Black	Maximizer™ Quick Change Duster	135	
2018801	Black	Maximizer™ Quick Change Squeegee	135	
2018802	Black	Maximizer™ Quick Change Scrub Brush	135	
2018803	Black	Maximizer™ Quick Change Floor Prep Tool	135	
2018804	Black	Maximizer™ Quick Change Microfiber Frame	135	
2018805	Black	Maximizer™ Quick Change Cleaning Kit	135	
2018806	Black	Maximizer™ Wet/ Dry Debris Pan	134	
2018807	Black	Maximizer™ Double Sided Broom/Squeegee	134	
2018808	Black	Maximizer™ Dust Frame, Handle, and Scraper – 24"	124	
2018809	Black	Maximizer™ Dust Frame, Handle, and Scraper – 36"	124	
2018810	Yellow	Maximizer™ Dust Mop Pad – 24"	124	
2018821	Yellow	Maximizer™ Dust Mop Pad – 36"	124	
2018822	Black	Maximizer™ EZ Access Scraper – Replacement	124	
2018824	Black	Maximizer™ Overhead Cleaning Tool	124	
2018825	Gray	11" HYGEN™ Microfiber Window Pad	124	

PART NO.	Color	DESCRIPTION	PAGE	UPC
2025501	White	Disposable Wet Mop	111	
2025502	White	Disposable Wet Mop	111	
2025503	White	Disposable Wet Mop	111	
2025504	White	Disposable Wet Mop	111	
2025505	White	Disposable Wet Mop	111	
2025506	White	Disposable Wet Mop	111	
2025507	White	Disposable Wet Mop	111	
2025508	White	Disposable Wet Mop	111	
2026695	Gray	Slim Jim® Under-Counter Container	33	
2026696	Black	Slim Jim® Under-Counter Container	33	
2026697	Brown	Slim Jim® Under-Counter Container	33	
2026698	Beige	Slim Jim® Under-Counter Container	33	
2026699	Blue	Slim Jim® Under-Counter Container	33	
2026700	Green	Slim Jim® Under-Counter Container	33	
2026721	Gray	Slim Jim® Under-Counter Container	33	
2026722	Black	Slim Jim® Under-Counter Container	33	
2026723	Brown	Slim Jim® Under-Counter Container	33	
2026724	Beige	Slim Jim® Under-Counter Container	33	
2026725	Blue	Slim Jim® Under-Counter Container	33	
2026726	Green	Slim Jim® Under-Counter Container	33	
2031093	Gray	Spill Mop Kit	158	
2031094	Gray	Biohazard Spill Mop Kit	158	
2031764	Yellow	35 qt WaveBrake® Side-Press Bucket and Wringer with Drain	96	
2031812	Green	Wastebasket, Medium	38	
2031824	Blue	Wastebasket, Medium	38	
2032955	Yellow	Slim Jim® Rim Caddy for 23 G Containers	24	
2032940	Black	Slim Jim® Rim Caddy for 23 G Containers	24	
2032954	Yellow	Slim Jim® Rim Caddy Kit	24	
2032953	Black	Slim Jim® Rim Caddy Kit	24	
2032952	Yellow	Slim Jim® 2-Stream Rim Caddy Kit	24	
2032936	Black	Slim Jim® 2-Stream Rim Caddy Kit	24	
2036121	White	Super Stitch® Cotton Scrubbing Wet Mop	107	
2036123	White	Super Stitch® Cotton Scrubbing Wet Mop	107	
2036100	White	Super Stitch® Cotton Scrubbing Wet Mop	107	
2040053		18" Fine Pet	127	
2039998		24" Fine Pet	127	
2040000		24" Fine Tampico	127	
2039999		24" Fine Horsehair	127	
2040055		18" Multi-Surface	127	
2040045		24" Multi-Surface	127	
2040046		24" Multi-Surface With Fg Hdl	127	
2040054		18" Heavy Duty Polypropylene	127	
2040041		24" Heavy Duty Palmyra	127	
2040050		24" Heavy Duty Polypropylene	127	
2040052		24" Fine Pet Assembled	127	
2040049		36" Fine Polypropylene	127	
2040048		24" Multi-Surface With Squeegee	127	
2040047		24" Medium Polypropylene Assembled	127	
2040042		24" Multi-Surface Assembled With Fg Hdl	127	

PART NO.	Color	DESCRIPTION	PAGE	UPC
2040044		36" Medium Polypropylene Assembled	127	
2040043		24" Heavy Duty Polypropylene Assembled	127	
2040051		36" Heavy Duty Polypropylene Assembled	127	
2044039	Black	BRUTE® Dome Top for 44-Gallon BRUTE® Container	13	
2044040		BRUTE® Dome Top for 55-Gallon BRUTE® Container	13	
2044151	Blue	BRUTE® Dome Top for 55-Gallon BRUTE® Container	13	
2044152	Black	BRUTE® Dome Top for 32-Gallon BRUTE® Container	13	
2044156	Blue	BRUTE® Recycling Container without Lid	12	
2044160	White	Wastebasket, Medium	38	
2052879	CLR	FreshWorks™ Produce Set	227	
2052933	CLR	FreshWorks™ Produce Set	227	
2052931	CLR	FreshWorks™ Produce Set	227	
2052878	CLR	FreshWorks™ Produce Set	227	
2052936	WHT	FreshWorks™ Produce Lid	227	
2052934	WHT	FreshWorks™ Produce Lid	227	
2052935	CLR	FreshWorks™ Produce Base	227	
2052932	CLR	FreshWorks™ Produce Base	227	
2052983	CLR	FreshWorks™ Produce Base	227	
2052880	CLR	FreshWorks™ Produce Base	227	
2064996	Yellow	26 qt WaveBrake® Bucket and Casters	96	
2064914	Yellow	35 qt WaveBrake® Bucket and Casters	96	
2064915	Yellow	WaveBrake® Side-Press Wringer	97	
2064885	Brown	WaveBrake® Side-Press Wringer	97	
2064888	Blue	WaveBrake® Side-Press Wringer	97	
2064884	Red	WaveBrake® Side-Press Wringer	97	
2064912	Green	WaveBrake® Side-Press Wringer	97	
2064960	Black	WaveBrake® Side-Press Wringer, Executive Series™	97	
2064959	Yellow	WaveBrake® Down-Press Wringer	97	
2065003	Brown	WaveBrake® Down-Press Wringer	97	
2064999	Blue	WaveBrake® Down-Press Wringer	97	
2065001	Red	WaveBrake® Down-Press Wringer	97	
2064953	Green	WaveBrake® Down-Press Wringer	97	
2064994	Black	WaveBrake® Down-Press Wringer, Executive Series™	97	
2064907	Red	35 qt WaveBrake® Dirty Water Bucket	97	
2064905	Gray	35 qt WaveBrake® Dirty Water Bucket	97	
2031763	Yellow	35 qt WaveBrake® Bucket and Casters with Drain	96	
2067692		Bumper Kit for Full Size Housekeeping Carts	143	
2067693		Bumper Kit for Compact Housekeeping Carts	143	
2080802		Enriched Foam Alcohol Hand Sanitizer — E3	191	
2080803		Foam Alcohol Hand Sanitizer	198	
2089820	Black	12G Resin Step-On	36	
2089821	Black	23G Resin Step-On	36	
2089824	Black	18G Resin Step-On	36	
2089825	Black	8G Resin Step-On	36	

UTILITY AND RECYCLING REFUSE

DECORATIVE REFUSE

CLEANING

MATERIAL HANDLING

WASHROOM

FOODSERVICE

ACCESSORIES & INDEX



PART NO.	Color	DESCRIPTION	PAGE	UPC
3485949		Microburst® Duet Gentle Breeze/Linen Fresh™	205	86876206357
3485950		Microburst® Duet Alpine Spring/Mountain Peaks	205	86876206364
3485951		Microburst® Duet Ocean Breeze/Sea Mist	205	86876206371
3485952		Microburst® Duet Cotton Berry/ Refreshing Citrus	205	86876206388
3486092		Microburst® Duet Variety Pack (1 of ea. refill)	205	86876207330
3486108		Light Commercial Microfiber Spray Mop (mop pad not included)	88	86876207446
3486110		15-oz Replacement Refill Cartridge for 3486108	88	86876207460
3486561		Enriched Foam Hand Wash	197	86876208528
3486562		Enriched Lotion Hand Wash	197	86876208535
3486571		Enriched Foam Hand Wash	197	86876208627
3486572		Enriched Lotion Hand Wash	197	86876208634
3486575		Enriched Foam Hand & Body Shampoo	197	86876208665
3486576		Enriched Lotion Hand & Body Shampoo	197	86876208672
3486577		Enriched Foam Alcohol Plus Hand Sanitizer — E3	197	86876208689
3486579		Enriched Foam Alcohol-Free Plus Hand Sanitizer — E3	197	86876208702
3486589	White	Rubbermaid Flex™ Dispenser White — 500 mL	196	86876208801
3486590	Black	Rubbermaid Flex™ Dispenser Black — 500 mL	196	86876208818
3486591	White	Rubbermaid Flex™ Dispenser White — 1000mL, 1300mL	196	86876208825
3486592	Black	Rubbermaid Flex™ Dispenser Black — 1000mL, 1300 mL	196	86876208832
3486593	Grey	Rubbermaid Flex™ Manual Dispenser Drip Tray — Grey	196	86876208849
4870577		AutoFlush® Power Adapter Kit	213	86876212969
20564020		Wheel for FG564000	186	86876213973
50564205		Axle for FG564000	186	86876217178
50565400		Axle for FG565461	186	86876183153
52564200		Axle for FG564200	186	
401290ZT		2nd Fixture Kit	214	763905012904
FG1000EBK	Black Gloss	Sand Urn	18	97591014905
FG100P00CLR	Clear	Cold Pan	230	86876120691
FG101100BLA	Black	Structural Foam Tilt Truck, Utility-Duty	164	86876184181
FG101300BLA	Black	Structural Foam Tilt Truck, Standard-Duty	164	86876184198
FG101P00CLR	Clear	Cold Pan	230	86876120714
FG10200S		200 lb Heavy-Duty Receiving Scale	236	
FG102500BLA	Black	Tilt Truck, Standard-Duty (RM)	165	86876183764
FG102641BLA	Black	Towable Trainable Tilt Truck, Heavy-Duty (RM)	166	
FG102600BLA	Black	Tilt Truck, Heavy-Duty (RM)	165	86876183771
FG102542BLA	Black	Forkliftable Tilt Truck, Standard-Duty (RM)	166	
FG102700BLA	Black	Lid for 1½-Cubic Yard Tilt Trucks	166	86876183849
FG102800BLA	Black	Domed Lid for ¾-Cubic-Yard Tilt Trucks	164	86876184235
FG102P23CLR	Clear	Cold Pan	230	86876172706
FG102P86CLR	Clear	Cold Pan	230	86876123579
FG103500BLA	Black	Tilt Truck, Standard-Duty (RM)	165	86876183788
FG103600BLA	Black	Tilt Truck, Heavy-Duty (RM)	165	86876183795
FG104500BLA	Black	Tilt Truck, Standard-Duty (RM)	165	86876183801
FG104600BLA	Black	Tilt Truck, Heavy-Duty (RM)	165	86876183801
FG104P00CLR	Clear	Cold Pan	230	86876120769
FG105443BLA	Black	Self-Dumping Hopper with four 6" dia (15.2 cm) Polyolefin Casters	167	86876179705

PART NO.	Color	DESCRIPTION	PAGE	UPC
FG105943BLA	Black	Self-Dumping Hopper with four 6" dia (15.2 cm) Polyolefin Casters	167	86876183917
FG105P00CLR	Clear	Cold Pan	230	86876120783
FG106P00CLR	Clear	Cold Pan	230	86876120806
FG107443BLA	Black	Self-Dumping Hopper with four 6" dia (15.2 cm) Polyolefin Casters	167	86876183979
FG108P23CLR	Clear	Cold Pan	230	86876172683
FG108P86CLR	Clear	Cold Pan	230	86876120837
FG10B100		Heavy-Duty Receiving Scale – Dual-Read	236	77177077050
FG110P00	Clear	Cold Pan	230	
FG111P00	Clear	Cold Pan	230	
FG112P00	Clear	Cold Pan	230	
FG113P00AMBR	Amber	Hot Pan	292	86876142785
FG113P24	Clear	Cold Pan	230	
FG114P00	Clear	Cold Pan	230	
FG114P86	Clear	Cold Pan	230	
FG116P00CLR	Clear	Cold Pan	230	86876120967
FG117P00CLR	Clear	Cold Pan	230	86876120981
FG118P00CLR	Clear	Cold Pan	230	86876121001
FG119P00CLR	Clear	Cold Pan	230	86876121025
FG120P00AMBR	Amber	Hot Pan	292	86876142853
FG120P24CLR	Clear	Cold Pan	230	86876121056
FG121P23CLR	Clear	Cold Pan	230	86876172669
FG121P86CLR	Clear	Cold Pan	230	86876121070
FG123P00CLR	Clear	Cold Pan	230	86876121094
FG124P00CLR	Clear	Cold Pan	230	86876121117
FG125P00CLR	Clear	Cold Pan	230	86876121131
FG126P00CLR	Clear	Cold Pan	230	86876121155
FG127P00AMBR	Amber	Hot Pan	292	86876142921
FG127P24CLR	Clear	Cold Pan	230	86876125009
FG128P23CLR	Clear	Cold Pan	230	86876172645
FG128P86CLR	Clear	Cold Pan	230	86876121186
FG130400BLA	Black	Tilt Truck, Utility-Duty (RM)	165	86876183702
FG130500BLA	Black	Tilt Truck, Standard-Duty (RM)	165	86876183719
FG130500DBLUE	Dark Blue	Tilt Truck, Standard-Duty (RM)	165	86876157215
FG130500RED	Red	Tilt Truck, Standard-Duty (RM)	165	86876157239
FG130500YEL	Yellow	Tilt Truck, Standard-Duty (RM)	165	86876157222
FG130542BLA	Black	Forkliftable Tilt Truck, Standard-Duty (RM)	166	86876179637
FG130573BLUE	Blue	Recycling Tilt Truck, Standard-Duty (RM)	165	86876194302
FG130600BLA	Black	Tilt Truck, Heavy-Duty (RM)	165	86876183726
FG130641BLA	Black	Towable Trainable Tilt Truck, Heavy-Duty (RM)	166	86876183856
FG130700BLA	Black	Lid for ½-Cubic Yard Tilt Trucks	165	86876183825
FG130700BLA	Black	Lid for ½-Cubic-Yard Tilt Trucks	166	86876183825
FG130P00CLR	Clear	Cold Pan	292	86876121193
FG131400BLA	Black	Tilt Truck, Utility-Duty (RM)	165	86876183733
FG131500BLA	Black	Tilt Truck, Standard-Duty (RM)	165	86876183740
FG131500DBLUE	Dark Blue	Tilt Truck, Standard-Duty (RM)	165	86876157246
FG131500RED	Red	Tilt Truck, Standard-Duty (RM)	165	86876157260
FG131500YEL	Yellow	Tilt Truck, Standard-Duty (RM)	165	86876157253
FG131542BLA	Black	Forkliftable Tilt Truck, Standard Duty (RM)	166	
FG131600BLA	Black	Tilt Truck, Heavy-Duty (RM)	165	86876183757
FG131641BLA	Black	Towable Trainable Tilt Truck, Heavy-Duty (RM)	166	86876183863
FG131700BLA	Black	Lid for 1-Cubic Yard Tilt Trucks	165	86876183832
FG131700BLA	Black	Lid for 1-Cubic-Yard Tilt Trucks	166	86876183832
FG131P00CLR	Clear	Cold Pan	230	86876121216
FG132P00CLR	Clear	Cold Pan	230	86876121230
FG133P00CLR	Clear	Cold Pan	230	86876121254
FG134P00CLR	Clear	Cold Pan	230	86876121278
FG134P86CLR	Clear	Cold Pan	230	86876121285
FG139P00CLR	Clear	Cold Pan	230	86876121308

PART NO.	Color	DESCRIPTION	PAGE	UPC
FG140P00CLR	Clear	Cold Pan	230	86876121322
FG141P00CLR	Clear	Cold Pan	230	86876121346
FG142P00WHT	White	Cold Pan	230	86876155730
FG143P00WHT	White	Cold Pan	230	86876155747
FG144P00	White	Cold Pan	230	
FG145P00WHT	White	Cold Pan	230	86876155761
FG146P00WHT	White	Cold Pan	230	86876155778
FG147P00WHT	White	Cold Pan	230	86876155785
FG172000GRAY	Gray	Palletote® Lid for FG172100, FG172200	187	86876001075
FG172000GRAY	Gray	Palletote® Lid for FG172100, FG172200	315	86876001075
FG172100GRAY	Gray	Palletote® Box	187	86876001136
FG172100GRAY	Gray	Palletote® Box	315	86876001136
FG172200GRAY	Gray	Palletote® Box	187	86876001235
FG172200GRAY	Gray	Palletote® Box	315	86876001235
FG173000GRAY	Gray	Palletote® Lid for FG173100	187	86876001280
FG173000GRAY	Gray	Palletote® Lid for FG173100	315	86876001280
FG173100GRAY	Gray	Palletote® Box	187	86876001334
FG173100GRAY	Gray	Palletote® Box	315	86876001334
FG1855BK	Black Gloss	Fits FGMT32, FGH55, FGSBR54	38	97591006214
FG1855BK	Black Gloss	Steel Drum Top for use w/ 55-Gal Steel Drum, FGSBR52	64	97591006214
FG1855EGN	Green Gloss	Fits FGMT32, FGH55, FGSBR52	38	97591000601
FG1855EGN	Green Gloss	Steel Drum Top for use w/ 55-Gal Steel Drum, FGSBR52	64	97591000601
FG1855RD	Red Gloss	Fits FGMT32, FGH55, FGSBR53	38	97591019504
FG1855RD	Red Gloss	Steel Drum Top for use w/ 55-Gal Steel Drum, FGSBR52	64	97591019504
FG190100		Scraper	232	86876155464
FG190500		Scraper	232	86876155525
FG190600		Scraper	232	86876155518
FG191300		Scraper-Icing Blade	232	86876155501
FG193300WHT	White	Spoon-Shaped Spatula	232	86876162226
FG193400WHT	White	Spoon-Shaped Spatula	232	86876162233
FG193800WHT	White	Spoon-Shaped Spatula	232	86876162240
FG1962000000	Red	Color Coded High-Heat Spatula	295	86876232967
FG1963000000	Red	Color Coded High-Heat Spatula	295	86876148992
FG196200	Red	Color Coded High-Heat Spatula	232	86876148992
FG196300		High-Heat Scraper	232	86876149005
FG196400		High-Heat Scraper	232	86876149012
FG196600RED	Red	High-Heat Spoon Scraper	232	86876159684
FG196700RED	Red	High-Heat Spoon Scraper	232	86876159691
FG196800RED	Red	High-Heat Spoon Scraper	232	86876159707
FG199200GRAY	Gray	Closet Organizer/Tool Holder Kit	148	86876127881
FG199300GRAY	Gray	Closet Organizer/Tool Holder Kit	148	86876127898
FG199400YEL	Yellow	Value Kit (2 S-Hooks/ 1 Double Hook)	148	86876127904
FG200500CHAR	Chrome	Heavy-Duty Dust Pan	132	86876116960
FG200P00AMBR	Amber	Hot Pan	292	86876142662
FG201P00AMBR	Amber	Hot Pan	292	86876142679
FG202P23AMBR	Amber	Hot Pan	292	86876172713
FG2030BK	Black	Fits FGMT22, FGH13	38	97591020708
FG2030BK	Black	Steel Drum Top for use w/ 30-Gal Steel Drum	64	97591020708
FG2030BR	Brown Gloss	Fits FGMT22, FGH14	38	97591020425
FG2030BR	Brown Gloss	Steel Drum Top for use w/ 30-Gal Steel Drum	64	97591020425
FG2030EGN	Green Gloss	Fits FGMT22, FGH15	38	97591002520
FG2030EGN	Green Gloss	Steel Drum Top for use w/ 30-Gal Steel Drum	64	97591002520
FG204P00AMBR	Amber	Hot Pan	292	86876142693
FG205P00AMBR	Amber	Hot Pan	292	86876142709
FG206P00AMBR	Amber	Hot Pan	292	86876142716
FG208P23AMBR	Amber	Hot Pan	292	86876172690
FG208P86AMBR	Amber	Hot Pan	292	86876142730

PART NO.	Color	DESCRIPTION	PAGE	UPC
FG210P00AMBR	Amber	Hot Pan	292	86876142754
FG211P00AMBR	Amber	Hot Pan	292	86876142761
FG212P00AMBR	Amber	Hot Pan	292	86876142778
FG212P00BLA	Black	Hot Pan	292	86876155860
FG214P00AMBR	Amber	Hot Pan	292	86876142792
FG214P86AMBR	Amber	Hot Pan	292	86876142808
FG216P00AMBR	Amber	Hot Pan	292	86876142815
FG217P00AMBR	Amber	Hot Pan	292	86876142822
FG218800WHT	White	Ironing Organizer	148	86876167016
FG218P00AMBR	Amber	Hot Pan	292	86876142839
FG221P23AMBR	Amber	Hot Pan	292	86876172676
FG221P86AMBR	Amber	Hot Pan	292	86876142877
FG223P00AMBR	Amber	Hot Pan	292	86876142884
FG224P00AMBR	Amber	Hot Pan	292	86876142891
FG225P00AMBR	Amber	Hot Pan	292	86876142907
FG228P23AMBR	Amber	Hot Pan	292	86876172652
FG228P86AMBR	Amber	Hot Pan	292	86876142945
FG230P00AMBR	Amber	Hot Pan	292	86876142952
FG231P00AMBR	Amber	Hot Pan	292	86876142969
FG232P00AMBR	Amber	Hot Pan	292	86876142976
FG234P00AMBR	Amber	Hot Pan	292	86876142990
FG239P00AMBR	Amber	Hot Pan	292	86876143010
FG241P00AMBR	Amber	Hot Pan	292	86876143034
FG245506WHT	Wht	Ironing Organizer	148	86876147704
FG252300BEIG	Beige	Mobile Two-Step Stepstool	148	86876031645
FG252300BLA	Black	Mobile Two-Step Stepstool	148	86876009323
FG253100BLA	Black	Executive Lobby Pro® Dust Pan, Long Handle	129	86876156164
FG253200BLA	Black	Executive Lobby Pro® Dust Pan with Cover, Long Handle	129	86876156171
FG253300BLA	Black	Lobby Pro® Deluxe Upright Dust Pan with Cover and Adjustable Handle Grip	129	86876156188
FG253400BLA	Black	Lobby Pro® Upright Dust Pan Adjustable Handle Grip	129	86876156195
FG253500BLA	Black	Lobby Pro® Upright Dust Pan Hanger Bracket	133	86876156201
FG253600BLA	Black	Executive Lobby Broom w/ Wood Handle	129	86876156232
FG254000BEIG	Beige	Fire-Resistant Wastebasket	40	86876117158
FG254100BEIG	Beige	Fire-Resistant Wastebasket	40	86876117196
FG254100BLA	Black	Fire-Resistant Wastebasket	40	86876117165
FG254100GRAY	Gray	Fire-Resistant Wastebasket	40	86876117172
FG254300BEIG	Beige	Fire-Resistant Wastebasket	40	86876117264
FG254300BLA	Black	Fire-Resistant Wastebasket	40	86876117233
FG254300GRAY	Gray	Fire-Resistant Wastebasket	40	86876117240
FG254400BEIG	Beige	Fire-Resistant Wastebasket	40	86876117295
FG256B00BRN	Brown	Glutton® Container	64	86876011029
FG256B00WHT	Off-White	Glutton® Container	64	86876011043
FG256B73BLUE	Blue	Glutton® Recycling Container	41	86876194142
FG256K00GRAY	Gray	Rigid Liner for Glutton® Container	64	86876011197
FG256L00DBLUE	Dark Blue	Glutton® Bottle and Can Recycling Top for FG256B73 Container	41	86876159882
FG256V00BRN	Brown	Glutton® Hooded Top without doors for FG256B00 Containers	64	86876011241
FG256V00RED	Red	Glutton® Hooded Top without doors for FG256B00 Containers	64	86876011272
FG256X00BRN	Brown	Glutton® Hooded Top with doors for FG256B00 Containers	64	86876011302
FG256X00RED	Red	Glutton® Hooded Top with doors for FG256B00 Containers	64	86876011333
FG257088BEIG	Beige	GroundsKeeper® Smoking Management Receptacle	66	86876166859
FG257088BLA	Black	GroundsKeeper® Smoking Management Receptacle	66	86876166873

UTILITY AND RECYCLING REFUSE

DECORATIVE REFUSE

CLEANING

MATERIAL HANDLING

WASHROOM

FOODSERVICE

ACCESSORIES & INDEX



UTILITY AND
RECYCLING REFUSE

PART NO.	Color	DESCRIPTION	PAGE	UPC
FG257088BRN	Brown	GroundsKeeper® Smoking Management Receptacle	66	86876166866
FG258500BLA	Black	Classic Smoking Urn with Metal Ash Tray Top	65	86876011845

DECORATIVE REFUSE

FG258600BLA	Black	Classic Smoking Urn, Ash/Trash w/ Metal Ash Tray Top and Metal Liner	65	86876011944
FG260900DGRN	Dark Green	Lid for 10-Gallon BRUTE® Container	13	86876203035
FG260900GRAY	Gray	Lid for 10-Gallon BRUTE® Container	13	86876012385
FG260900RED	Red	Lid for 10-Gallon BRUTE® Container	13	86876203011
FG260900WHT	White	Lid for 10-Gallon BRUTE® Container	13	86876012415
FG260900YEL	Yellow	Lid for 10-Gallon BRUTE® Container	13	86876203028

CLEANING

FG261000DGRN	Dark Green	BRUTE® Container without Lid	12	86876203004
FG261000GRAY	Gray	BRUTE® Container without Lid	12	86876012477
FG261000RED	Red	BRUTE® Container without Lid	12	86876202984
FG261000WHT	White	BRUTE® Container without Lid	12	86876012491
FG261000YEL	Yellow	BRUTE® Container without Lid	12	86876202991
FG261088WHT	White	BRUTE® Container without Lid	80	86876171075
FG261088WHT	White	BRUTE® Container without Lid	224	86876171075
FG261400GRAY	Gray	Round Bucket	117	86876012903
FG261400RED	Red	Round Bucket	117	86876012910
FG261700GRAY	Gray	Double Pail	117	86876013207

MATERIAL HANDLING

FG261960BLA	Black	Lid for 20-Gallon BRUTE® Container	13	86876191752
FG261960DGRN	Dark Green	Lid for 20-Gallon BRUTE® Container	13	86876203073
FG261960GRAY	Gray	Lid for 20-Gallon BRUTE® Container	13	86876191714
FG261960RED	Red	Lid for 20-Gallon BRUTE® Container	13	86876203066
FG261960WHT	White	Lid for 20-Gallon BRUTE® Container	13	86876191738
FG261960YEL	Yellow	Lid for 20-Gallon BRUTE® Container	13	86876191745
FG262000BLU	Blue	BRUTE® Container without Lid	12	86876047462
FG262000DGRN	Dark Green	BRUTE® Container without Lid	12	86876203059
FG262000GRAY	Gray	BRUTE® Container without Lid	12	86876013436
FG262000RED	Red	BRUTE® Container without Lid	12	86876203042
FG262000WHT	White	BRUTE® Container without Lid	12	86876013450
FG262000YEL	Yellow	BRUTE® Container without Lid	12	86876013474

WASHROOM

FG262073BLU	Blue	BRUTE® Recycling Container without Lid	12	86876194265
FG262088WHT	White	BRUTE® Container without Lid	80	86876171051
FG262400WHT	White	GreensKeeper® Container with Lid and Dolly	81	86876013979
FG262888GRAY	Gray	Double Pail	117	86876194098
FG263100BLU	Blue	Lid for 32-Gallon BRUTE® Container	13	86876192018
FG263100DGRN	Dark Green	Lid for 32-Gallon BRUTE® Container	13	86876179040
FG263100GRAY	Gray	Lid for 32-Gallon BRUTE® Container	13	86876014655
FG263100RED	Red	Lid for 32-Gallon BRUTE® Container	13	86876014013
FG263100WHT	White	Lid for 32-Gallon BRUTE® Container	13	86876014662
FG263100YEL	Yellow	Lid for 32-Gallon BRUTE® Container	13	86876014051

FOODSERVICE

FG263200BLU	Blue	BRUTE® Container without Lid	12	86876047493
FG263200BLU	Blue	BRUTE® 32-Gallon Container	141	86876047493
FG263200DGRN	Dark Green	BRUTE® Container without Lid	12	86876179026
FG263200DGRN	Dark Green	BRUTE® 32-Gallon Container	141	86876179026
FG263200GRAY	Gray	BRUTE® Container without Lid	12	86876014679
FG263200GRAY	Gray	BRUTE® 32-Gallon Container	141	86876014679
FG263200RED	Red	BRUTE® Container without Lid	12	86876014112
FG263200RED	Red	BRUTE® 32-Gallon Container	141	86876014112
FG263200WHT	White	BRUTE® 32-Gallon Container	141	

ACCESSORIES
& INDEX

PART NO.	Color	DESCRIPTION	PAGE	UPC
FG263200WHT	White	BRUTE® Container without Lid	12	86876014136
FG263200YEL	Yellow	BRUTE® Container without Lid	12	86876014150
FG263200YEL	Yellow	BRUTE® 32-Gallon Container	141	86876014150
FG263288WHT	White	BRUTE® Container without Lid	224	
FG263600WHT	White	GreensKeeper® Container with Lid and Dolly	81	86876015386

FG263600WHT	White	GreensKeeper® Container with Lid and Dolly	233	86876015386
FG263788GRAY	Gray	BRUTE® Dome Top for 32-Gallon BRUTE® Container	13	86876148695
FG263788RED	Red	BRUTE® Dome Top for 32-Gallon BRUTE® Container	13	86876148701

FG264000BLA	Black	BRUTE® Dolly for 20-, 32-, 44-, and 55-Gallon BRUTE® Containers	14	86876015492
FG264000BLA	Black	BRUTE® Dolly for FG9G7400, FG9G7500, FG262000, and FG263200	14	86876015492

FG264000BLA	Black	BRUTE® Dolly for FG9G7400, FG9G7500, FG262088, and FG263288	224	86876015492
-------------	-------	---	-----	-------------

FG264043BLA	Black	BRUTE® Quiet Dolly for 20-, 32-, 44-, and 55-Gallon BRUTE® Containers	14	86876173208
-------------	-------	---	----	-------------

FG264200YEL	Yellow	BRUTE® Caddy Bag for 32- and 44-Gallon BRUTE® Containers	15	86876015621
-------------	--------	--	----	-------------

FG263273BLU	Blue	BRUTE® Recycling Container without Lid	12	86876191691
-------------	------	--	----	-------------

FG264307	Blue	BRUTE® Recycling Container without Lid	12	
----------	------	--	----	--

FG264360BLA	Black	BRUTE® Container without Lid	12	86876183566
-------------	-------	------------------------------	----	-------------

FG264360BLA	Black	BRUTE® 44-Gallon Utility Container with Venting Channels	141	86876183566
-------------	-------	--	-----	-------------

FG264360BLU	Blue	BRUTE® Container without Lid	12	86876183580
-------------	------	------------------------------	----	-------------

FG264360BLU	Blue	BRUTE® 44-Gallon Utility Container with Venting Channels	141	86876183580
-------------	------	--	-----	-------------

FG264360GRAY	Gray	BRUTE® Container without Lid	12	86876183559
--------------	------	------------------------------	----	-------------

FG264360GRAY	Gray	BRUTE® 44-Gallon Utility Container with Venting Channels	141	86876183559
--------------	------	--	-----	-------------

FG264360RED	Red	BRUTE® Container without Lid	12	86876191684
-------------	-----	------------------------------	----	-------------

FG264360RED	Red	BRUTE® 44-Gallon Utility Container with Venting Channels	141	86876191684
-------------	-----	--	-----	-------------

FG264360YEL	Yellow	BRUTE® Container without Lid	12	86876183573
-------------	--------	------------------------------	----	-------------

FG264360YEL	Yellow	BRUTE® 44-Gallon Utility Container with Venting Channels	141	86876183573
-------------	--------	--	-----	-------------

FG264560BLA	Black	Lid for 44-Gallon BRUTE® Containers	13	86876183597
-------------	-------	-------------------------------------	----	-------------

FG264560DGRN	Dark Green	Lid for 44-Gallon BRUTE® Containers	13	86876187472
--------------	------------	-------------------------------------	----	-------------

FG264560GRAY	Gray	Lid for 44-Gallon BRUTE® Containers	13	86876187465
--------------	------	-------------------------------------	----	-------------

FG264560RED	Red	Lid for 44-Gallon BRUTE® Containers	13	86876187489
-------------	-----	-------------------------------------	----	-------------

FG264560WHT	White	Lid for 44-Gallon BRUTE® Containers	13	86876187496
-------------	-------	-------------------------------------	----	-------------

FG264560YEL	Yellow	Lid for 44-Gallon BRUTE® Containers	13	86876187502
-------------	--------	-------------------------------------	----	-------------

FG264600BLA	Black	BRUTE® Tandem Dolly for 20-, 32-, 44-, and 55-Gallon BRUTE® Containers	14	86876161779
-------------	-------	--	----	-------------

FG264788GRAY	Gray	BRUTE® Dome Top for 44-Gallon BRUTE® Container	13	86876148718
--------------	------	--	----	-------------

FG264788RED	Red	BRUTE® Dome Top for 44-Gallon BRUTE® Container	13	86876148725
-------------	-----	--	----	-------------

FG264900GRAY	Gray	Maid Caddy	15	86876016482
--------------	------	------------	----	-------------

FG265000BLA	Black	Universal Drum Dolly for 55-Gallon BRUTE® Containers	14	86876016499
-------------	-------	--	----	-------------

FG265400DGRN	Dark Green	Lid for 55-Gallon BRUTE® Container	13	86876203127
--------------	------------	------------------------------------	----	-------------

PART NO.	Color	DESCRIPTION	PAGE	UPC
FG265400GRAY	Gray	Lid for 55-Gallon BRUTE® Container	13	86876016505
FG265400RED	Red	Lid for 55-Gallon BRUTE® Container	13	86876203141
FG265400WHT	White	Lid for 55-Gallon BRUTE® Container	13	86876203134
FG265400YEL	Yellow	Lid for 55-Gallon BRUTE® Container	13	86876203158
FG265500DGRN	Dark Green	BRUTE® Container without Lid	12	86876203080
FG265500GRAY	Gray	BRUTE® Container without Lid	12	86876005318
FG265500RED	Red	BRUTE® Container without Lid	12	86876203103
FG265500WHT	White	BRUTE® Container without Lid	12	86876203097
FG265500YEL	Yellow	BRUTE® Container without Lid	12	86876203110
FG265788GRAY	Gray	BRUTE® Dome Top for 55-Gallon BRUTE® Container	13	86876148732
FG265788RED	Red	BRUTE® Dome Top for 55-Gallon BRUTE® Container	13	86876148749
FG266400BEIG	Beige	Untouchable® Square Swing Top for FG395800, FG395900 Containers	37	86876016819
FG266400GRAY	Gray	Untouchable® Square Swing Top for FG395800, FG395900 Containers	37	86876057621
FG267200BEIG	Beige	Untouchable® Round Swing Top for FG294700, FG354600 Containers	37	86876016987
FG267360BEIG	Beige	Slim Jim® Swing Lid for Slim Jim® Containers	26	86876203189
FG267360BLA	Black	Slim Jim® Swing Lid for Slim Jim® Containers	26	86876186406
FG267360BLUE	Blue	Slim Jim® Swing Lid for Slim Jim® Containers	26	86876187557
FG267360GRAY	Gray	Slim Jim® Swing Lid for Slim Jim® Containers	26	86876187533
FG267400BLA	Black	Executive Slim Jim® Hinged Lid for Slim Jim® Containers	26	86876186413
FG268888L	Gray	Slim Jim® Handle Top	26	
FG268988BEIG	Beige	Untouchable® Swing Top for FG356907, FG356988 Containers	37	86876192544
FG268988BLA	Black	Untouchable® Swing Top for FG356907, FG356988 Containers	37	86876191486
FG268988GRAY	Gray	Untouchable® Swing Top for FG356907, FG356988 Containers	37	86876203530
FG269000BLUE	Blue	Untouchable® Paper Recycling Top for FG356988 Containers	37	86876191493
FG269100BLUE	Blue	Untouchable® Bottles and Cans Recycling Top for FG356988 Container	37	86876191509
FG269288BLUE	Blue	Slim Jim® Bottles and Cans Recycling Lid for Slim Jim® Containers	26	86876188431
FG269288BRN	Brown	Slim Jim® Bottles and Cans Recycling Lid for Slim Jim® Containers	26	86876147612
FG269288GRN	Green	Slim Jim® Bottles and Cans Recycling Lid for Slim Jim® Containers	26	86876147629
FG269288RED	Red	Slim Jim® Bottles and Cans Recycling Lid for Slim Jim® Containers	26	86876203622
FG269288YEL	Yellow	Slim Jim® Bottles and Cans Recycling Lid for Slim Jim® Containers	26	86876203639
FG270388BLUE	Blue	Slim Jim® Paper Recycling Lid for Slim Jim® Containers	26	86876147636
FG270388GRN	Green	Slim Jim® Paper Recycling Lid for Slim Jim® Containers	26	86876191813
FG279100DBLUE	Dark Blue	Untouchable® Bottle and Can Recycling Top for FG395873, FG395973 Containers	37	86876156546

PART NO.	Color	DESCRIPTION	PAGE	UPC
FG279400DBLUE	Dark Blue	Untouchable® Paper Recycling Top for FG395806, FG395906 Containers	37	86876156553
FG288200CLR	Clear	Bouncer® Bar Scoop	233	86876017854
FG288400CLR	Clear	Bouncer® Utility Scoop	233	86876017878
FG288500WHT	White	Utility Scoop	233	86876017915
FG288600CLR	Clear	Bouncer® Utility Scoop	233	86876017939
FG289000BLA	Black	Condiment Dispenser with Six 1 U.S. pt (0.5 L) Inserts	304	86876120547
FG294700GRAY	Gray	Untouchable® Round Container	37	86876018288
FG295073BLA	Black	Side Bin Recycling Center	38	86876200584
FG295073BLUE	Blue	Side Bin Recycling Center	38	86876200607
FG295073GRAY	Gray	Side Bin Recycling Center	38	86876200591
FG295500BEIG	Beige	Wastebasket, Small	38	86876026030
FG295500BLA	Black	Wastebasket, Small	38	86876026061
FG295500GRAY	Gray	Wastebasket, Small	38	86876018523
FG295573BLUE	Blue	Deskside Recycling Container, Small with Universal Recycle Symbol	38	86876194166
FG295600BEIG	Beige	Wastebasket, Medium	38	86876012538
FG295600BLA	Black	Wastebasket, Medium	38	86876018837
FG295600GRAY	Gray	Wastebasket, Medium	38	86876018851
FG295606GRN	Green	Deskside Recycling Container, Medium with Universal Recycle Symbol	38	86876191806
FG295673BLUE	Blue	Deskside Recycling Container, Medium with Universal Recycle Symbol	38	86876194173
FG295700BEIG	Beige	Wastebasket, Large	38	86876019162
FG295700BLA	Black	Wastebasket, Large	38	86876019179
FG295700GRAY	Gray	Wastebasket, Large	38	86876019193
FG295773BLUE	Blue	Deskside Recycling Container, Large with Universal Recycle Symbol	38	86876194180
FG296300GRAY	Gray	Round Bucket	116	86876019391
FG296300RED	Red	Round Bucket	116	86876019353
FG3062PRPERI	Periwinkle	Economy Pitcher	305	71691012061
FG306409WHT	White	Mixing Pitcher	305	71691306412
FG306600BEIG	Beige	Untouchable® Top for FG295600 Container	39	86876147735
FG306600BLA	Black	Untouchable® Top for FG295600 Container	39	86876147728
FG306700BLA	Black	Untouchable® Top for FG295700 Container	39	86876147742
FG315488BLA	Black	Deluxe Carry Caddy	149	86876193695
FG321000CLR	Clear	Bouncer® Measuring Cup	233	86876019650
FG321500CLR	Clear	Bouncer® Measuring Cup	233	86876019667
FG321600CLR	Clear	Bouncer® Measuring Cup	233	86876019681
FG321700CLR	Clear	Bouncer® Measuring Cup	233	86876019704
FG321800CLR	Clear	Bouncer® Measuring Cup	233	86876019728
FG330000CLR	Clear	Food/Tote Box	226	86876019766
FG330100CLR	Clear	Food/Tote Box	226	86876019780
FG330200CLR	Clear	Lid for FG330000, FG330100, FG330600, FG330800, FG332800 Food/Tote Boxes	226	86876019803
FG330300CLR	Clear	Colander for Tote Boxes 6" deep or greater	226	86876019841
FG330400CLR	Clear	Food/Tote Box	226	86876019865
FG330600CLR	Clear	Food/Tote Box	226	86876019889
FG330700CLR	Clear	Food/Tote Box	226	86876019902
FG330800CLR	Clear	Food/Tote Box	226	86876019926
FG330900CLR	Clear	Food/Tote Box	226	86876019957
FG331000CLR	Clear	Lid for FG330400, FG330700, FG330900 Food/Tote Boxes	226	86876019971
FG331400CLR	Clear	Drain Tray	226	86876206449
FG331500BLA	Black	ProServe® Prep Cart with Cutting Board (8-slot end loader for full-size insert pans)	240	86876155419

UTILITY AND RECYCLING REFUSE

DECORATIVE REFUSE

CLEANING

MATERIAL HANDLING

WASHROOM

FOODSERVICE

ACCESSORIES & INDEX



PART NO.	Color	DESCRIPTION	PAGE	UPC
FG331600BLA	Black	ProServe® Prep Cart with Cutting Board (8-slot side loader for food boxes and sheet pans)	240	86876155426
FG331700BLA	Black	ProServe® Rack (18-slot end loader for full-size insert pans)	240	86876155433
FG331700WHT	Off-White	ProServe® Rack (18-slot end loader for full-size insert pans)	240	86876149166
FG331800CLR	Clear	Drain Tray	226	86876206456
FG331900WHT	Off-White	ProServe® Rack (18-slot side loader for food boxes and sheet pans)	240	86876149180
FG332000BLA	Black	ProServe® Rack (18-slot end loader for food boxes and sheet pans)	240	86876155389
FG332000WHT	Off-White	ProServe® Rack (18-slot end loader for food boxes and sheet pans)	240	86876155372
FG332400BLA	Black	ProServe® Rack 18-slot dual loader for full-size insert pans)	240	86876155402
FG332400WHT	Off-White	ProServe® Rack 18-slot dual loader for full-size insert pans)	240	86876155396
FG332800CLR	Clear	Food/Tote Box	226	86876020205
FG333100CLR	Clear	Bouncer® II Pitcher	241	86876020274
FG333400CLR	Clear	Bouncer® II Pitcher	241	86876020335
FG333500CLR	Clear	Bouncer® Pitcher	241	86876020342
FG333600CLR	Clear	Bouncer® Pitcher	241	86876020366
FG333700CLR	Clear	Bouncer® Pitcher	241	86876020380
FG333800CLR	Clear	Bouncer® Pitcher	241	86876024234
FG333800GOLD	Gold	Bouncer® Pitcher	241	86876020427
FG333900CLR	Clear	Bouncer® Pitcher	241	86876020472
FG334900GRAY	Gray	Bus/Utility Box	176	86876021011
FG334900GRAY	Gray	Bus/Utility Box	241	86876021011
FG334900WHT	White	Bus/Utility Box	176	86876129694
FG334900WHT	White	Bus/Utility Box	176	86876129694
FG334900WHT	White	Bus/Utility Box	241	86876129694
FG334992GRAY	Gray	Bus/Utility Box, Bulk Pack	176	86876021097
FG334992WHT	White	Bus/Utility Box, Bulk Pack	241	86876155303
FG335000BRN	Brown	Divided Bus/Utility Box	241	86876021103
FG335100BRN	Brown	Undivided Bus/Utility Box	241	86876021141
FG335100GRAY	Gray	Undivided Bus/Utility Box	241	86876021165
FG335192BRN	Brown	Undivided Bus/Utility Box, Bulk Pack	241	86876140989
FG335192GRAY	Gray	Undivided Bus/Utility Box, Bulk Pack	241	86876140996
FG335388BLA	Black	Refuse Bin	144	86876162844
FG335388BLA	Black	Refuse Bin	176	86876162844
FG335388BLA	Black	Refuse Bin	183	86876162844
FG335488BLA	Black	Utility Bin	144	86876162851
FG335488BLA	Black	Utility Bin	183	86876162851
FG335488BLA	Black	Utility Bin	176	86876162851
FG335588PLAT	Platinum	Utility Cart with Enclosed End Panels	177	86876173154
FG336200GRAY	Gray	Cutlery Bin, 4 Compartments	241	86876042979
FG342100BLA	Black	Utility Cart with 3" dia (7.6 cm) Swivel Casters and End Panels	177	86876159530
FG342488BLA	Black	Utility Cart with 4" dia (10.2 cm) Swivel Casters	313	86876159509
FG342488BLA	Black	Utility Cart with 4" dia (10.2 cm) Swivel Casters	177	86876159509
FG342488WHT	Off-White	Utility Cart with 4" dia (10.2 cm) Swivel Casters	177	86876159516
FG342488WHT	Off-White	Utility Cart with 4" dia (10.2 cm) Swivel Casters	313	86876159516
FG342488PLAT	Platinum	Utility Cart with 4" dia (10.2 cm) Swivel Casters	177	86876159493
FG342488PLAT	Platinum	Utility Cart with 4" dia (10.2 cm) Swivel Casters	313	86876159493
FG342488RED	Red	Utility Cart with 4" dia (10.2 cm) Swivel Casters	177	86876164718
FG342488RED	Red	Utility Cart with 4" dia (10.2 cm) Swivel Casters	313	86876164718

PART NO.	Color	DESCRIPTION	PAGE	UPC
FG345600AMBR	Amber	Hot Pan	230	86876142747
FG345700BLA	Black	Utility Cart with Lockable Doors, Sliding Drawer, and 4" dia (10.2 cm) Swivel Casters	177	86876163087
FG350000WHT	White	Food/Tote Box	226	86876022650
FG350100WHT	White	Food/Tote Box	226	86876022711
FG350200WHT	White	Lid for FG350000, FG350100, FG350600, FG350800, FG352800 Food/Tote Boxes	226	86876022759
FG350400WHT	White	Food/Tote Box	226	86876022780
FG350600WHT	White	Food/Tote Box	226	86876022827
FG350700WHT	White	Food/Tote Box	226	86876022858
FG350800WHT	White	Food/Tote Box	226	86876022896
FG350900WHT	White	Food/Tote Box	226	86876022971
FG351000WHT	White	Lid for FG350400, FG350700, FG350900 Food/Tote Boxes	226	86876023046
FG352000BEIG	Beige	Untouchable® Half Round Container	37	86876023121
FG352000GRAY	Gray	Untouchable® Half Round Container	37	86876023138
FG352073BLUE	Blue	Half-Round Recycling Container	16	86876194234
FG352073BLUE	Blue	Half-Round Recycling Container	37	86876194234
FG352600GRAY	Gray	BRUTE® Square Container without Lid	15	86876044294
FG352600RED	Red	BRUTE® Square Container without Lid	15	86876147773
FG352600WHT	White	BRUTE® Square Container without Lid	15	86876044300
FG352700GRAY	Gray	Lid for FG352600 Container	15	86876044324
FG352700WHT	White	Lid for FG352600 Container	15	86876044331
FG352800WHT	White	Food/Tote Box	226	86876023220
FG352900RED	Red	Snap-Lock® Lid for FG352600 Container	15	86876156041
FG353000BLA	Black	BRUTE® Square Dolly for BRUTE® Square Containers	15	86876044355
FG353000BLA	Black	BRUTE® Square Dolly	156	86876044355
FG353000BLA	Black	BRUTE® Square Dolly	157	86876044355
FG353600GRAY	Gray	BRUTE® Square Container without Lid	15	86876044362
FG353600WHT	White	BRUTE® Square Container without Lid	15	86876044379
FG353900GRAY	Gray	Lid for FG353600 Container	15	86876044393
FG353900WHT	White	Lid for FG353600 Container	15	86876044409
FG354007BLUE	Blue	Slim Jim® Container with Venting Channels – Recycling	22	86876186383
FG354007BLUE	Blue	Slim Jim® with Venting Channels – Recycling	141	86876186383
FG354007GRN	Green	Slim Jim® Container with Venting Channels – Recycling	22	86876186390
FG354007GRN	Green	Slim Jim® with Venting Channels – Recycling	141	86876186390
FG354060BEIG	Beige	Slim Jim® Container with Venting Channels	22	86876186369
FG354060BEIG	Beige	Slim Jim® with Venting Channels	141	86876186369
FG354060BLA	Black	Slim Jim® Container with Venting Channels	22	86876186352
FG354060BLA	Black	Slim Jim® with Venting Channels	141	86876186352
FG354060GRAY	Gray	Slim Jim® Container with Venting Channels	22	86876186376
FG354060GRAY	Gray	Slim Jim® with Venting Channels	141	86876186376
FG354300GRAY	Gray	Funnel Top for 32-Gallon BRUTE® Containers	13	86876023428
FG354600GRAY	Gray	Untouchable® Round Container	37	86876023480
FG354800GRAY	Gray	Untouchable® Round Funnel Top for FG294700, FG354600 Containers	37	86876023527

PART NO.	Color	DESCRIPTION	PAGE	UPC
FG35500GRAY	Gray	Rigid Liner for FG816088 Container	57	86876023534
FG35500GRAY	Gray	Rigid Liner for FG818488, FG818588 Containers	66	86876023534
FG355200GRAY	Gray	Rigid Liner with Rim for FG817088 Container	57	86876023541
FG355200GRAY	Gray	Rigid Liner with Rim for FG818088 and FG818288 Containers	66	86876023541
FG356300BEIG	Beige	Rigid Liner for FG9P9000 and FG9P9100 Containers	63	86876192568
FG356600GRAY	Gray	Rigid Liner for FG843088	62	86876023657
FG356973BLUE	Blue	Untouchable® Square Recycling Container	37	86876194227
FG356988BEIG	Beige	Untouchable® Square Container	37	86876191431
FG356988BLA	Black	Untouchable® Square Container	37	86876191448
FG356988GRAY	Gray	Untouchable® Square Container	37	86876191424
FG360088WHT	White	Slant-Front Ingredient Bin with Sliding Lid and 32-oz (0.9-L) Scoop	222	86876178142
FG360288WHT	White	Slant-Front Ingredient Bin with Sliding Lid and 32-oz (0.9-L) Scoop	222	86876178159
FG360388WHT	White	Slant-Front Ingredient Bin with Sliding Lid and 32-oz (0.9-L) Scoop	222	86876178166
FG361600WHT	White	Lid for FG369000 Food/Tote Box	226	86876024081
FG362000BLA	Black	Untouchable® Half-Round Lid, with Swing Door for FG352000 Container	37	86876144352
FG364800GRAY	Gray	Lid for FG334900 Bus/Utility Box	241	86876042658
FG369000WHT	White	Food/Tote Box	226	86876025538
FG370612714	Green	4.5- Cu.-Ft. Roughneck Lawn Cart Pallet, Green	186	75608370619
FG370712907	Platinum	3.25-Cu.-Ft. Roughneck Lawn Cart Pallet, Platinum	186	75608370718
FG395800BEIG	Beige	Untouchable® Square Container (liner for FG396500)	62	86876026528
FG395800BEIG	Beige	Untouchable® Square Container (liner for FG396500)	37	86876026528
FG395800BEIG	Beige	Untouchable® Square Container (liner for FG917100/FG917300/FG396500)	37	86876026528
FG395800GRAY	Gray	Untouchable® Square Container (liner for FG396500)	63	86876057553
FG395800GRAY	Gray	Untouchable® Square Container (liner for FG917100/FG917300/FG396500)	37	86876057553
FG395873BLUE	Blue	Square Recycling Container	37	86876194241
FG395900BEIG	Beige	Untouchable® Square Container (liner for FG917500/FG917600)	62	86876026573
FG395900BEIG	Beige	Untouchable® Square Container (liner for FG917500/FG917600)	37	86876026573
FG395900GRAY	Gray	Untouchable® Square Container (liner for FG917500/FG917600)	62	86876057560
FG395900GRAY	Gray	Untouchable® Square Container (liner for FG917500/FG917600)	37	86876057560
FG395973BLUE	Blue	Square Recycling Container	37	86876194258
FG396300BEIG	Beige	Plaza® Container with Tray Top	63	86876156096
FG396300BLA	Black	Plaza® Container with Tray Top	63	86876156409
FG396400BEIG	Beige	Plaza® Container	63	86876147995
FG396400BLA	Black	Plaza® Container	63	86876156447
FG396400DGRN	Dark Green	Plaza® Container	63	86876148008
FG396500BEIG	Beige	Plaza® Container with Ash tray	63	86876148015

PART NO.	Color	DESCRIPTION	PAGE	UPC
FG396600DWOOD	Driftwood	Landmark Series® Classic Container, Ash/Trash Frame with FG356988 Rigid Liner	60	86876039344
FG396600SBLE	Sable	Landmark Series® Classic Container, Ash/Trash Frame with FG356988 Rigid Liner	60	86876039351
FG396700SBLE	Sable	Landmark Series® Classic Container, Funnel Top Frame with FG356988 Rigid Liner	60	86876039375
FG396873BLUE	Blue	Plaza® Bottle and Can Recycling Container	63	86876194357
FG397000BLA	Black	Landmark Series® Classic Container, Dome Top Frame with FG395800 Rigid Liner	60	86876172874
FG397000DWOOD	Driftwood	Landmark Series® Classic Container, Dome Top Frame with FG395800 Rigid Liner	60	86876012989
FG397000SBLE	Sable	Landmark Series® Classic Container, Dome Top Frame with FG395800 Rigid Liner	60	86876013108
FG397001BLA	Black	Landmark Series® Classic Container, Dome Top with Ash Tray, Frame and FG395800 Rigid Liner	60	86876172881
FG397001DWOOD	Driftwood	Landmark Series® Classic Container, Dome Top with Ash Tray, Frame and FG395800 Rigid Liner	60	86876099027
FG397001SBLE	Sable	Landmark Series® Classic Container, Dome Top with Ash Tray, Frame and FG395800 Rigid Liner	60	86876099010
FG397088BLA	Black	Landmark Series® Classic Container, Dome Top Frame with Lock Option, with FG395800 Rigid Liner	60	86876172898
FG397100DWOOD	Driftwood	Landmark Series® Classic Container, Ash/Trash Frame with FG395800 Rigid Liner	60	86876013351
FG397100SBLE	Sable	Landmark Series® Classic Container, Ash/Trash Frame with FG395800 Rigid Liner	60	86876013382
FG397200SBLE	Sable	Landmark Series® Classic Container, Funnel Top Frame with FG395800 Rigid Liner	60	86876029345
FG397500BLA	Black	Landmark Series® Classic Container, Dome Top Frame with FG395900 Rigid Liner	60	86876172904
FG397500BLA	Black	Landmark Series® Classic Container, Dome Top Frame with FG395900 Rigid Liner	52	86876172904
FG397500DWOOD	Driftwood	Landmark Series® Classic Container, Dome Top Frame with FG395900 Rigid Liner	60	86876013467
FG397500DWOOD	Driftwood	Landmark Series® Classic Container, Dome Top Frame with FG395900 Rigid Liner	52	86876013467
FG397500SBLE	Sable	Landmark Series® Classic Container, Dome Top Frame with FG395900 Rigid Liner	60	86876013535
FG397500SBLE	Sable	Landmark Series® Classic Container, Dome Top Frame with FG395900 Rigid Liner	52	86876013535
FG397501BLA	Black	Landmark Series® Classic Container, Dome Top with Ash tray, Frame and FG395900 Rigid Liner	60	86876172911
FG397501BLA	Black	Landmark Series® Classic Container, Dome Top with ash tray, Frame and FG395900 Rigid Liner	52	86876172911
FG397501DWOOD	Driftwood	Landmark Series® Classic Container, Dome Top with ash tray, Frame and FG395900 Rigid Liner	60	86876099041

UTILITY AND RECYCLING REFUSE

DECORATIVE REFUSE

CLEANING

MATERIAL HANDLING

WASHROOM

FOODSERVICE

ACCESSORIES & INDEX



PART NO.	Color	DESCRIPTION	PAGE	UPC
FG397501DWOOD	Driftwood	Landmark Series® Classic Container, Dome Top with ash tray, Frame and FG395900 Rigid Liner	52	86876099041
FG397501SBLE	Sable	Landmark Series® Classic Container, Dome Top with ash tray, Frame and FG395900 Rigid Liner	60	86876099034
FG397501SBLE	Sable	Landmark Series® Classic Container, Dome Top with ash tray, Frame and FG395900 Rigid Liner	52	86876099034
FG397589BLA	Black	Landmark Series® Security Container with Lock and Clear Panels	52	86876173932
FG400055		AutoJanitor® BioFlush® Drain Maintenance Refill	214	763905000550
FG400573		Standard Aerosol — Vanilla Royale	206	763905005739
FG400586		Purinel® SC — Drain Maintainer & Cleaner	214	763905005869
FG400200	CORL, ROCK	20G Landmark Series® Panel for FG396600 and FG396700	60	
FG400300	BSTON, CORL, ROCK	35G Landmark Series® Panel for FG397000, FG397001, FG397088, FG397100, FG397200	60	
FG400400	BSTON, CORL, ROCK	50G Landmark Series® Panel for FG397500, FG397501	60	
FG400600CLR	Clear	Clear Replacement Panel for FG397000, FG397001, FG397088, FG397100, FG397200 Containers	60	86876173840
FG400695	White	Pump LED Dispenser — White	263	763905006958
FG400696		Standard Aerosol — Cinnamon Spice	206	763905006965
FG400700CLR	Clear	Clear Replacement Panel for FG397500, FG397501, FG397589 Containers	61	86876173925
FG400978		AutoJanitor® Cleaner & Deodorizer Refill — Linen Fresh™	214	763905009782
FG400980		AutoJanitor® Cleaner & Deodorizer Refill — Mandarin Orange	214	763905009805
FG400982		AutoJanitor® Cleaner & Deodorizer Refill — Country Delight™	214	763905009829
FG4009831		Standard Aerosol — Linen Fresh™	206	763905009836
FG4009841		Standard Aerosol — Orchard Fields	206	763905009843
FG4009851		Standard Aerosol — Mountain Peaks	206	763905009850
FG400992A		Pump — Linen Fresh™	263	763905009928
FG401088		Digital Receiving Scale	236	86876207934
FG401186A		AutoFlush® Sidemount Polished Chrome Urinal	213	763905011860
FG401187A		AutoFlush® Sidemount Polished Chrome Toilet	213	763905011877
FG401192		Pump — Pure	263	763905011921
FG401206A		AutoFlush® Sidemount Polished Chrome Toilet	213	763905012065
FG401207A		Auto Flush® Sidemount Polished Chrome Urinal	213	
FG401231		Standard Aerosol — Preference Pack	206	763905012317
FG4012441		Microburst® 9000 Refill — Linen Fresh™	204	763905012447
FG4012451		Microburst® 9000 Refill — Orchard Fields	204	763905012454
FG4012461		Microburst® 9000 Refill — Mountain Peaks	204	763905012461
FG4012471		Microburst® 9000 Refill — Ocean Breeze	204	763905012478

PART NO.	Color	DESCRIPTION	PAGE	UPC
FG4012481		Microburst® 9000 Refill — Country Delight™	204	763905012485
FG4012491		Microburst® 9000 Refill — Preference Pack	204	763905012492
FG4012551		Microburst® 3000 Refill — Linen Fresh™	203	763905012553
FG4012561		Microburst® 3000 Refill — Orchard Fields	203	763905012560
FG4012571		Microburst® 3000 Refill — Mountain Peaks	203	763905012577
FG4012581		Microburst® 3000 Refill — Ocean Breeze	203	763905012584
FG4012591		Microburst® 3000 Refill — Country Delight™	203	763905012591
FG401260A		Microburst® 3000 Refill — Preference Pack	203	763905012607
FG401266		Pump — Mountain Spa™	263	763905012669
FG401310	Polished Chrome/Black	OneShot® Liquid Dispenser — Polished Chrome/Black	194	763905013109
FG4013111		Enriched Lotion Hand Soap with Moisturizers	194	763905013116
FG4013131		Green Certified Lotion Soap	194	763905013130
FG401375	White	Microburst® 9000 Economizer Dispenser — White	204	763905013758
FG400868	White	Standard Aerosol Economizer — White	206	763905008686
FG401442	White	Microburst® 3000 Economizer Dispenser — White	203	763905014427
FG401503		Standard Aerosol — Delicious Apple	206	763905015035
FG401504		Standard Aerosol — Mandarin Orange	206	763905015042
FG4015061		Standard Aerosol — Country Delight™	206	763905015066
FG401528	Brushed Chrome/Black	OneShot® Liquid Dispenser — Brushed Chrome/Black	194	763905015288
FG401532		AutoClean® Cleaner & Deodorizer Refill — Mandarin Orange	214	763905015325
FG4015411		Enriched Lotion Hand Soap with Moisturizers	194	763905015417
FG4015431		Green Certified Lotion Soap	194	763905015431
FG401544	Polished Chrome	Manual Liquid Dispenser — Polished Chrome	194	763905015448
FG4015471		Standard Aerosol — Ocean Breeze	206	763905015479
FG401591		AutoClean® Cleaner & Deodorizer Refill — Linen Fresh™	214	763905015912
FG401689		Microburst® 3000 Refill — Cinnamon Spice	259	763905016896
FG401690		Microburst® 3000 Refill — Mango	203	763905016902
FG401691		Microburst® 3000 Refill — Vanilla Royale	203	763905016919
FG401692		Microburst® 9000 Refill — Cinnamon Spice	204	763905016926
FG401693		Microburst® 9000 Refill — Mango	204	763905016933
FG401694		Microburst® 9000 Refill — Vanilla Royale	204	763905016940
FG401695		Standard Aerosol — Mango	206	763905016957
FG401804A		AutoFlush® Clamp Polished Chrome Urinal	213	763905018043
FG401805A		AutoFlush® Clamp Polished Chrome Toilet	213	763905018050
FG401832	Polished Chrome/Black	OneShot® Liquid Dispenser Metal Spout — Polished Chrome/Black	194	763905018326
FG401904A		Pump — Ocean Breeze	263	763905019040
FG401906A		Pump — Country Delight™	263	763905019064
FG401909		Standard Aerosol — Lemon	206	763905019095

PART NO.	Color	DESCRIPTION	PAGE	UPC
FG401981		AutoFlush® Sidemount Polished Chrome Toilet — Metal	213	86876274523
FG401982		AutoFlush® Sidemount Polished Chrome Urinal — Metal	213	86876274530
FG402060A		Auto Flush® Clamp Polished Chrome Urinal - Metal	213	
FG402059A		AutoFlush® Clamp Polished Chrome Toilet — Metal	213	763905020596
FG402073	Polished Chrome	OneShot® Liquid Dispenser — Polished Chrome	194	86876275049
FG402093		Microburst® 9000 Refill — Mandarin Orange	204	763905020930
FG402110		TCell™ Refill — Wakening Spring	207	763905021104
FG402111		TCell™ Refill — Polar Mist	207	763905021111
FG402112		TCell™ Refill — Blue Splash	207	763905021128
FG402113		TCell™ Refill — Citrus	207	763905021135
FG402187		TCell™ Refill — Crystal Breeze	207	763905021876
FG402236		TCell™ Refill Preference Pack	207	763905022361
FG402241	Polished Chrome	OneShot® Liquid Dispenser Low Profile — Polished Chrome	194	763905022415
FG402243	Polished Chrome	OneShot® Liquid Dispenser Low Profile Metal — Polished Chrome	194	763905022439
FG402310	White	Clean Seat Foam 400 mL Dispenser — White	215	763905023108
FG402312		Clean Seat Foaming Refill	215	763905023122
FG402338	White	Sanitary Bin 5 Gallon — White	217	763905023382
FG402339		Sanitary Bin 5 Gallon Liners — 15 per roll	217	763905023399
FG402348		SaniSense Bin Deodorizer™	217	763905023481
FG402354		Microburst® 9000 Refill — Blue Splash	204	763905023542
FG402355		Microburst® 3000 Refill — Blue Splash	203	763905023559
FG402363		Enriched Lotion Free 'N Clean Soap	193	763905023634
FG402364		Enriched Lotion Free 'N Clean Soap	193	763905023641
FG402369		TCell™ Refill — Mango Blossom	207	763905023696
FG402408		Microburst® 3000 Refill — Mandarin Orange	203	763905024082
FG402430		TCell™ Heavy-Duty Dispenser	207	763905024303
FG402470		TCell™ Refill — Cucumber Melon	207	763905024709
FG402472		TCell™ Refill — Tropical Sunrise	207	763905024723
FG402473		TCell™ Refill — Summer Sorbet	207	763905024730
FG402498		TCell™ Refill — Pure™ Odor Neutralizer	207	763905024983
FG402537		Clean Seat Spray Refill	215	763905525374
FG404088		Digital Receiving Scale	236	77177405310
FG409100BLA	Black	Utility Cart, Open-Sided	177	86876148947
FG409100BLA	Black	Utility Cart, Open-Sided	314	86876148947
FG409100GRAY	Gray	Utility Cart, Open-Sided	177	86876145076
FG409100GRAY	Gray	Utility Cart, Open-Sided	314	86876145076
FG409100OWHT	Off-White	Utility Cart, Open-Sided	177	86876133424
FG409100OWHT	Off-White	Utility Cart, Open-Sided	314	86876133424
FG409300BLA	Black	Utility Cart with Enclosed End Panels on 3 Sides	177	86876153729
FG409300WHT	White	Utility Cart with Enclosed End Panels on 3 Sides	177	
FG409300BLA	Black	Utility Cart with Enclosed End Panels on 3 Sides	314	86876153729
FG409400GRAY	Gray	Instrument Cart with Lockable Doors and Sliding Drawers	177	86876145069
FG409500BLA	Black	Equipment Cart	177	86876153750
FG409600BLA	Black	4-Shelf Cart, Open-Sided	177	86876153736

PART NO.	Color	DESCRIPTION	PAGE	UPC
FG421288BLA	Black	Executive Single-Action Basic Mechanical Sweeper	147	86876187373
FG421388BLA	Black	Executive Dual-Action Bristle Mechanical Sweeper	147	86876187380
FG421588BLA	Black	Executive Dual-Action Brushless Mechanical Sweeper	147	86876187397
FG424288BLA	Black	100 U.S. Gallon Stock Tank	185	86876190465
FG424300BLA	Black	50 U.S. Gallon Stock Tank	185	86876186024
FG424700BLA	Black	300 U.S. Gallon Stock Tank	185	86876186055
FG424806BLA	Black	Stock Tank Float Valve	185	86876186062
FG425100YEL	Yellow	Over-the-Spill® Station Kit includes, Pad Dispenser, 25 Large Pads, and Fasteners	157	86876162486
FG425200YEL	Yellow	Over-the-Spill® Station Pads, Large; Refill Pads for FG425100, Contains 25 Pads	157	86876162493
FG425300YEL	Yellow	Over-the-Spill® Station Pads, Medium; Refill Pads for FG425100, Contains 25 Pads	157	86876162509
FG425400YEL	Yellow	Over-the-Spill® Pad Tablet, Contains 25 Pads	157	86876162516
FG425500YEL	Yellow	Over-the-Spill® Mini Tablet, Contains 22 Pads	157	86876193589
FG430000BLA	Black	Convertible Utility Cart	175	86876191523
FG430000BLA	Black	Convertible Utility Cart	312	86876191523
FG440000BLA	Black	Triple® Trolley, Utility-Duty with Straight Handle and 3" (7.6 cm) Casters	179	86876172997
FG440100BLA	Black	Triple® Trolley, Standard Duty with User-Friendly Handle and 5" dia x .875" w (12.7 cm x 2.22 cm) Casters	179	86876172980
FG440300BLA	Black	Heavy-Duty Platform Truck	179	86876184433
FG440300BLA	Black	Heavy-Duty Platform Truck (Sm 24" x 36")	315	86876184433
FG440600BLA	Black	Heavy-Duty Platform Truck	179	86876184440
FG443600BLA	Black	Heavy-Duty Platform Truck	179	86876184464
FG443600BLA	Black	Heavy-Duty Platform Truck (Med 24" x 48")	315	86876184464
FG443610BLA	Black	Heavy-Duty Platform Truck	179	86876184488
FG444100BLA	Black	Heavy-Duty Platform Truck	179	86876184501
FG446300BLA	Black	A-Frame Panel Truck (24" x 48")	180	86876202526
FG446600BLA	Black	Heavy-Duty Platform Truck	179	86876184532
FG446610BLA	Black	Heavy-Duty Platform Truck	179	86876184556
FG446800BLA	Black	Sheet and Panel Truck (24" x 48")	180	86876202557
FG447100BLA	Black	Heavy-Duty Platform Truck	179	86876184570
FG447700BLA	Black	5th Wheel Wagon Truck (24" x 48")	179	86876202625
FG448600BLA	Black	Side-Panel Platform Truck (24" x 48")	181	86876202687
FG450007	White	Spray Dispenser 800 mL — White	207	763905500074
FG450008	White	Clean Seat Soap Spray 400 mL Dispenser — White	215	763905500081
FG450009		Spray Hand Soap with Moisturizers	207	763905500098
FG450011		Spray Hand Soap with Moisturizers	207	763905500111
FG450017	White	Foam Skin Care Dispenser 800 mL — White	198	763905500173
FG450019		Foam Hand Soap with Moisturizers	198	763905000192
FG450030		Spray Moisturizing Hand Sanitizer — E3	255	763905500302
FG450034	Black	Foam Skin Care Dispenser 800 mL — Black	198	763905500340
FG450088BEIG	Beige	Ergo Handle Utility Cart (Med)	173	86876169188
FG450088BEIG	Beige	HD 2-Shelf Utility Cart w/ Lipped Shelf (Small)	314	86876169188
FG450088BLA	Black	Ergo Handle Utility Cart (Med)	173	86876184259
FG450088BLA	Black	HD 2-Shelf Utility Cart w/ Lipped Shelf (Small)	314	86876184259



UTILITY AND RECYCLING REFUSE

DECORATIVE REFUSE

CLEANING

MATERIAL HANDLING

WASHROOM

FOODSERVICE

ACCESSORIES & INDEX

PART NO.	Color	DESCRIPTION	PAGE	UPC
FG450089BEIG	Beige	Flat Handle Utility Cart (Small)	173	86876204803
FG450089BLA	Black	Flat Handle Utility Cart (Small)	173	86876204797
FG450500BEIG	Beige	Ergo Handle Utility Cart (Small)	173	86876125078
FG450500BEIG	Beige	HD 2-Shelf Utility Cart Flat Shelf (Small)	314	86876125078
FG450500BLA	Black	Ergo Handle Utility Cart (Small)	173	86876184372
FG450500BLA	Black	HD 2-Shelf Utility Cart Flat Shelf (Small)	314	86876184372
FG450589BLA	Black	Flat Handle Utility Cart (Small)	173	86876204902
FG451288BLA	Black	TradeMaster® Cart with 2-Door Cabinet, Small	175	86876175936
FG451388BLA	Black	TradeMaster® Cart with 4 Drawers	175	86876175943
FG452010BLA	Black	Ergo Handle Utility Cart (Med) with Pneumatic Casters	173	86876184297
FG452088BEIG	Beige	Ergo Handle Utility Cart (Med)	173	86876169201
FG452088BEIG	Beige	HD 2-Shelf Utility Cart w/ Lipped Shelf (Med)	314	86876169201
FG452088BLA	Black	Ergo Handle Utility Cart (Med)	173	86876184280
FG452088BLA	Black	HD 2-Shelf Utility Cart w/ Lipped Shelf (Med)	314	86876184280
FG452089BEIG	Beige	Flat Handle Utility Cart (Med)	173	86876204827
FG452089BLA	Black	Flat Handle Utility Cart (Med)	173	86876204810
FG452500BEIG	Beige	Ergo Handle Utility Cart (Med)	173	86876125092
FG452500BEIG	Beige	HD 2-Shelf Utility Cart Flat Shelf (Med)	314	86876125092
FG452500BLA	Black	Ergo Handle Utility Cart (Med)	173	86876184389
FG452500BLA	Black	HD 2-Shelf Utility Cart Flat Shelf (Med)	314	86876184389
FG452589BLA	Black	Flat Handle Utility Cart (Med)	173	86876204926
FG453388BLA	Black	TradeMaster® Cart with 4 Drawers and Cabinet, Small	175	86876175967
FG454500BLA	Black	Ergo Handle Utility Cart (Large)	173	86876202915
FG454600BLA	Black	Ergo Handle Utility Cart (Large)	173	86876184327
FG454610BLA	Black	Ergo Handle Utility Cart (Large) with Pneumatic Casters	173	86876184334
FG4592000000		8" Replacement Caster Set	223	86876169409
FG4592000000		8" (20.3 cm) Pneumatic Caster Kit	173	86876169409
FG459300	Red	Extension Drawer	173	
FG460800BLA	Black	Cube Truck	168	86876183986
FG460900BLA	Black	Lid for 8 ft. ³ Cube Trucks	168	86876184051
FG4610000000		Spring Kit for FG461100, FG461400 Trucks	168	86876155440
FG461100BLA	Black	Spring Platform Truck	168	86876184013
FG461200BLA	Black	Cube Truck	168	86876183993
FG461200DBLUE	Dark Blue	Cube Truck	168	86876157307
FG461300BLA	Black	Lid for 12 ft. ³ Cube Trucks	168	86876184068
FG461400BLA	Black	Cube Truck	168	86876184006
FG461500BLA	Black	Lid for 14 ft. ³ Cube Trucks	168	86876184075
FG461500BLA	Black	Lid for 16 ft. ³ Cube Trucks	168	86876184075
FG461600BLA	Black	Cube Truck	168	86876184020
FG461673BLUE	Blue	Recycling Cube Truck	168	86876194319
FG461700BLA	Black	Lid for 20 ft. ³ Cube Trucks	168	86876184082
FG461800BLA	Black	Spring Platform Truck	168	86876184044
FG461900BLA	Black	Cube Truck	168	86876184037
FG470800BLA	Black	Utility Truck, Heavy-Duty with 4" dia (10.2 cm) Casters	168	86876184099
FG471200BLA	Black	Utility Truck, Heavy-Duty with 4" dia (10.2 cm) Casters	168	86876184105
FG471600BLA	Black	Utility Truck, Heavy-Duty with 5" dia (12.7 cm) Casters	168	86876184112
FG472000BLA	Black	Utility Truck, Heavy-Duty with 5" dia (12.7 cm) Casters	168	86876184129
FG472600BLA	Black	Lid for 27 ft. ³ Cube Trucks	168	86876184150
FG472700BLA	Black	Utility Truck, Heavy-Duty with 5" dia (12.7 cm) Corner Casters	168	86876184136
FG472741BLA	Black	Towable Utility Truck, Heavy-Duty	168	86876184143
FG4870001	White/Grey Pearl	Microburst® Duet Dispenser White/Grey Pearl	205	763905700016

PART NO.	Color	DESCRIPTION	PAGE	UPC
FG4870002	Black/Black Pearl	Microburst® Duet Dispenser Black/Black Pearl	205	763905700023
FG4870055	Black/Chrome	Microburst® Duet Dispenser Black/Chrome	205	763905700559
FG4870056	White/White	Microburst® Duet Dispenser White/White	205	763905700566
FG4870465	Polished Chrome	OneShot® Foam Dispenser Low Profile Metal — Polished Chrome	193	763905704656
FG500288CLR	Clear	295200, 295500, 295600, 614200	43	86876153569
FG500388CLR	Clear	261000, 294700, 295700, 307120	43	86876153576
FG500394		OneShot® 800 mL Starter Kit (Chrome/Black Dispenser, Hand Wash Refill, 4 D Batteries)	194	763905003940
FG500409		AutoClean® LED Dispenser — Chrome (Kit w/ 3/4" Connector)	214	763905004091
FG500410		AutoClean® LED Dispenser — Chrome (Kit w/ 1 1/2" Connector)	214	763905004107
FG500449		OneShot® 1600 mL Starter Kit (Chrome/Black Dispenser, Hand Wash Refill, 4 D Batteries)	194	763905004497
FG500476		AutoClean® Service Dispenser — Chrome (Kit w/ 3/4" Connector)	214	86876280883
FG500488GRAY	Gray	354600, 816088, 818488, 818588, 614300, 614400, 617700	43	86876153583
FG500588GRAY	Gray	352000, 356800, 356900, 782200, 782300, 817088, 818088, 818288, 818588	43	86876153590
FG500688GRAY	Gray	262000, 614687	43	86876153606
FG500788GRAY	Gray	263200, 263400, 263246, 263256	43	86876155884
FG500888CLR	Clear	264100, 264300, 395800, 395900, 905800, 9P9000, 264346, 264356, 9P9100, 965100, 965200	43	86876155914
FG500988GRAY	Gray	354000, 354100, 396600, 396700, 614500, 614600, 818288, 355400, 354220	43	86876155921
FG501088GRAY	Gray	50-Gal (208.2-L) Drum	43	86876155938
FG501188GRAY	Gray	265500	43	86876155945
FG501388CLR	Clear	256B00, 256B06, 9W2700, 9W2706	43	86876155969
FG501388GRAY	Gray	256B00, 256B06, 9W2700, 9W2706	43	86876155952
FG501688GRAY	Gray	351700, 352600, 396300, 396400, 396500, 396800, 396900, 397000, 397100, 397200, 397500, 843000, 917100, 917200, 917300	43	86876155976
FG502888GRAY	Gray	50-Gallon (189.3-L) Container 9W2700, 9W2706	43	86876155983
FG505012		Stock Tank Drain Plug Kit	185	71691147305
FG507900CLR	Clear	High-Density Coreless Roll Can Liners	43	86876145649
FG511400WHT	Off-White	SeBreeze® Adjustable Fan Dispenser	263	86876126082
FG564200BLA	Black	7.5-Cu.-Ft. Big Wheel® Cart	186	86876185904
FG564210BLA	Black	7.5-Cu.-Ft. Heavy-Duty Big Wheel® Cart	186	86876185430
FG565461BLA	Black	3.5-Cu.-Ft. Big Wheel® Cart (Unassembled)	186	86876185454
FG571473	Blue	14-Gallon Recycling Box	41	
FG571473	Green	14-Gallon Recycling Box	41	
FG571873	Blue	18-Gallon Recycling Box	41	
FG571873	Green	18-Gallon Recycling Box	41	
FG572000WHT	White	Round Storage Container	229	86876131222
FG572024CLR	Clear	Round Storage Container	229	86876131239
FG572100WHT	White	Round Storage Container	229	86876131246
FG572124CLR	Clear	Round Storage Container	229	86876131253

PART NO.	Color	DESCRIPTION	PAGE	UPC
FG572200YEL	Yellow	Color-Coded Round Container Lid	229	86876131260
FG572500YEL	Yellow	Color-Coded Round Container Lid	229	86876131314
FG572200YEL	Yellow	Lid for FG572000, FG572024, FG572100, FG572124 Round Storage Containers	229	86876131260
FG572300WHT	White	Round Storage Container	229	86876131277
FG572324CLR	Clear	Round Storage Container	229	86876131284
FG572400WHT	White	Round Storage Container	229	86876131291
FG572424CLR	Clear	Round Storage Container	229	86876131307
FG572500YEL	Yellow	Lid for FG572300, FG572324, FG572400, FG572424 Round Storage Containers	229	86876131314
FG573000YEL	Yellow	Color-Coded Round Container Lid	229	86876131406
FG572600WHT	White	Round Storage Container	229	86876131321
FG572624CLR	Clear	Round Storage Container	229	86876131338
FG572700WHT	White	Round Storage Container	229	86876131345
FG572724CLR	Clear	Round Storage Container	229	86876131352
FG572800WHT	White	Round Storage Container	229	86876131369
FG572824CLR	Clear	Round Storage Container	229	86876131376
FG572900WHT	White	Round Storage Container with Bail	229	86876131383
FG572924CLR	Clear	Round Storage Container with Bail	229	86876131390
FG573000YEL	Yellow	Lid for FG572600, FG572624, FG572700, FG572724, FG572800, FG572824, FG572900, FG572924 Round Storage Containers	229	86876131406
FG605SRW		Dishwasher-Safe Mechanical Portion Control Scale	235	77177404863
FG611000YEL	Yellow	Hanging Safety Sign with Multilingual "Caution" Imprint and Falling Person Symbol	154	86876159677
FG611200YEL	Yellow	Floor Sign with Multilingual "Caution" Imprint, 2-Sided	155	86876032994
FG611277YEL	Yellow	Floor Sign with "Caution Wet Floor" Imprint, 2-Sided	155	86876141702
FG611278YEL	Yellow	Floor Sign with Multilingual "Closed" Imprint, 2-sided	155	86876123470
FG611400YEL	Yellow	Floor Sign with Multilingual "Caution" Imprint, 4-Sided	155	86876123517
FG611477YEL	Yellow	Floor Sign with "Caution Wet Floor" Imprint, 4-Sided	155	86876141719
FG611478YEL	Yellow	Floor Sign with Multilingual "Closed" Imprint, 4-Sided	155	86876123531
FG612788BLU	Blue	Side-Press Wringer for WaveBrake® Mop Bucket	97	86876176605
FG612788BRN	Brown	Side-Press Wringer for WaveBrake® Mop Bucket	97	86876178258
FG612788GRN	Green	Side-Press Wringer for WaveBrake® Mop Bucket	97	86876176599
FG612788RED	Red	Side-Press Wringer for WaveBrake® Mop Bucket	97	86876176582
FG612788YEL	Yellow	Side-Press Wringer for WaveBrake® Mop Bucket	97	86876176575
FG614000WHT	White	Sanitary Napkin Receptacle with Rigid Liner	217	86876034165
FG6141000000		Waxed Bags for Sanitary Napkin Receptacle	217	
FG614300	Beige	8G Resin Step-On	36	
FG614300	Red	8G Resin Step-On	36	
FG614300	Black	8G Resin Step-On	36	
FG614400	Beige	12G Resin Step-On	36	
FG614400	Red	12G Resin Step-On	36	
FG614400	White	12G Resin Step-On	36	
FG614500	Beige	18G Resin Step-On	36	
FG614500	Red	182G Resin Step-On	36	
FG614500	White	18G Resin Step-On	36	
FG614600	Beige	23G Resin Step-On	36	
FG614600	Red	23G Resin Step-On	36	

PART NO.	Color	DESCRIPTION	PAGE	UPC
FG614600	White	23G Resin Step-On	36	
FG6162000000		Dual Waste Wire Bag Holder	144	86876203912
FG6163000000		Single Waste Wire Bag Holder	144	86876203905
FG617388BLA	Black	Janitorial Cleaning Cart – Traditional	139	86876192292
FG617388BLU	Blue	Janitorial Cleaning Cart – Traditional	139	86876193176
FG617900BLA	Black	Executive Cart Waste/Bag Lid with Storage – High-Capacity	139	86876180749
FG617900BLA	Black	Executive Cart Waste/Bag Lid with Storage – High-Capacity	140	86876180749
FG618000BLA	Black	Trades Cart with 5" (12.7 cm) Casters includes 2 parts boxes and 4 parts bins	174	86876184419
FG618088BLA	Black	Trades Cart with Locking Cabinet includes 2 parts boxes and 4 parts bins	174	86876184426
FG618100YEL	Yellow	Locking Cabinet Doors	140	86876149630
FG618100YEL	Yellow	Locking Cabinet Doors	140	86876149630
FG618400YEL	Yellow	20' (6.1 m) Barrier Chain for FG611400 and Safety Cones	155	86876130508
FG618400YEL	Yellow	20' (50.8 cm) Barrier Chain for G611400 and Safety Cones	156	86876130508
FG618688YEL	Yellow	44 qt WaveBrake® Side-Press Bucket and Wringer with Drain	96	86876191578
FG618900BLA	Black	Executive Full-Size Housekeeping Cart – Traditional	142	86876192407
FG619000BLA	Black	Executive Compact Housekeeping Cart – Traditional	142	86876192414
FG619100BLA	Black	Executive Full-Size Housekeeping Cart with Doors – Traditional	142	86876192421
FG619200BLA	Black	Executive Compact Housekeeping Cart with Doors – Traditional	142	86876192438
FG619400STL	Steel	Pail and Mop Strainer Combination	117	86876167528
FG619500BLA	Black	Executive Adjustable Shelf Kit for Traditional Housekeeping Carts	144	86876192452
FG619500PLAT	Platinum	Executive Adjustable Shelf Kit for Traditional Housekeeping Carts	144	86876162325
FG619600BLA	Black	Executive Glass Rack for Traditional Housekeeping Carts	144	86876192469
FG619600PLAT	Platinum	Executive Glass Rack for Traditional Housekeeping Carts	144	86876162349
FG619700BLA	Black	Executive Locking Door Kit for Traditional Housekeeping Carts	144	86876192476
FG619900BLA	Black	Executive Locking Utility Drawer – Traditional	144	86876192483
FG627600YEL	Yellow	Safety Cone 36" (91.4 cm) with Multilingual "Caution" Imprint	156	86876162660
FG627677YEL	Yellow	Safety Cone 36" (91.4 cm) with Multilingual "Caution Wet Floor" Imprint	156	86876162677
FG627687YEL	Yellow	Safety Cone 36" (91.4 cm) with Multilingual "Caution Safety First" Imprint	156	86876162684
FG627700YEL	Yellow	Safety Cone 25.75" (65.4 cm) with Multilingual "Caution" Imprint	156	86876162622
FG627777YEL	Yellow	Safety Cone 25.75" (65.4 cm) with Multilingual "Caution Wet Floor" Imprint	156	86876162639
FG628400BLA	Black	Weight Ring – Single for all 36" (91.4 cm) Safety Cones	66	86876162745
FG628400BLA	Black	Weight Ring	156	86876162745
FG628700YEL	Yellow	Cone Barricade System Consists of FG627600, (1) Belt Cassette, and (1) Double Weight Ring	156	86876162738

UTILITY AND RECYCLING REFUSE

DECORATIVE REFUSE

CLEANING

MATERIAL HANDLING

WASHROOM

FOODSERVICE

ACCESSORIES & INDEX



PART NO.	Color	DESCRIPTION	PAGE	UPC
FG628700YEL	Yellow	Cone Barricade System Consists of FG627600, (1) Belt Cassette, and (1) Double Weight Ring	157	86876162738
FG630200CLR	Clear	Space-Saving Square Container	228	86876043983
FG630400CLR	Clear	Space-Saving Square Container	228	86876043990
FG630600CLR	Clear	Space-Saving Square Container	228	86876044003
FG630800CLR	Clear	Space-Saving Square Container	228	86876044010
FG631000WHT	White	Toilet Bowl Brush, Plastic Handle, Polypropylene Fill	132	86876007213
FG631100WHT	White	Toilet Bowl Brush Holder, fits FG631000 Brush	132	86876007220
FG631200CLR	Clear	Space-Saving Square Container	228	86876044027
FG631800CLR	Clear	Space-Saving Square Container	228	86876044034
FG632000BRN	Brown	Toilet Bowl Brush, Plastic Handle, Polypropylene Fill	132	86876007312
FG632200CLR	Clear	Space-Saving Square Container	228	86876044041
FG632SRW		Dishwasher-Safe Mechanical Portion Control Scale	235	77177404856
FG633700BLUE	Blue	Floor Scrub, Plastic Block, Bi-level, Polypropylene Fill	131	86876141993
FG634100BLA	Black	Plastic Block Counter Brush, Tampico Fill with 8" (20.3 cm) Bristle Coverage	132	86876142013
FG634200SILV	Silver	Plastic Block Counter Brush, Flagged Polypropylene Fill with 8" (20.3 cm) Bristle Coverage	132	86876142020
FG635100LAC	Lacquer	Wood Handle, Threaded, Lacquered	128	86876007527
FG635200NAT	Natural	Wood Handle, Tapered, Sanded	128	86876007534
FG635500GRAY	Gray	Aluminum Handle, Threaded Plastic Tip, Vinyl Grip	128	86876007572
FG635700BLA	Black	Super Self-Locking Wood Handle, Threaded Metal Tip	128	86876128659
FG636100LAC	Lacquer	Wood Handle, Threaded, Lacquered	128	86876007596
FG636200NAT	Natural	Wood Handle, Tapered, Sanded	128	86876007602
FG636400LAC	Lacquer	Wood Handle, Threaded Metal Tip, Lacquered	128	86876007640
FG637300BRN	Brown	Lobby Broom, 100% Corn Fill	129	
FG637400BLA	Black	Executive Lobby Broom w/ Vinyl Handle	129	86876154962
FG637500GRAY	Gray	Broom, 1" dia (2.5 cm) Vinyl- Coated Metal Handle, Flagged Polypropylene Fill	129	86876142129
FG638300BLUE	Blue	Corn Broom, Warehouse, 1.13" dia (2.9 cm) Stained/Lacquered Handle	129	86876007824
FG638400ORAN	Orange	Corn Broom, Warehouse, 1.13" dia (2.9 cm) Stained/Lacquered Handle	129	86876007855
FG638500GRAY	Gray	Broom, 1" dia (2.5 cm) Metal Handle, Flagged Polypropylene Fill	129	86876142167
FG638906BLA	Black	Jumbo Smooth Sweep Angle Broom, 17/8" dia (4.76 cm) Black Metal Handle, Polypropylene Fill	129	86876194081
FG639700GRAY	Gray	Broom Replacement Head, Thread fits FG635100, FG635500 Handles	129	86876153514
FG643500BRNZ	Bronze	Steel Sponge Mop with Cellulose Head	117	86876034790
FG643600YEL	Yellow	Steel Cellulose Replacement Head	117	86876034806
FG648200COBLT	Cobalt	Iron Handle Scrub Brush, Polypropylene Fill	131	86876160499
FG650900WHT	White	Color-Coded Square Container Lid	228	86876044102
FG652300WHT	White	Color-Coded Square Container Lid	228	86876044140

PART NO.	Color	DESCRIPTION	PAGE	UPC
FG652300WHT	White	Lid for FG631200, FG631800, FG632200, FG9F0700, FG9F0800, FG9F0900 Space-Saving Containers	228	86876044140
FG738000YEL	Yellow	Tandem™ 31-Qt Bucket and Wringer Combo	97	86876188233
FG748000YEL	Yellow	26 qt WaveBrake® Side-Press Bucket and Wringer	95	86876184839
FG750112		Enriched Foam Hand Soap with Moisturizers	191	763905501125
FG750127	Black/Black Pearl	AutoFoam Dispenser — Black/Black Pearl	195	763905501279
FG750138	White/Black Pearl	AutoFoam Dispenser — White/Black Pearl	195	763905501385
FG750139	Black/Grey Pearl	AutoFoam Dispenser — Black/Grey Pearl	195	763905501392
FG750140	White/Grey Pearl	AutoFoam Dispenser — White/Grey Pearl	195	763905501408
FG750176	Metallic	Manual Spray Dispenser 400 mL — Metallic	255	763905501767
FG750243	White	Sanitary Bin 3 Gallon — White	217	86876283525
FG750244	Gray	Sanitary Bin 3 Gallon — Gray	217	86876283532
FG750354	Polished Chrome	Venetian 5.5" in Polished Chrome	211	763905503549
FG750355	Polished Chrome	Venetian 5.5" Polished Chrome	211	763905503556
FG750362		Microburst® 3000 Refill — Green Tea	203	763905503624
FG750363		Microburst® 3000 Refill — Cucumber Melon	203	763905503631
FG750366		Microburst® 9000 Refill — Cucumber Melon	204	763905503662
FG750386		Enriched Foam Hand Soap with Moisturizers	193	763905503860
FG750389		Enriched Foam Free 'N Clean Soap — E1	193	763905503891
FG750390		Enriched Foam Free 'N Clean Soap — E1	193	763905503907
FG750411	Black/Chrome	AutoFoam Dispenser — Black/Chrome	195	763905504119
FG750443		Sanitary Bin 3 Gallon Liners — 15 per roll	217	86876284317
FG750517		Enriched Foam Hand Soap with Moisturizers	193	763905505178
FG750537		TCell™ Refill — Sugar Cookie	267	763905505376
FG750590		Foam Alcohol Hand Sanitizer	254	763905505901
FG750591		Enriched Foam Alcohol Hand Sanitizer — E3	253	763905505918
FG750592		Foam Alcohol-Free Hand Sanitizer	198	763905505925
FG750593		Enriched Foam Alcohol-Free Hand Sanitizer	191	763905505932
FG750824	Black	Hand Sanitizer Station (Metal Stand) — Black	203	86876205749
FG750905		TCell™ Refill — Vanilla Crème	207	763905509053
FG750907		TCell™ Refill — Cinnamon Spice	207	763905509077
FG751001		Foam Hair & Body Wash	198	763905510011
FG757088YEL	Yellow	WaveBrake® Bucket	96	86876176537
FG757579YEL	Yellow	Down-Press Wringer for WaveBrake® Bucket	95	86876203172
FG757588BLUE	Blue	Down-Press Wringer for WaveBrake® Bucket	95	86876179354
FG757588BRN	Brown	Down-Press Wringer for WaveBrake® Bucket	95	86876179248
FG757588YEL	Yellow	Down-Press Wringer for WaveBrake® Bucket	95	86876179231
FG757688YEL	Yellow	WaveBrake® 44-Qt Down-Press Combo	95	86876191585
FG757788BRN	Brown	WaveBrake® Down-Press Combo	95	86876179170
FG757788YEL	Yellow	WaveBrake® Down-Press Combo	95	86876179156

PART NO.	Color	DESCRIPTION	PAGE	UPC
FG757888BLUE	Blue	WaveBrake® Down-Press Combo	95	86876179293
FG757888GRN	Green	WaveBrake® Down-Press Combo	95	86876179286
FG757888RED	Red	WaveBrake® Down-Press Combo	95	86876179279
FG757900BRN	Brown	WaveBrake® Down-Press Institutional Combo	95	
FG758088BRN	Brown	35 qt WaveBrake® Side-Press Bucket and Wringer	95	86876176513
FG758088YEL	Yellow	35 qt WaveBrake® Side-Press Bucket and Wringer	95	86876176421
FG758888BLUE	Blue	35 qt WaveBrake® Side-Press Bucket and Wringer	95	86876176506
FG758888GRN	Green	35 qt WaveBrake® Side-Press Bucket and Wringer	95	86876176490
FG758888RED	Red	35 qt WaveBrake® Side-Press Bucket and Wringer	95	86876176483
FG759088YEL	Yellow	35 qt WaveBrake® Institutional Bucket and Sieve Wringer	96	86876179187
FG773488BLA	Black	5-Drawer Mobile Work Center	174	86876160031
FG780508BLA	Black	Sturdy Chair™ Youth Seat with Wheels	242	86876204704
FG780508DGRN	Dark Green	Sturdy Chair™ Youth Seat with Wheels	242	86876204728
FG780508PLAT	Platinum	Sturdy Chair™ Youth Seat with Wheels	242	86876204711
FG780608BLA	Black	Sturdy Chair™ Youth Seat without Wheels	242	86876204735
FG780608DGRN	Dark Green	Sturdy Chair™ Youth Seat without Wheels	242	86876204759
FG780608PLAT	Platinum	Sturdy Chair™ Youth Seat without Wheels	242	86876204742
FG781408BLA	Black	Sturdy Chair™ Youth Seat, RTA (ready to assemble), No Wheels	242	86876204766
FG781408DGRN	Dark Green	Sturdy Chair™ Youth Seat, RTA (ready to assemble), No Wheels	242	86876204780
FG781408PLAT	Platinum	Sturdy Chair™ Youth Seat, RTA (ready to assemble), No Wheels	242	86876204773
FG781588BLA	Black	Tray for FG780508, FG780608, and FG781408 Chairs	242	86876193831
FG781588DGRN	Dark Green	Tray for FG780508, FG780608, and FG781408 Chairs	242	86876188158
FG781588PLAT	Platinum	Tray for FG780508, FG780608, and FG781408 Chairs	242	86876188127
FG781588RED	Red	Tray for FG780508, FG780608, and FG781408 Chairs	242	86876188134
FG781788WHT	White	Protective Liners for Baby Changing Stations, Laminated 2-Ply Tissue Paper	216	86876193657
FG781888LPLAT	Light Platinum	Baby Changing Station Horizontal	216	86876192582
FG781988LPLAT	Light Platinum	Baby Changing Station Vertical	216	86876192599
FG782200BEIG	Beige	Slim Jim® Wall-Mounted Container	40	86876125511
FG782200BRN	Brown	Slim Jim® Wall-Mounted Container	40	86876125535
FG810W		Washable Mechanical Portion Control Scale	235	77177404702
FG816088BEIG	Beige	Marshal® Classic Container	57	86876157017
FG816088BLA	Black	Marshal® Classic Container	57	86876157024
FG816088BRN	Brown	Marshal® Classic Container	57	86876157031
FG816088OWHT	Off-White	Marshal® Classic Container	57	86876157048
FG817088BEIG	Beige	Marshal® Classic Container	57	86876156881
FG817088BLA	Black	Marshal® Classic Container	57	86876156898
FG817088BRN	Brown	Marshal® Classic Container	57	86876156904
FG817088OWHT	Off-White	Marshal® Classic Container	57	86876156911
FG818088BEIG	Beige	Ash/Trash Classic Container with Doors	66	86876156935
FG818088BRN	Brown	Ash/Trash Classic Container with Doors	66	86876156959
FG818288BEIG	Beige	Ash/Trash Classic Container without Doors	66	86876156973

PART NO.	Color	DESCRIPTION	PAGE	UPC
FG818488BEIG	Beige	Ash/Trash Classic Container with Doors	66	86876157062
FG818588BEIG	Beige	Ash/Trash Classic Container without Doors	66	86876184990
FG820BW		Washable Mechanical Portion Control Scale	235	77177404719
FG8315ASWHT	White	Measuring Cup Set	232	71691005063
FG8316ASWHT	White	Measuring Spoon Set	232	71691831631
FG832W		Washable Mechanical Portion Control Scale	235	77177404764
FG832WQ		Washable Mechanical Portion Control Scale w/ QuickStop	235	77177404757
FG840W		Washable Mechanical Portion Control Scale	235	77177404665
FG843088BEIG	Beige	35-Gallon Ranger® Container	62	86876187243
FG843088BLA	Black	35-Gallon Ranger® Container	62	86876187960
FG905800BLA	Black	Atrium® Classic Container with Funnel Top	59	86876156379
FG905886WGRAN	White Granite	Atrium® Classic Container with Funnel Top	59	86876162820
FG917188BEIG	Beige	45-Gallon Ranger® Container with 2 Doors	62	86876187267
FG917188BLA	Black	45-Gallon Ranger® Container with 2 Doors	62	86876187250
FG917388BEIG	Beige	45-Gallon Ranger® Container with 4 Openings	62	86876187281
FG917388BLA	Black	45-Gallon Ranger® Container with 4 Openings	62	86876187274
FG917500BEIG	Beige	65-Gallon Ranger® Container with 2 Doors	62	86876187304
FG917500BLA	Black	65-Gallon Ranger® Container with 2 Doors	62	86876187298
FG917600BEIG	Beige	65-Gallon Ranger® Container with 4 Openings	62	86876187328
FG917600BLA	Black	65-Gallon Ranger® Container with 4 Openings	62	86876187311
FG917700BEIG	Beige	Weighted Base Accessory for 45- and 65-Gallon Ranger® Containers	62	86876187342
FG917700BLA	Black	Weighted Base Accessory for 45- and 65-Gallon Ranger® Containers	62	86876187335
FG9B2200BRN	Brown	Plastic Foam Block, Medium Floor Sweep, Tampico Fill	128	86876164091
FG9B2900YEL	Yellow	Short Plastic-Handle Utility Brush, Synthetic Fill	130	86876164169
FG9B3200YEL	Yellow	Long Plastic-Handle Utility Brush, Synthetic Fill	130	86876164190
FG9B3400BRN	Brown	Deck Brush, Plastic Block, Palmyra Fill	131	86876164213
FG9B3600YEL	Yellow	Deck Brush, Plastic Block, Polypropylene Fill	131	86876164237
FG9B3700GRAY	Gray	Wash Brush, Plastic Block, Flagged Polystyrene Fill	131	86876164244
FG9B4400GRAY	Gray	Wire Brush with Scraper, Long Plastic Handle	131	86876164329
FG9B5500YEL	Yellow	Corn Whisk Broom	129	86876164411
FG9B5600BLA	Black	Tile and Grout Brush, Plastic Bristles	131	86876164428
FG9B57000000		Tile and Grout Brush, Brass Bristles	131	86876164435
FG9B5900BLA	Black	Extra-Large Dust Pan	132	86876164459
FG9B6000BLA	Black	Jumbo Dust Pan	132	86876164466
FG9B7200GRN	Green	Wash Brush, Plastic Block, Nylon Fill	131	86876164251
FG9C03060000		Executive Spray Bottle, 32-oz. 30"-42" (76.2 cm-106.6 cm) Lambswool Duster with Telescoping Plastic Handle	149	86876180053
FG9C04000000			125	86876169102
FG9C2600BLA	Black	18" (45.7 cm) Standard Floor Squeegee	133	86876170450
FG9C2700BLA	Black	22" (55.9 cm) Standard Floor Squeegee	133	86876170467

UTILITY AND RECYCLING REFUSE

DECORATIVE REFUSE

CLEANING

MATERIAL HANDLING

WASHROOM

FOODSERVICE

ACCESSORIES & INDEX



UTILITY AND
RECYCLING REFUSE

DECORATIVE REFUSE

CLEANING

MATERIAL HANDLING

WASHROOM

FOODSERVICE

ACCESSORIES
& INDEX

PART NO.	Color	DESCRIPTION	PAGE	UPC
FG9C2800BLA	Black	22" (55.9 cm) Heavy-Duty Floor Squeegee	133	86876170474
FG9C2900BLA	Black	30" (76.2 cm) Heavy-Duty Floor Squeegee	133	86876170481
FG9C3100BLA	Black	18" (45.7 cm) Straight Floor Squeegee	133	86876170702
FG9C3200BLA	Black	24" (61 cm) Straight Floor Squeegee	133	86876170719
FG9C3300BLA	Black	36" (91.4 cm) Straight Floor Squeegee	133	86876170726
FG9C3400BLA	Black	24" (61 cm) Curved Floor Squeegee	133	86876170733
FG9C3500BLA	Black	18" (45.7 cm) Replacement Blade for FG9C3100	133	86876170740
FG9C3600BLA	Black	24" (61 cm) Replacement Blade for FG9C3200	133	86876170757
FG9C3700BLA	Black	36" (91.4 cm) Replacement Blade for FG9C3300	133	86876170764
FG9C4100BLA	Black	18" (45.7 cm) Plastic Professional Squeegee with Black Dual Moss Rubber	133	86876170672
FG9C4200BLA	Black	18" (45.7 cm) Plastic Scrub and Dry Squeegee with Black Dual Moss Rubber	133	86876170818
FG9C7400RED	Red	Dirty Water Bucket for WaveBrake® Combos	97	86876176629
FG9C7400YEL	Yellow	Dirty Water Bucket for WaveBrake® Combos	97	86876176612
FG9C83010000		SeBreeze® Odor-absorbing Gel — Fresh Apple	263	86876177138
FG9C84010000		SeBreeze® Odor-absorbing Gel — Citrus Breeze	263	86876177022
FG9C85010000		SeBreeze® Odor-absorbing Gel — Ocean Breeze	263	86876177039
FG9F1200CGRAY	Cool Gray	ProServe® Insulated End-Load, Full-Pan Carrier, Small	238	86876166750
FG9F1300CGRAY	Cool Gray	ProServe® Insulated End-Load, Full-Pan Carrier, Medium	238	86876166767
FG9F1400CGRAY	Cool Gray	ProServe® Insulated End-Load, Full-Pan Carrier, Large	238	86876166774
FG9F1500CGRAY	Cool Gray	ProServe® Insulated Top-Load, Half-Pan Carrier	238	86876166781
FG9F1600CGRAY	Cool Gray	ProServe® Insulated Top-Load, Full-Pan Carrier	238	86876166798
FG9F1900BLA	Black	ProServe® Insulated Carrier Dolly with Retention Strap	238	86876166828
FG9F3500RED	Red	ProServe® Pizza Delivery Bag, Small	239	86876172577
FG9F3600RED	Red	ProServe® Pizza Delivery Bag, Medium	239	86876172584
FG9F3700RED	Red	ProServe® Pizza Delivery Bag, Large	239	86876172591
FG9F3800RED	Red	ProServe® Pizza/Catering/Sandwich Delivery Bag, Medium	239	86876172607
FG9F3900RED	Red	ProServe® Pizza/Catering/Sandwich Delivery Bag, Large	239	86876172614
FG9F4000RED	Red	ProServe® Sandwich Delivery Bag	239	86876172621
FG9F43000000		Scoop Holder	237	86876200362
FG9F5000BLUE	Blue	74-oz Scoop with Hand Guard	237	86876200348
FG9F5100BLUE	Blue	74-oz Scoop with Hand Guard and Holder	237	86876200355
FG9F5300BLUE	Blue	Ice Tote	237	86876200386
FG9F5400BLUE	Blue	Ice Tote with Bin Hook Adapter	237	86876200393
FG9F5500BLA	Black	Ice Cart	237	86876202427
FG9F5600		Ice Bin Hook Adapter	237	
FG9F7300BLA	Black	Ice Tote Lid	237	86876201772
FG9F7500CLR	Clear	Bouncer® Contour Scoop for FG360088, FG360288, FG360388 Ingredient Bins (32-oz scoop)	233	86876176773

PART NO.	Color	DESCRIPTION	PAGE	UPC
FG9F7600CLR	Clear	Bouncer® Contour Scoop for FG360088, FG360288, FG360388 Ingredient Bins and FG9G7800	223	86876176780
FG9F7600CLR	Clear	Bouncer® Contour Scoop for FG360088, FG360288, FG360388 Ingredient Bins (64-oz scoop)	233	86876176780
FG9F7700CLR	Clear	Sliding Lid with 32-oz (0.9-L) Scoop for FG360088 Ingredient Bin	222	86876176797
FG9F7800CLR	Clear	Sliding Lid with 32-oz (0.9-L) Scoop for FG360288 Ingredient Bin	222	86876176803
FG9F7900CLR	Clear	Sliding Lid with 32-oz (0.9-L) Scoop for FG360388 Ingredient Bin	222	86876176810
FG9F8600WHT	White	"ICE ONLY" Container	81	86876173086
FG9F8600WHT	White	"ICE ONLY" Container	237	86876173086
FG9F9000CLR	Clear	Vinyl Rack Cover for FG9F9700, FG332000 Racks	239	86876169508
FG9F9700BLA	Black	ProServe® Standard Base Sheet Pan Rack	239	86876166507
FG9G5100CLR	Clear	Bouncer® Portioning Scoop for FG9G5700, FG9G5800 Shelf Ingredient Bins and FG9G7600, FG9G7300	223	86876183610
FG9G5100CLR	Clear	Bouncer® Portioning Scoop — 2 Cup	233	86876183610
FG9G5200CLR	Clear	Bouncer® Portioning Scoop for FG9G7700, FG9G7400 Sliding Lid	223	86876183627
FG9G5200CLR	Clear	Bouncer® Portioning Scoop — 3 Cup	233	86876183627
FG9G5300CLR	Clear	Bouncer® Portioning Scoop for FG9G7800, FG9G7500 Sliding Lid	223	86876183634
FG9G5300CLR	Clear	Bouncer® Portioning Scoop — 4 Cup	233	86876183634
FG9G5400CLR	Clear	Bouncer® Portioning Scoop — 8 Cup	233	86876183641
FG9G5700WHT	White	100-Cup Shelf Ingredient Bin with 2-Cup Scoop	222	86876189957
FG9G5800WHT	White	200-Cup Shelf Ingredient Bin with 2-Cup Scoop	222	86876189964
FG9G5900CHRM	Chrome	Cart for Shelf Ingredient Bins	223	86876189971
FG9G6000WHT	White	40-Cup Shelf Ingredient Bin with 1/2-Cup Scoop	222	86876203578
FG9G7300WHT	White	Sliding Lid w/ 2-Cup Scoop and FG261000 BRUTE® Container COMBO	80	86876203745
FG9G7300WHT	White	Sliding Lid w/ 2-Cup Scoop and FG261088 BRUTE® Container COMBO	224	86876203745
FG9G7400WHT	White	Sliding Lid w/ 3-Cup Scoop and FG262000 BRUTE® Container COMBO	80	86876203752
FG9G7400WHT	White	Sliding Lid w/ 3-Cup Scoop and FG262088 BRUTE® Container COMBO	224	86876203752
FG9G7500WHT	White	Sliding Lid w/ 4-Cup Scoop and FG263200 BRUTE® Container COMBO	80	86876203769
FG9G7500WHT	White	Sliding Lid w/ 4-Cup Scoop and FG263288 BRUTE® Container COMBO	224	86876203769
FG9G7600WHT	White	Sliding Lid with 2-Cup Scoop (fits FG261000 BRUTE® Container)	80	86876203585
FG9G7600WHT	White	Sliding Lid with 2-Cup Scoop (fits FG261088 BRUTE® Container)	224	86876203585
FG9G7700WHT	White	Sliding Lid with 3-Cup Scoop (fits FG262000 BRUTE® Container)	80	86876203592

PART NO.	Color	DESCRIPTION	PAGE	UPC
FG9G7700WHT	White	Sliding Lid with 3-Cup Scoop (fits FG262088 BRUTE® Container)	224	86876203592
FG9G7800WHT	White	Sliding Lid with 4-Cup Scoop (fits FG263200 BRUTE® Container)	80	86876203608
FG9G7800WHT	White	Sliding Lid with 4-Cup Scoop (fits FG263288 BRUTE® Container)	224	86876203608
FG9G7900CHRM	Chrome	Mobile Rack for Shelf Ingredient Bins, 38" wide	223	86876203776
FG9G8000CHRM	Chrome	Mobile Rack for Shelf Ingredient Bins, 50" wide	223	86876203783
FG9G8200WHT	White	½-Cup Measuring Scoop for FG9G6000 Shelf Ingredient Bin	223	86876203868
FG9G8200WHT	White	Measuring Scoop	232	86876203868
FG9M0100BLA	Black	Lobby Pro® Wet/Dry Cleaning Wand	134	86876164596
FG9P9000BEIG	Beige	Plaza® Jr. Container	63	86876167030
FG9P9000BLA	Black	Plaza® Jr. Container	63	86876167047
FG9P9000DGRN	Dark Green	Plaza® Jr. Container	63	86876167023
FG9P9100BLA	Black	Plaza® Jr. Container with Ash Tray Top	63	86876167078
FG9S0000YEL	Yellow	Pop-Up Safety Cone, 20" (50.8 cm) with Multilingual "Caution" Imprint and Wet Floor Symbol	156	86876165951
FG9S0100YEL	Yellow	Pop-Up Safety Cone, 30" (76.2 cm) with Multilingual "Caution" Imprint and Wet Floor Symbol	156	86876165968
FG9S0700YEL	Yellow	Folding Safety Cone with "Caution" Imprint, English, Spanish, French	156	86876173345
FG9S0725YEL	Yellow	Folding Safety Cone with International Wet Floor Symbol	156	86876173352
FG9S0925YEL	Yellow	Stable Safety Sign with International Wet Floor Symbol	154	86876173321
FG9S09DPYEL	Yellow	Stable Safety Sign with "Caution" Imprint, English, Spanish, French	154	86876204643
FG9S1100YEL	Yellow	Mobile Barrier	157	86876166729
FG9S1500YEL	Yellow	Site Safety Hanging Sign with "Closed for Cleaning" Imprint – English Only	155	86876166590
FG9S1600YEL	Yellow	Site Safety Hanging Sign with Multilingual "Closed for Cleaning" Imprint	155	86876166606
FG9S3000GRAY	Gray	BRUTE® Tote with Lid	187	86876166156
FG9S3000WHT	White	BRUTE® Tote with Lid	187	86876166163
FG9S3100GRAY	Gray	BRUTE® Tote with Lid	187	86876166187
FG9S3100WHT	White	BRUTE® Tote with Lid	187	86876166194
FG9T0000BLA	Black	Executive Protective Security Hood for Traditional Housekeeping Carts	144	86876192490
FG9T0000PLAT	Platinum	Executive Protective Security Hood for Traditional Housekeeping Carts	144	86876164763
FG9T1300BLA	Black	Structural Foam Tilt Truck, Utility-Duty	164	86876184167
FG9T1400BLA	Black	Structural Foam Tilt Truck, Standard-Duty	164	86876184174
FG9T1500BLA	Black	Structural Foam Tilt Truck, Standard-Duty	164	86876184204
FG9T1600BLA	Black	Structural Foam Tilt Truck, Heavy-Duty	164	86876184211
FG9T1700BLA	Black	Tilt Truck (RM)	165	86876165593
FG9T1800BLA	Black	Tilt Truck	165	86876165609
FG9T1900BLA	Black	Executive Full-Size Housekeeping Cart with Doors and Hood - Traditional	140	86876192445
FG9T2200BLA	Black	Lid for 1/2-Cubic-Yard Tilt Trucks	165	86876184228
FG9T2300BLA	Black	Lid for 1-Cubic-Yard Tilt Trucks	164	86876184242

PART NO.	Color	DESCRIPTION	PAGE	UPC
FG9T4500	Black	StockMate® ES Restocking Truck with Hinged Deck	220	
FG9T4800	Black	StockMate® Restocking Truck, Standard Deck	220	
FG9T5000	Black	StockMate® Restocking Truck, Standard Deck with Cardboard Management System, Polyurethane Wheels and Casters	220	
FG9T5200	Black	StockMate® Restocking Truck, Utility Deck, Olefin Wheels and Casters	220	
FG9T6571BEIG	Beige	Utility Cart with 3" dia (7.6 cm) Swivel Casters	177	
FG9T6600BLA	Black	Flat Handle Utility Cart (Small) with 5" Casters	173	
FG9T6700BLA	Black	Flat Handle Utility Cart (Med) with 5" Casters	173	
FG9T6800BLA	Black	Executive Service Cart	176	86876200447
FG9T6800BLA	Black	Executive Service Cart	313	86876200447
FG9T7200BLA	Black	Janitorial Cleaning Cart – High-Capacity	139	86876180572
FG9T7300BLA	Black	Janitorial Cleaning Cart w/Bins – High-Capacity	182	86876180589
FG9T73010000		Lock 'N Go Accessory	182	
FG9T73010000		Lock 'N Go Accessory	138	86876188363
FG9T73010000		Lock 'N Go Accessory	139	86876188363
FG9T7400BLA	Black	Janitorial Cleaning Cart Full Swivel w/Bins – High-Capacity	138	
FG9T7500BLA	Black	Janitorial Cleaning Cart – High-Security	138	86876180602
FG9T7800BLA	Black	Executive Housekeeping Compact Cart – High-Security	142	86876180633
FG9T8200BLA	Black	Executive 10-Quart Heavy-Duty Caddy	140	86876180671
FG9T8200YEL	Yellow	10-Quart Heavy-Duty Caddy	140	
FG9T8400YEL	Yellow	30-Quart Organizing Bins – Yellow	140	86876180695
FG9T8600BLA	Black	Executive Preassembled Locking Security Hood	140	86876180718
FG9T89010000		Executive Triple Waste Wire Bag Divider	140	86876186321
FG9T9000BLA	Black	Executive 9-Pocket Fabric Hanging Organizer Cart Caddy	144	86876182101
FG9T9200BLA	Black	Janitorial Cleaning and Recycling Triple Capacity Cart – High-Capacity	184	86876187946
FG9W0000BLA	Black	Landmark Series® Standard Funnel Top	61	86876166880
FG9W0100BLA	Black	Landmark Series® Standard Dome Top	61	86876166897
FG9W0200BLA	Black	Landmark Series® Funnel Top with Panel Frame and FG9S5800 Rigid Liner	61	86876166903
FG9W0300BLA	Black	Landmark Series® Dome Top with Panel Frame and FG9S5800 Rigid Liner	61	86876166910
FG9W0400BLA	Black	Window Wash Kit for FG9W0000, FG9W0100, FG9W0200, FG9W0300 Containers	61	86876166927
FG9W1088GRAY	Gray	BRUTE® Confidential Document Rollout Container	19	86876168778
FG9W1188GRAY	Gray	BRUTE® Confidential Document Rollout Container	19	
FG9W1600L	Gray	Slim Jim® Confidential Document Lid	26	
FG9W2100GRAY	Gray	BRUTE® Rollout Container with Lid	17	86876168792
FG9W2173BLUE	Blue	BRUTE® Rollout Container with Lid	17	86876194326
FG9W2200GRAY	Gray	BRUTE® Rollout Container with Lid	17	86876169058
FG9W2273BLUE	Blue	BRUTE® Rollout Container with Lid	17	86876194333



UTILITY AND RECYCLING REFUSE

DECORATIVE REFUSE

CLEANING

MATERIAL HANDLING

WASHROOM

FOODSERVICE

ACCESSORIES & INDEX

PART NO.	Color	DESCRIPTION	PAGE	UPC
FG9W2700BLUE	Blue	BRUTE® Rollout Container with Lid	17	86876176636
FG9W2700GRAY	Gray	BRUTE® Rollout Container with Lid	17	86876175387
FG9W2700YEL	Yellow	BRUTE® Rollout Container with Lid	17	86876176643
FG9W2773BLUE	Blue	BRUTE® Recycling Rollout Container with Lid	19	86876194340
FG9W29000000		Security Kit for GroundsKeeper® Tuscan Receptacle	66	
FG9W3000BLA	Black	GroundsKeeper® Tuscan Receptacle	66	86876173055
FG9W3000SSTON	Sandstone	GroundsKeeper® Tuscan Receptacle	66	86876173048
FG9W3100SSBLA	Stainless Steel/Black Top	Infinity™ Base-Mount Smoking Receptacle	67	86876183450
FG9W3200SSBLA	Stainless Steel/Black Top	Infinity™ Wall-Mount Smoking Receptacle	67	86876183467
FG9W3300AGBRNZ	Aged Bronze	Infinity™ Traditional Smoking Receptacle	67	86876183481
FG9W3300ATPWTR	Antique Pewter	Infinity™ Traditional Smoking Receptacle	67	
FG9W3300BLA	Black	Infinity™ Traditional Smoking Receptacle	67	86876183474
FG9W3400AGBRNZ	Aged Bronze	Infinity™ Ultra-High-Capacity Smoking Receptacle	67	86876183511
FG9W3400ATPWTR	Antique Pewter	Infinity™ Ultra-High-Capacity Smoking Receptacle	67	86876183528
FG9W3400BLA	Black	Infinity™ Ultra-High-Capacity Smoking Receptacle	67	86876183504
FG9W7300BLA	Black	Executive Mega BRUTE® Mobile Collector – 1-Pack	79	86876182644
FG9W7200BLA	Black	Executive Mega BRUTE® Mobile Collector Lid	79	86876182651
FG9W8700YEL	Yellow	BRUTE® Rim Caddy for 44-Gallon Containers	15	86876172539
FGA11106BL00	Blue	Web Foot® Wet Mop	104	86876090185
FGA11106WH00	White	Web Foot® Wet Mop	104	86876090161
FGA11206BL00	Blue	Web Foot® Wet Mop	104	86876090451
FGA11206GR00	Green	Web Foot® Wet Mop	104	86876090444
FGA11206OR00	Orange	Web Foot® Wet Mop	104	86876090468
FGA11206WH00	White	Web Foot® Wet Mop	104	86876090437
FGA11306BL00	Blue	Web Foot® Wet Mop	104	86876090710
FGA11306GR00	Green	Web Foot® Wet Mop	104	86876090703
FGA11306OR00	Orange	Web Foot® Wet Mop	104	86876090727
FGA11306WH00	White	Web Foot® Wet Mop	104	86876090697
FGA15106BL00	Blue	Web Foot® Wet Mop	104	86876091274
FGA15106GR00	Green	Web Foot® Wet Mop	104	86876091267
FGA15106WH00	White	Web Foot® Wet Mop	104	86876091250
FGA15206BL00	Blue	Web Foot® Wet Mop	104	86876091557
FGA15206GR00	Green	Web Foot® Wet Mop	104	86876091540
FGA15206OR00	Orange	Web Foot® Wet Mop	104	86876091564
FGA15206WH00	White	Web Foot® Wet Mop	104	86876091533
FGA15306BL00	Blue	Web Foot® Wet Mop	104	86876091830
FGA15306GR00	Green	Web Foot® Wet Mop	104	86876145168
FGA15306OR00	Orange	Web Foot® Wet Mop	104	86876091847
FGA15306WH00	White	Web Foot® Wet Mop	104	86876091816
FGA21106BL00	Blue	Web Foot® Shrinkless® Wet Mop	104	86876092356
FGA21106GR00	Green	Web Foot® Shrinkless® Wet Mop	104	86876092349
FGA21106WH00	White	Web Foot® Shrinkless® Wet Mop	104	86876055238
FGA21206BL00	Blue	Web Foot® Shrinkless® Wet Mop	104	86876092516
FGA21206GR00	Green	Web Foot® Shrinkless® Wet Mop	104	86876055429
FGA21206WH00	White	Web Foot® Shrinkless® Wet Mop	104	86876055252

PART NO.	Color	DESCRIPTION	PAGE	UPC
FGA21306BL00	Blue	Web Foot® Shrinkless® Wet Mop	104	86876092660
FGA21306GR00	Green	Web Foot® Shrinkless® Wet Mop	104	86876145175
FGA21306WH00	White	Web Foot® Shrinkless® Wet Mop	104	86876055276
FGA25106BL00	Blue	Web Foot® Shrinkless® Wet Mop	104	86876092998
FGA25106GR00	Green	Web Foot® Shrinkless® Wet Mop	104	86876092981
FGA25106OR00	Orange	Web Foot® Shrinkless® Wet Mop	104	86876145182
FGA25106WH00	White	Web Foot® Shrinkless® Wet Mop	104	86876092974
FGA25206BL00	Blue	Web Foot® Shrinkless® Wet Mop	104	86876093148
FGA25206GR00	Green	Web Foot® Shrinkless® Wet Mop	104	86876093131
FGA25206OR00	Orange	Web Foot® Shrinkless® Wet Mop	104	86876093155
FGA25206WH00	White	Web Foot® Shrinkless® Wet Mop	104	86876093124
FGA25306BL00	Blue	Web Foot® Shrinkless® Wet Mop	104	86876093254
FGA25306GR00	Green	Web Foot® Shrinkless® Wet Mop	104	86876093247
FGA25306OR00	Orange	Web Foot® Shrinkless® Wet Mop	104	86876145199
FGA25306WH00	White	Web Foot® Shrinkless® Wet Mop	104	86876055344
FGA41206WH00	White	Web Foot® Finish Mop	105	86876093490
FGA41306WH00	White	Web Foot® Finish Mop	105	86876093506
FGAB1		Anchoring Bolt	70	
FGAOT15BKPL	Black Gloss	Open Top 56L/15G	53	97591018736
FGAOT15SAPL	Satin Aluminum	Open Top 56L/15G	53	97591018934
FGAOT30BKPL	Textured Black	Open Top 113L/30G	53	97591043950
FGAOT35SA	Satin Aluminum	Open Top 132L/35G	55	97591002124
FGAOT35SAGL	Satin Aluminum	Open Top 79L/21G	55	97591041758
FGAOT35SAPL	Satin Aluminum	Open Top 79L/21G	55	97591041802
FGAOT62SA	Satin Aluminum	Open Top 234L/62G	55	97591018002
FGAOT62SAPL	Satin Aluminum	Open Top 208L/55G	55	97591041970
FGA81206	Green	Web Foot® Microfiber String Mop	103	
FGA85206	Green	Web Foot® Microfiber String Mop	103	
FGA85306	Green	Web Foot® Microfiber String Mop	103	
FGA81306	Green	Web Foot® Microfiber String Mop	103	
FGB25		Black Sand, Five 5-Lb Bags	70	
FGBBT1529BK	Black	Fits FGWB44, FGWB2029	42	97591030301
FGBBT1529GR	Green	Fits FGWB44, FGWB2031	42	97591029800
FGBP1		Label "Biohazard"	56	
FGC11106WH00	White	Swinger Loop® Wet Mop	105	86876057676
FGC11206BL00	Blue	Swinger Loop® Wet Mop	105	86876057935
FGC11206GR00	Green	Swinger Loop® Wet Mop	105	86876057928
FGC11206WH00	White	Swinger Loop® Wet Mop	105	86876057911
FGC11306BL00	Blue	Swinger Loop® Wet Mop	105	86876058178
FGC11306GR00	Green	Swinger Loop® Wet Mop	105	86876058161
FGC11306WH00	White	Swinger Loop® Wet Mop	105	86876058154
FGC11406WH00	White	Swinger Loop® Wet Mop	105	86876058390
FGC15106BL00	Blue	Swinger Loop® Wet Mop	105	86876058659
FGC15106GR00	Green	Swinger Loop® Wet Mop	105	86876058642
FGC15206BL00	Blue	Swinger Loop® Wet Mop	105	86876058895
FGC15206GR00	Green	Swinger Loop® Wet Mop	105	86876058888
FGC15206WH00	White	Swinger Loop® Wet Mop	105	86876145212

PART NO.	Color	DESCRIPTION	PAGE	UPC
FGC15306BL00	Blue	Swinger Loop® Wet Mop	105	86876059137
FGC15306GR00	Green	Swinger Loop® Wet Mop	105	86876059120
FGC15306WH00	White	Swinger Loop® Wet Mop	105	86876059113
FGC15406BL00	Blue	Swinger Loop® Wet Mop	105	86876059373
FGC15406WH00	White	Swinger Loop® Wet Mop	105	86876059359
FGC21206BL00	Blue	Swinger Loop® Shrinkless® Wet Mop	105	86876059854
FGC21206GR00	Green	Swinger Loop® Shrinkless® Wet Mop	105	86876059847
FGC21306BL00	Blue	Swinger Loop® Shrinkless® Wet Mop	105	86876060096
FGC21306GR00	Green	Swinger Loop® Shrinkless® Wet Mop	105	86876060089
FGC21306WH00	White	Swinger Loop® Shrinkless® Wet Mop	105	86876060072
FGC25206BL00	Blue	Swinger Loop® Shrinkless® Wet Mop	105	86876060812
FGC25206GR00	Green	Swinger Loop® Shrinkless® Wet Mop	105	86876060805
FGC25206WH00	White	Swinger Loop® Shrinkless® Wet Mop	105	86876060799
FGC25306BL00	Blue	Swinger Loop® Shrinkless® Wet Mop	105	86876061055
FGC25306GR00	Green	Swinger Loop® Shrinkless® Wet Mop	105	86876061048
FGC25306OR00	Orange	Swinger Loop® Shrinkless® Wet Mop	105	86876171518
FGC25306WH00	White	Swinger Loop® Shrinkless® Wet Mop	105	86876061031
FGC25406WH00	White	Swinger Loop® Shrinkless® Wet Mop	105	86876061277
FGC41206WH00	White	Swinger Loop® Finish Mop	107	86876061529
FGC41306WH00	White	Swinger Loop® Finish Mop	107	86876145250
FGCC16SSSGL	Stainless Steel	Open Top 56L/15G	54	97591010570
FGCL1		English/Spanish Label "Biohazard"	52	
FGCL2		English/Spanish Label "Soiled Linen"	52	
FGCL3		English/Spanish Label "Trash Only"	52	
FGCL4		English/Spanish Label "Infectious Waste"	52	
FGD11306WH00	White	Super Stitch® Cotton Looped-End Wet Mop	108	86876064094
FGD21106BL00	Blue	Super Stitch® Blend Mop	109	86876064391
FGD21106WH00	White	Super Stitch® Blend Mop	109	86876064377
FGD21206BL00	Blue	Super Stitch® Blend Mop	109	86876064599
FGD21206GR00	Green	Super Stitch® Blend Mop	109	86876064582
FGD21206RD00	Red	Super Stitch® Blend Mop	109	86876155013
FGD21206WH00	White	Super Stitch® Blend Mop	109	86876064575
FGD21306BL00	Blue	Super Stitch® Blend Mop	109	86876064797
FGD21306GR00	Green	Super Stitch® Blend Mop	109	86876064780
FGD21306RD00	Red	Super Stitch® Blend Mop	109	86876155020
FGD21306WH00	White	Super Stitch® Blend Mop	109	86876064773
FGD21406WH00	White	Super Stitch® Blend Mop	109	86876171532
FGD25106BL00	Blue	Super Stitch® Blend Mop	109	86876065190
FGD25106WH00	White	Super Stitch® Blend Mop	109	86876065176
FGD25206BL00	Blue	Super Stitch® Blend Mop	109	86876065398
FGD25206GR00	Green	Super Stitch® Blend Mop	109	86876065381
FGD25206RD00	Red	Super Stitch® Blend Mop	109	86876155037
FGD25206WH00	White	Super Stitch® Blend Mop	109	86876065374
FGD25306BL00	Blue	Super Stitch® Blend Mop	109	86876065596
FGD25306GR00	Green	Super Stitch® Blend Mop	109	86876065589
FGD25306RD00	Red	Super Stitch® Blend Mop	109	86876155044
FGD25306WH00	White	Super Stitch® Blend Mop	109	86876065572
FGD25406WH00	White	Super Stitch® Blend Mop	109	86876171549
FGD41206WH00	White	Super Stitch® Rayon Mop	107	86876065978
FGD41306WH00	White	Super Stitch® Rayon Mop	107	86876066012
FGD45306WH00	White	Super Stitch® Rayon Mop	107	86876167283
FGD51206WH00	White	Super Stitch® Finish Mop	107	86876154825
FGD51306WH00	White	Super Stitch® Finish Mop	107	86876154832

PART NO.	Color	DESCRIPTION	PAGE	UPC
FGD55206WH00	White	Super Stitch® Finish Mop	107	86876154931
FGD55306WH00	White	Super Stitch® Finish Mop	107	86876154948
FGDCR24CSM	Stardust Silver Metallic	Square Recycle with Bottle/Cans Lid/Label 109L/29G	14	97591128657
FGDCR24TSM	Stardust Silver Metallic	Square Recycle with Trash Lid/Label 109L/29G	14	97591128671
FGE05200WH00	White	Finish Mop, Looped Fringe	90	86876118339
FGE13600WH00	White	Universal Headband Cotton Mop	110	86876050103
FGE13800WH00	White	Universal Headband Cotton Mop	110	86876047813
FGE13900WH00	White	Universal Headband Cotton Mop	110	86876047790
FGE23600BL00	Blue	Universal Headband Blue Blend Mop	109	86876050141
FGE23800BL00	Blue	Universal Headband Blue Blend Mop	109	86876050165
FGE23900BL00	Blue	Universal Headband Blue Blend Mop	109	86876050172
FGE43600WH00	White	Universal Headband Rayon Mop	109	86876050196
FGE43800WH00	White	Universal Headband Rayon Mop	109	86876050219
FGF11600WH00	White	Premium Cut-End Cotton Mop	111	86876050240
FGF11700WH00	White	Premium Cut-End Cotton Mop	111	86876045925
FGF11800WH00	White	Premium Cut-End Cotton Mop	111	86876044713
FGF11900WH00	White	Premium Cut-End Cotton Mop	111	86876046038
FGF13100BL00	Blue	Synthetic Blend Mop	113	86876116304
FGF13100GR00	Green	Synthetic Blend Mop	113	86876116311
FGF13100PINK	Pink	Synthetic Blend Mop	113	86876116328
FGF13200BL00	Blue	Synthetic Blend Mop	113	86876116342
FGF13200GR00	Green	Synthetic Blend Mop	113	86876116359
FGF13600BL00	Blue	Synthetic Blend Mop	113	86876116427
FGF13600GR00	Green	Synthetic Blend Mop	113	86876116434
FGF13700BL00	Blue	Synthetic Blend Mop	113	86876116465
FGF13700GR00	Green	Synthetic Blend Mop	113	86876116472
FGF13700PINK	Pink	Synthetic Blend Mop	113	86876116489
FGF15600WH00	White	Premium Cut-End Cotton Mop	111	86876050264
FGF15700WH00	White	Premium Cut-End Cotton Mop	111	86876050271
FGF15800WH00	White	Premium Cut-End Cotton Mop	111	86876046045
FGF15900WH00	White	Premium Cut-End Cotton Mop	111	86876067385
FGF21600WH00	White	Premium Cut-End Cotton Mop	111	
FGF16600WH00	White	Premium Bolt-On Cut-End Cotton Mop	113	86876046052
FGF16700WH00	White	Premium Bolt-On Cut-End Cotton Mop	113	86876067477
FGF16800WH00	White	Premium Bolt-On Cut-End Cotton Mop	113	86876046069
FGF21700WH00	White	Premium 8-Ply Cut-End Cotton Mop	113	86876067927
FGF21800WH00	White	Premium 8-Ply Cut-End Cotton Mop	113	86876067958
FGF21900WH00	White	Premium 8-Ply Cut-End Cotton Mop	113	86876067989
FGF41600WH00	White	Premium Cut-End Rayon Mop	110	86876068948
FGF41700WH00	White	Premium Cut-End Rayon Mop	110	86876045949
FGF41800WH00	White	Premium Cut-End Rayon Mop	110	86876044720
FGF46700WH00	White	Premium Bolt-On Cut-End Rayon Mop	112	86876069273
FGF46800WH00	White	Premium Bolt-On Cut-End Rayon Mop	112	86876069303
FGF51600BL00	Blue	Premium Cut-End Blend Mop	110	86876049145
FGF51700BL00	Blue	Premium Cut-End Blend Mop	110	86876049152
FGF51700WH00	White	Premium Cut-End Blend Mop	110	86876045932
FGF51800BL00	Blue	Premium Cut-End Blend Mop	110	86876049169
FGF51800WH00	White	Premium Cut-End Blend Mop	110	86876045857
FGF51900BL00	Blue	Premium Cut-End Blend Mop	110	86876049121
FGF55600BL00	Blue	Premium Cut-End Blend Mop	110	86876070408
FGF55700BL00	Blue	Premium Cut-End Blend Mop	110	86876070521
FGF55800BL00	Blue	Premium Cut-End Blend Mop	110	86876070644
FGF56600BL00	Blue	Premium Bolt-On Cut-End Blend Mop	112	86876071009

UTILITY AND RECYCLING REFUSE

DECORATIVE REFUSE

CLEANING

MATERIAL HANDLING

WASHROOM

FOODSERVICE

ACCESSORIES & INDEX



PART NO.	Color	DESCRIPTION	PAGE	UPC
FGF56700BL00	Blue	Premium Bolt-On Cut-End Blend Mop	112	86876064537
FGF56800BL00	Blue	Premium Bolt-On Cut-End Blend Mop	112	86876066043
FGF55900	Blue	Premium Cut-End Blend Mop	110	
FGG78004		PVA Sponge Mop	117	41301112146
FGG78112		PVA Sponge Mop Refill	117	41301112153
FGGO4300WH00	White	Replacement Mop Head for FGGO4204	117	
FGH115000000		Invader® Side-Gate Wet Mop Handle, Large Yellow Plastic Head, Hardwood Handle	115	86876045444
FGH116000000		Invader® Side-Gate Wet Mop Handle, Large Yellow Plastic Head, Hardwood Handle	115	86876045956
FGH124000000		User-Friendly Mop Handle with Side-Gate Head	116	86876159417
FGH125000000		Invader® Side-Gate Wet Mop Handle, Large Yellow Plastic Head, Gray Aluminum Handle	115	86876050394
FGH126000000		Invader® Side-Gate Wet Mop Handle, Large Yellow Plastic Head, Gray Aluminum Handle	115	86876050400
FGH12IGC	Cedar	In-Ground Post w/ Lumber-Finished Slats 128L/34G	59	97591049488
FGH12SMC	Cedar	Surface Post w/ Lumber-Finished Slats 128L/34G	59	97591042885
FGH135000000		Invader® Side-Gate Wet Mop Handle, Large Yellow Plastic Head, Vinyl-Covered Aluminum Handle	115	86876047912
FGH136000000		Invader® Side-Gate Wet Mop Handle, Large Yellow Plastic Head, Vinyl-Covered Aluminum Handle	115	86876046168
FGH145000000		Invader® Side-Gate Wet Mop Handle, Large Yellow Plastic Head, Fiberglass Handle	115	86876052459
FGH14600BL00	Blue	Invader® Side-Gate Wet Mop Handle, Large Yellow Plastic Head, Fiberglass Handle	115	86876146899
FGH14600GR00	Green	Invader® Side-Gate Wet Mop Handle, Large Yellow Plastic Head, Fiberglass Handle	115	86876146875
FGH14600GY00	Gray	Invader® Side-Gate Wet Mop Handle, Large Yellow Plastic Head, Fiberglass Handle	115	86876147353
FGH14600RD00	Red	Invader® Side-Gate Wet Mop Handle, Large Yellow Plastic Head, Fiberglass Handle	115	86876146882
FGH215000000		Gripper® Clamp-Style Wet Mop Handle, Plastic Yellow Head, Hardwood Handle	115	86876045451
FGH216000000		Gripper® Clamp-Style Wet Mop Handle, Plastic Yellow Head, Hardwood Handle	115	86876046137
FGH225000000		Gripper® Clamp-Style Wet Mop Handle, Plastic Yellow Head, Gray Aluminum Handle	115	86876050448
FGH226000000		Gripper® Clamp-Style Wet Mop Handle, Plastic Yellow Head, Gray Aluminum Handle	115	86876046120
FGH236000000		Gripper® Clamp-Style Wet Mop Handle, Plastic Yellow Head, Vinyl-Coated Aluminum Handle	115	86876050462
FGH245000000		Gripper® Clamp-Style Wet Mop Handle, Plastic Yellow Head, Fiberglass Handle	115	86876052473
FGH24600BL00	Blue	Gripper® Clamp-Style Wet Mop Handle, Plastic Yellow Head, Fiberglass Handle	115	86876146929
FGH24600GR00	Green	Gripper® Clamp-Style Wet Mop Handle, Plastic Yellow Head, Fiberglass Handle	115	86876146905

PART NO.	Color	DESCRIPTION	PAGE	UPC
FGH24600GY00	Gray	Gripper® Clamp-Style Wet Mop Handle, Plastic Yellow Head, Fiberglass Handle	115	86876147360
FGH24600RD00	Red	Gripper® Clamp-Style Wet Mop Handle, Plastic Yellow Head, Fiberglass Handle	115	86876146912
FGH516000000		Easy-Change Wet Mop Handle, Large Steel Head, Wood Handle	115	86876053647
FGJ15100YL00	Yellow	Trapper® Dust Mop	121	86876093698
FGJ15200YL00	Yellow	Trapper® Dust Mop	121	86876093810
FGJ15300YL00	Yellow	Trapper® Dust Mop	121	86876093933
FGJ15500YL00	Yellow	Trapper® Dust Mop	121	86876094176
FGJ15700YL00	Yellow	Trapper® Dust Mop	121	86876094411
FGJ15800YL00	Yellow	Trapper® Dust Mop	121	86876171587
FGJ25200BL00	Blue	Twisted-Loop Blend Dust Mop	120	86876182170
FGJ25300BL00	Blue	Twisted-Loop Blend Dust Mop	120	86876182194
FGJ25500BL00	Blue	Twisted-Loop Blend Dust Mop	120	86876182217
FGJ25700BL00	Blue	Twisted-Loop Blend Dust Mop	120	86876182231
FGJ35200BL00	Blue	Twisted-Loop Synthetic Dust Mop	120	86876182323
FGJ35300BL00	Blue	Twisted-Loop Synthetic Dust Mop	120	86876182330
FGJ35500BL00	Blue	Twisted-Loop Synthetic Dust Mop	120	86876182347
FGJ35700BL00	Blue	Twisted-Loop Synthetic Dust Mop	120	86876182354
FGJ35800BL00	Blue	Twisted-Loop Synthetic Dust Mop	120	86876182361
FGJ55300GR00	Green	Twisted-Loop Blend Antimicrobial Dust Mop	120	86876182286
FGJ55500GR00	Green	Twisted-Loop Blend Antimicrobial Dust Mop	120	86876182293
FGJ55700GR00	Green	Twisted-Loop Blend Antimicrobial Dust Mop	120	86876182309
FGJ85200GR00	Green	Microfiber Loop Dust Mop 18"	119	86876194579
FGJ85300GR00	Green	Microfiber Loop Dust Mop 24"	119	86876194586
FGJ85500GR00	Green	Microfiber Loop Dust Mop 36"	119	86876194593
FGJ85700GR00	Green	Microfiber Loop Dust Mop 48"	119	86876194609
FGJ85800GR00	Green	Microfiber Loop Dust Mop 60"	119	86876204063
FGJ85900GR00	Green	Microfiber Loop Dust Mop 72"	119	86876204070
FGK15200BL00	Blue	Kut-A-Way® Dust Mop	121	86876081336
FGK15200WH00	White	Kut-A-Way® Dust Mop	121	86876049176
FGK15300BL00	Blue	Kut-A-Way® Dust Mop	121	86876081855
FGK15300WH00	White	Kut-A-Way® Dust Mop	121	86876045499
FGK15500BL00	Blue	Kut-A-Way® Dust Mop	121	86876082913
FGK15500WH00	White	Kut-A-Way® Dust Mop	121	86876050677
FGK15700BL00	Blue	Kut-A-Way® Dust Mop	121	86876083958
FGK15700WH00	White	Kut-A-Way® Dust Mop	121	86876050691
FGK15800WH00	White	Kut-A-Way® Dust Mop	121	86876050707
FGK15900WH00	White	Kut-A-Way® Dust Mop	121	86876050714
FGK165S		Compact Portion Control Scale	235	77177025013
FGK32		Oven-Run Scale with 1 pt Measuring Cup	235	77177125034
FGK75300WH00	White	Twisted-Loop Cotton Dust Mop	120	86876182132
FGK75500WH00	White	Twisted-Loop Cotton Dust Mop	120	86876182149
FGKF16SS		Compact Portion Control Scale with Contoured Platform	235	77177125027
FGKR12		Anchoring Kit	70	
FGKR52C		Anchoring Kit (concrete)	70	
FGL15300GR00	Green	Blended Cut-End Disposable Dust Mop	121	86876087369
FGL15300WH00	White	Blended Cut-End Disposable Dust Mop	121	86876045505
FGL15500WH00	White	Blended Cut-End Disposable Dust Mop	121	86876087598
FGL15700GR00	Green	Blended Cut-End Disposable Dust Mop	121	86876087840
FGL15700WH00	White	Blended Cut-End Disposable Dust Mop	121	86876087833
FGL15800WH00	White	Blended Cut-End Disposable Dust Mop	121	86876087956

PART NO.	Color	DESCRIPTION	PAGE	UPC
FGL15900WH00	White	Blended Cut-End Disposable Dust Mop	121	86876088076
FGL25300WH00	White	Cut-End Disposable Cotton Dust Mop	122	86876051841
FGL25500WH00	White	Cut-End Disposable Cotton Dust Mop	122	86876051865
FGL25700WH00	White	Cut-End Disposable Cotton Dust Mop	122	86876051889
FGM116000000		Snap-On Dust Mop Handle, Hardwood	122	86876046182
FGM136000000		Snap-On Dust Mop Handle, Vinyl-Covered, Hardwood	122	86876052824
FGM146000000		Snap-On Dust Mop Handle, Fiberglass	122	86876052497
FGM15000WH00	White	Cut-to-Length Dust Mop	123	86876144383
FGM251000000		Snap-On Wire Dust Mop Frame	122	86876089394
FGM252000000		Snap-On Wire Dust Mop Frame	122	86876089417
FGM253000000		Snap-On Wire Dust Mop Frame	122	86876046199
FGM255000000		Snap-On Wire Dust Mop Frame	122	86876089479
FGM257000000		Snap-On Wire Dust Mop Frame	122	86876089516
FGM258000000		Snap-On Wire Dust Mop Frame	122	86876089530
FGM259000000		Snap-On Wire Dust Mop Frame	122	86876089554
FGMT22	Architectural Bronze	Americana Series™ Open Top	59	
FGMT22	Black	Americana Series™ Open Top	59	
FGMT32	Architectural Bronze	Americana Series™ Open Top	59	
FGMT32	Black	Americana Series™ Open Top	59	
FGMT32	Green	Americana Series™ Open Top	59	
FGP100S		Briefcase Receiving Scale	236	86876208009
FGP11700WH00	White	Standard Thickness Bonnet	125	86876089738
FGP11900WH00	White	Standard Thickness Bonnet	125	86876089745
FGP12100WH00	White	Standard Thickness Bonnet	125	86876089752
FGP250S		Briefcase Receiving Scale	236	86876208023
FGP250SS		Briefcase Receiving Scale	236	77177068621
FGP26700WH00	White	Low-Profile with Green Scrub Strips Bonnet	125	86876095418
FGP26900WH00	White	Low-Profile with Green Scrub Strips Bonnet	125	86876095425
FGP27100WH00	White	Low-Profile with Green Scrub Strips Bonnet	125	86876120578
FGHPIG		Towne Series In-Ground Pole with Hardware	38	
FGQ050000000		Microfiber Finish System, Includes Bucket with Lid, Sieve, 8 Pads, 1 Frame	90	86876204865
FGQ11000BK00	Black	11" (27.9 cm) HYGEN™ Hook-and-Loop Replacement Set for FGQ55000	80	86876174885
FGQ18000BK00	Black	17" (43.2 cm) HYGEN™ Hook-and-Loop Replacement Set for FGQ56000	80	86876174892
FGQ24000BK00	Black	24" (61 cm) Hook-and-Loop Replacement Set for FGQ57000	80	86876174908
FGQ25700WH00	White	17" Microfiber Carpet Bonnet	125	86876201062
FGQ25900WH00	White	19" Microfiber Carpet Bonnet	125	86876201079
FGQ36000BK00	Black	35" (88.9 cm) HYGEN™ Hook-and-Loop Replacement Set for FGQ58000	79	86876174915
FGQ40800GR00	Green	18" (45.7 cm) Light Commercial Microfiber Fringed Dust Mop	88	
FGQ40900BL00	Blue	18" (45.7 cm) Light Commercial Microfiber Damp Mop	88	
FGQ41000BL00	Blue	18" (45.7 cm) HYGEN™ Microfiber Super Scrubber Mop	79	86876170016

PART NO.	Color	DESCRIPTION	PAGE	UPC
FGQ41000GR00	Green	18" (45.7 cm) HYGEN™ Microfiber Super Scrubber Mop	79	86876174052
FGQ41000RD00	Red	18" (45.7 cm) HYGEN™ Microfiber Super Scrubber Mop	79	86876174045
FGQ41100BL00	Blue	24" (61 cm) HYGEN™ Microfiber Damp Room Mop	79	86876173734
FGQ41200GR00	Green	18" (45.7 cm) HYGEN™ Microfiber Room Dust Mop	78	86876175448
FGQ41200WH00	White	18" (45.7 cm) HYGEN™ Microfiber Room Dust Mop	78	86876170023
FGQ41500BL00	Blue	18" (45.7 cm) HYGEN™ Microfiber Damp Mop with Scrubber	79	86876174946
FGQ41600BL00	Blue	18" (45.7 cm) HYGEN™ Microfiber High-Absorbency Mop	79	86876174960
FGQ41800GR00	Green	18" (45.7 cm) HYGEN™ Microfiber Fringed Dust Mop	78	86876174939
FGQ42400GR00	Green	24" (61 cm) HYGEN™ Microfiber Hall Dust Mop	78	86876170139
FGQ42500BL00	Blue	24" (61 cm) HYGEN™ Microfiber Damp Mop with Scrubber	79	86876174953
FGQ42600GR00	Green	24" (61 cm) HYGEN™ Microfiber Fringed Dust Mop	78	86876182484
FGQ43600GR00	Green	36" (91.4 cm) HYGEN™ Microfiber Hall Dust Mop	78	86876170047
FGQ43800GR00	Green	36" (91.4 cm) HYGEN™ Microfiber Fringed Dust Mop	78	86876182491
FGQ44800GR00	Green	48" (121.9 cm) HYGEN™ Microfiber Hall Dust Mop	78	86876170146
FGQ44900GR00	Green	48" (121.9 cm) HYGEN™ Microfiber Fringed dust Mop	78	86876182507
FGQ46000GR00	Green	60" (152.4 cm) HYGEN™ Microfiber Fringed Dust Mop	78	86876182514
FGQ48000BK00	Black	47" (119.4 cm) HYGEN™ Hook-and-Loop Replacement Set for FGQ59000	80	86876174922
FGQ55000YL00	Yellow	11" (27.9 cm) HYGEN™ Quick-Connect Wet/Dry Frame	80	86876174823
FGQ55900BK00	Black	18" (45.7 cm) Light and Commercial Quick-Connect Wet/Dry Plastic Frame	85	86876186079
FGQ56000YL00	Yellow	17" (43.2 cm) (45.7 cm) HYGEN™ Quick-Connect Wet/Dry Frame	80	86876174830
FGQ57000YL00	Yellow	24" (61 cm) HYGEN™ Quick-Connect Wet/Dry Frame with Squeegee	80	86876174847
FGQ58000YL00	Yellow	35" (88.9 cm) HYGEN™ Quick-Connect Hall Dusting Frame	80	86876174854
FGQ59000YL00	Yellow	47" (119.4 cm) HYGEN™ Quick-Connect Hall Dusting Frame	80	86876174861
FGQ59500YL00	Yellow	59" (149.9 cm) HYGEN™ Quick-Connect Hall Dusting Frame	80	86876182477
FGQ60000BK00	Black	59" (149.9 cm) HYGEN™ Hook-and-Loop Replacement Set for FGQ59500	80	86876186345
FGQ61000YL00	Yellow	HYGEN™ Microfiber Bathroom Cloth (Yellow)	76	86876170085
FGQ62000BL00	Blue	HYGEN™ Microfiber General-Purpose Cloth (Blue)	76	86876179088
FGQ62000GR00	Green	HYGEN™ Microfiber General-Purpose Cloth (Green)	76	86876170092
FGQ62000RD00	Red	HYGEN™ Microfiber General-Purpose Cloth (Red)	76	86876179101
FGQ62006GR00	Green	HYGEN™ Microfiber General-Purpose Cloth (Green)	76	86876170092
FGQ63000BL00	Blue	HYGEN™ Microfiber Glass/Mirror Cloth (Blue)	76	86876170108
FGQ63006BL00	Blue	HYGEN™ Microfiber Glass/Mirror Cloth (Blue)	76	86876178616

UTILITY AND RECYCLING REFUSE

DECORATIVE REFUSE

CLEANING

MATERIAL HANDLING

WASHROOM

FOODSERVICE

ACCESSORIES & INDEX



PART NO.	Color	DESCRIPTION	PAGE	UPC
FGQ64000GR00	Green	HYGEN™ Microfiber XL General-Purpose Cloth (Green)	76	86876170115
FGQ65000GR00	Green	HYGEN™ Microfiber All-Purpose Mitt with Thumb	86	86876173765
FGQ65100BL00	Blue	HYGEN™ Microfiber Glass/Mirror Mitt with Thumb	86	86876173772
FGQ65200GR00	Green	HYGEN™ Microfiber Dusting Mitt with Thumb	86	86876200966
FGQ70100BK00	Black	ACME to HYGEN™ Quick-Connect Adapter	81	86876201000
FGQ74500YL00	Yellow	20"–40" (50.8 cm–101.6 cm) HYGEN™ Quick-Connect Short Extension Handle	81	86876182453
FGQ74900YL00	Yellow	52" (132 cm) Light Commercial Quick-Connect Steel Handle	88	86876186086
FGQ75000YL00	Yellow	58" (147.3 cm) HYGEN™ Quick-Connect Handle	81	86876174809
FGQ75500YL00	Yellow	48"–72" (121.9 cm–182.9 cm) HYGEN™ Quick-Connect Ergo Adjustable Handle	81	86876182460
FGQ760000000		48"–72" (121.9–182.9 cm) HYGEN™ Quick-Connect Ergo Adjustable Handle	81	86876174816
FGQ76500YL00	Yellow	4"–8" HYGEN™ Quick-Connect Extension Pole	81	86876201017
FGQ77000YL00	Yellow	6"–12" HYGEN™ Quick-Connect Extension Pole	81	86876201024
FGQ77500YL00	Yellow	6"–18" HYGEN™ Quick-Connect Extension Pole	81	86876201116
FGQ80000WH00	White	18" (45.7 cm) Microfiber Finish Pad	90	86876173710
FGQ80500WH00	White	FLOW™ Nylon Flat Mop	89	86876192377
FGQ81000YL00	Yellow	18" (45.7 cm) HYGEN™ Microfiber Super Scrubber Mop	79	86876173727
FGQ82000BL00	Blue	11" (27.9 cm) HYGEN™ Microfiber Wall/Stair Damp Mop	79	86876173741
FGQ85000BK00	Black	HYGEN™ Quick-Connect Flexible Dusting Wand with Microfiber Sleeve	86	86876174977
FGQ85100GR00	Green	HYGEN™ Wand Duster Microfiber Replacement Sleeve	86	86876174984
FGQ85200WH00	White	Executive 22" HYGEN™ Multipurpose Flexible Microfiber Duster and Frame	86	86876200942
FGQ85300WH00	White	Executive 22" HYGEN™ Multipurpose Flexible Microfiber Duster	86	86876200959
FGQ85500BK00	Black	11" HYGEN™ Microfiber Flexi-Frame	77	86876200898
FGQ85600GR00	Green	HYGEN™ Microfiber Flexi-Frame Duster Cover	77	86876200904
FGQ86100WH00	White	11" HYGEN™ Microfiber Flexi-Frame Hi-Pile Cover	77	86876200911
FGQ87100BL00	Black	HYGEN™ Microfiber Flexi-Frame Glass Cover	77	86876201109
FGQ88100YL00	Yellow	HYGEN™ Microfiber Flexi-Frame Tub and Tile Cover	77	86876200928
FGQ89100BL00	Blue	HYGEN™ Microfiber Flexi-Frame Damp Mop Cover	77	86876201789
FGQ90088YEL	Yellow	HYGEN™ Press Wring Bucket	82	86876176827
FGQ93000BLUE	Blue	Finish Bucket	90	
FGQ95088YEL	Yellow	HYGEN™ Changing Bucket	82	86876206418
FGQ966000000		HYGEN™ PULSE™ Caddy	83	86876192360
FGQ966000000		Rubbermaid PULSE™ Caddy	85	86876192360
FGQ977000000		FLOW™ Replacement Bladder	89	86876192391
FGQ97900YL00	Yellow	FLOW™ Flat Mop Finish Kit	89	86876192346
FGR1012EBK	Black	Smokers' Station® Wall-Mount Urn w/ Keyed Cam Lock	65	97591027042
FGR1012SS	Stainless Steel	Smokers' Station® Wall-Mount Urn w/ Keyed Cam Lock	65	97591027004

PART NO.	Color	DESCRIPTION	PAGE	UPC
FGR12SU201PL	Brown Gloss Trim w/ Brown Panels	Ash/Trash 45L/12G	58	97591028575
FGR1536EGLBK	Black Gloss	Push Door 56L/15G	53	97591059418
FGR1536EOTGLBK	Black Gloss	Dome Top 56L/15G	40	97591107089
FGR1536EOTPLBK	Black Gloss	Dome Top 56L/15G	40	97591105351
FGR1536EPLBK	Black Gloss	Push Door 56L/15G	53	97591061763
FGR1536MCGL	Mirror Chrome	Push Door 56L/15G	53	97591058503
FGR1536MCPL	Mirror Chrome	Push Door 56L/15G	53	97591060858
FGR1536SSSGL	Stainless Steel	Push Door 56L/15G	53	97591011065
FGR1536SSSPL	Stainless Steel	Push Door 56L/15G	53	97591011157
FGR1639EHBZ	Hammertone Bronze	Aladdin Smokers' Station®	69	
FGR1639EHGR	Hammertone Charcoal	Aladdin Smokers' Station®	69	
FGR18SU201PL	Brown Gloss Trim w/ Brown Panels	Ash/Trash 90L/24G	58	97591065761
FGR18WU500PL	Black Gloss w/ Anthracite Metallic Perf Panels	Ash/Trash Weather Shield 90L/24G	58	97591107911
FGR1BK	Black	Smokers' Pole	69	97591109113
FGR1SM	Silver Metallic	Smokers' Pole	69	97591109106
FGR2030EPLBK	Black Gloss	Eclipse Open Top Metal Refuse	57	97591123928
FGR2030SSPL	Stainless Steel	Eclipse Open Top Metal Refuse	57	97591121856
FGR32EGLBK	Black Gloss	Open Top 56L/15G	27	97591055717
FGR32EGLWH	Sky White Gloss	Open Top 56L/15G	27	97591055663
FGR32SSSGL	Stainless Steel	Open Top 56L/15G	27	97591010990
FGR36HT201PL	Brown Gloss Trim w/ Brown Panels	Hinged Top 109L/29G	58	97591024607
FGR36HT500PL	Black Gloss w/ Anthracite Metallic Perf Panels	Hinged Top 109L/29G	58	97591106204
FGR38HT201PL	Brown Gloss Trim w/ Brown Panels	Hinged Top 143L/38G	58	97591025710
FGR38HT500PL	Black Gloss w/ Anthracite Metallic Perf Panels	Hinged Top 143L/38G	58	97591106242
FGR48HT201PL	Brown Gloss Trim w/ Brown Panels	Hinged Top 181L/48G	58	97591001288
FGR48HT500PL	Black Gloss w/ Anthracite Metallic Perf Panels	Hinged Top 181L/48G	58	97591106259
FGR93400BK	Black	Metropolitan Smokers' Station	68	86876194371
FGR93400SM	Silver Metallic	Metropolitan Smokers' Station	68	86876194388
FGS21600GY00	Gray	Wall Washer Kit Includes 1 Wood Handle, 1 Plastic Head, 2 Cotton Pads	132	86876126006
FGS22600GY00	Gray	Wall Washer Kit Includes 1 Aluminum Handle, 1 Plastic Head, 2 Cotton Pads	132	86876125634
FGS25		White Silica Sand, five 5-lb Bags	70	
FGS29900WH00	White	Wall Washer Replacement Pads, Launderable Cotton	132	86876126020
FGS3ETBKPL	Black Gloss	Open Top 94L/25G	50	97591106686
FGS3ETHBZPL	Textured Bronze	Open Top 94L/25G	50	97591103791
FGS3ETSMPLBK	Stardust Silver Metallic w/ Black Lid	Open Top 94L/25G	50	97591108314
FGS3SSSSPL	Stainless Steel	Open Top 94L/25G	50	97591107034
FGS55ETBKPL	Textured Black	Open Top 193L/51G	50	97591106693

PART NO.	Color	DESCRIPTION	PAGE	UPC
FGS55ETSMPLBK	Stardust Silver Metallic w/ Black Lid	Open Top 193L/51G	50	97591113608
FGS55SSTSSPL	Stainless Steel	Open Top 193L/51G	50	97591107126
FGSBR52BK	Black	Street Basket	64	97591101254
FGSBR52	Galvanized Steel	Street Basket	64	97591101254
FGSC10ERBTBK	Textured Black	Square Open Top 37L/10G	14	97591107195
FGSC14EPLTBK	Textured Black	Square Open Top 60L/16G	14	97591107256
FGSC14ERBTBK	Textured Black	Square Open Top 90L/24G	14	97591107232
FGSC14SSPL	Stainless Steel	Square Open Top 60L/16G	14	97591107263
FGSC14SSRB	Stainless Steel	Square Open Top 90L/24G	14	97591107249
FGSC18EPLSM	Stardust Silver Metallic	Square Open Top 75L/20G	14	97591123331
FGSC18EPLTBK	Textured Black	Square Open Top 75L/20G	14	97591107294
FGSC18ERBDP	Desert Pearl	Square Open Top 109L/29G	14	97591123324
FGSC18ERBSM	Stardust Silver Metallic	Square Open Top 109L/29G	14	97591123348
FGSC18ERBTBK	Textured Black	Square Open Top 109L/29G	14	97591107270
FGSC18SSPL	Stainless Steel	Square Open Top 75L/20G	14	97591107300
FGSC18SSRB	Stainless Steel	Square Open Top 109L/29G	14	97591107287
FGSC22EPLSM	Stardust Silver Metallic	Square Open Top 151L/40G	14	97591123379
FGSC22EPLTBK	Textured Black	Square Open Top 151L/40G	14	97591123416
FGSC22ERBDP	Desert Pearl	Square Open Top 189L/50G	14	97591123409
FGSC22ERBSM	Stardust Silver Metallic	Square Open Top 189L/50G	14	97591123386
FGSC22ERBTBK	Textured Black	Square Open Top 189L/50G	14	97591123423
FGSC22SSPL	Stainless Steel	Square Open Top 151L/40G	14	97591123355
FGSC22SSRB	Stainless Steel	Square Open Top 189L/50G	14	97591123362
FGSCSUSS	Stainless Steel	Square Sand Urn	15	97591107188
FGSCSUTBK	Textured Black	Square Sand Urn	15	97591107171
FGSH12EPLSM	Stardust Silver Metallic	Open Top 45L/12G	54	97591123232
FGSH12EPLTBK	Textured Black	Open Top 45L/12G	54	97591123256
FGSH12SSPL	Stainless Steel	Open Top 45L/12G	54	97591123263
FGSO1220PLBK	Black Gloss w/ Chrome Trim	Open Top 45L/12G	54	97591123218
FGSO12SSSPL	Stainless Steel	Open Top 45L/12G	54	97591123225
FGSO16SSSGL	Stainless Steel	Flat Top 45L/12G	54	97591010754
FGSO16SUSSSGL	Stainless Steel	Ash/Trash 45L/12G	54	97591010839
FGSO820PLANT	Anthracite w/ Chrome Trim	Flat Top 34L/9G	54	97591101124
FGSO820PLBK	Black Gloss w/ Chrome Trim	Flat Top 34L/9G	54	97591041093
FGSO8SSSPL	Stainless Steel	Flat Top 34L/9G	54	97591104293
FGSO8SU20PLBK	Black Gloss w/ Chrome Trim	Ash/Trash 34L/9G	54	97591011980
FGSO8SUSSSPL	Stainless Steel	Ash/Trash 34L/9G	54	97591104309
FGSR14EPLSM	Stardust Silver Metallic	Small Rectangle 49L/13G	51	97591123430
FGSR14EPLTBK	Textured Black	Small Rectangle 49L/13G	51	97591110614
FGSR14ERBDP	Desert Pearl	Small Rectangle 94L/25G	51	97591123461
FGSR14ERBSM	Stardust Silver Metallic	Small Rectangle 94L/25G	51	97591123447
FGSR14ERBTBK	Textured Black	Small Rectangle 94L/25G	51	97591110553
FGSR14SSPL	Stainless Steel	Small Rectangle 49L/13G	51	97591110621
FGSR14SSRB	Stainless Steel	Small Rectangle 94L/25G	51	97591110577
FGSR18EPLSM	Stardust Silver Metallic	Large Rectangle 85L/22.5G	51	97591123478
FGSR18EPLTBK	Textured Black	Large Rectangle 85L/22.5G	51	97591110652
FGSR18ERBDP	Desert Pearl	Large Rectangle 151L/40G	51	97591123508
FGSR18ERBSM	Stardust Silver Metallic	Large Rectangle 151L/40G	51	97591123485
FGSR18ERBTBK	Textured Black	Large Rectangle 151L/40G	51	97591110638
FGSR18SSPL	Stainless Steel	Large Rectangle 85L/22.5G	51	97591110669
FGSR18SSRB	Stainless Steel	Large Rectangle 151L/40G	51	97591110645
FGSSIG		Smokers' Station® Wall-Mount In-Ground Pole w/ Hardware For Fgr1012	65	97591034057

PART NO.	Color	DESCRIPTION	PAGE	UPC
FGSSSM		Smokers' Station® Wall-Mount/ Surface-Mount Pole w/ Hardware For Fgr1012	65	97591034200
FGST12EPLRD	Red Gloss	Square Step Can 45L/12G	52	97591001233
FGST12EPLWH	Sky White Gloss	Square Step Can 45L/12G	52	97591074053
FGST12ERBRD	Red Gloss	Square Step Can 45L/12G	52	97591074329
FGST12ERBWH	Sky White Gloss	Square Step Can 45L/12G	52	97591074039
FGST12SSPL	Stainless Steel	Square Step Can 45L/12G	52	97591074022
FGST12SSRB	Stainless Steel	Square Step Can 45L/12G	52	97591074008
FGST24EPLRD	Red Gloss	Square Step Can 90L/24G	52	97591002469
FGST24EPLWH	Sky White Gloss	Square Step Can 90L/24G	52	97591074114
FGST24ERBRD	Red Gloss	Square Step Can 90L/24G	52	97591073988
FGST24ERBWH	Sky White Gloss	Square Step Can 91L/24G	52	97591074091
FGST24SSPL	Stainless Steel	Square Step Can 90L/24G	52	97591074084
FGST24SSRB	Stainless Steel	Square Step Can 91L/24G	52	97591074060
FGST40EPLRD	Red Gloss	Square Step Can 151L/40G	52	97591002452
FGST40EPLRD	Red Gloss	Square Step Can w/ Wheels 151L/40G	52	97591002452
FGST40EPLWH	Sky White Gloss	Square Step Can 151 L/40 G	52	97591074176
FGST40ERBRD	Red Gloss	Square Step Can 151L/40G	52	97591074336
FGST40ERBRD	Red Gloss	Square Step Can w/ Wheels 151L/40G	52	97591074336
FGST40ERBWH	Sky White Gloss	Square Step Can w/ Wheels 151L/40G	52	97591073902
FGST7EPLRD	Red Gloss	Square Step Can 26L/7G	52	97591006450
FGST7EPLWH	Sky White Gloss	Square Step Can 26L/7G	52	97591073728
FGST7ERBRD	Red Gloss	Square Step Can 26L/7G	52	97591005743
FGST7ERBWH	Sky White Gloss	Square Step Can 26L/7G	52	97591073711
FGST7SSPL	Stainless Steel	Square Step Can 26L/7G	52	
FGST7SSRB	Stainless Steel	Square Step Can 26L/7G	52	
FGT11000GY00	Gray	Overhead Dusting Tool with Launderable Head, 51" I (129.5 cm) Extension Handle	125	86876125894
FGT12000GY00	Gray	Overhead Dusting Tool with Angled Launderable Head, 51" I (129.5 cm) Extension Handle	125	86876125931
FGT13000GY00	Gray	Overhead Dusting Tool with Launderable Head, 8 1/2" I (2.6 m) Extension Handle	125	86876125955
FGT19900WH00	White	Overhead Dusting Tool Replacement Head fits FGT11000, FGT12000, FGT13000	125	86876125979
FGT20006WH00	White	Nylon Finish Mop	114	86876149203
FGT20106WH00	White	Nylon Finish Mop	114	86876149210
FGT25500WH00	White	Rough-Floor Wet Mop	114	86876161892
FGT25600WH00	White	Rough-Floor Wet Mop	114	86876161908
FGT30000WH00	White	Clean Room Mop	114	86876144390
FGT30100WH00	White	Clean Room Mop	114	86876153361
FGT410000000		Flexible-Head Overhead Dusting Tool, Flexible Head with 60" I (152.4 cm) Aluminum Handle	125	86876050905
FGT81206GR00	Green	Web Foot® Microfiber Tube Mop	103	86876201222
FGT81306GR00	Green	Web Foot® Microfiber Tube Mop	103	86876201239
FGT85206GR00	Green	Web Foot® Microfiber Tube Mop	103	86876201246
FGT85306GR00	Green	Web Foot® Microfiber Tube Mop	103	86876201253
FGU110000000		Wedge Mop Handle and Frame, Wood Handle with Metal Frame	123	86876047929
FGU12000YL00	Yellow	Trapper® Wedge Mop Dust Mop Head, Looped-End	123	86876145113

UTILITY AND RECYCLING REFUSE

DECORATIVE REFUSE

CLEANING

MATERIAL HANDLING

WASHROOM

FOODSERVICE

ACCESSORIES & INDEX



UTILITY AND
RECYCLING REFUSE

DECORATIVE REFUSE

CLEANING

MATERIAL HANDLING

WASHROOM

FOODSERVICE

ACCESSORIES
& INDEX

PART NO.	Color	DESCRIPTION	PAGE	UPC
FGU13000WH00	White	Kut-A-Way® Wedge Mop Dust Mop Head, Cut-End	123	86876144376
FGU13067WH00	White	Kut-A-Way® Wedge Mop Kit, Contains FGU13000 Mop, FGU11000 Handle, and Frame	123	86876147889
FGU21000WH00		Laundry Net, Synthetic Mesh Bag with Locking Closure	116	
FGU650SA	Satin Aluminum	Smokers' Station® Wall-Mount Urn	65	97591012109
FGV11600WH00	White	Economy Cotton Cut-End Mop	112	86876045994
FGV11700WH00	White	Economy Cotton Cut-End Mop	112	86876046007
FGV11800WH00	White	Economy Cotton Cut-End Mop	112	86876046014
FGV11900WH00	White	Economy Cotton Cut-End Mop	112	86876046021
FGV15600WH00	White	Economy Cotton Cut-End Mop	112	86876050998
FGV15700WH00	White	Economy Cotton Cut-End Mop	112	86876051001
FGV15800WH00	White	Economy Cotton Cut-End Mop	112	86876051018
FGV15900WH00	White	Economy Cotton Cut-End Mop	112	86876051025
FGV41600WH00	White	Economy Rayon Cut-End Mop	112	86876051049
FGV41700WH00	White	Economy Rayon Cut-End Mop	112	86876045901
FGV41800WH00	White	Economy Rayon Cut-End Mop	112	86876045918
FGV41900WH00	White	Economy Rayon Cut-End Mop	112	86876051056
FGWB2029GR	Green	Steel Wastebasket Open Top	42	97591087800
FGWB26AL	Almond	Steel Wastebasket Open Top	42	97591042144
FGWB26BK	Black	Steel Wastebasket Open Top	42	97591086339
FGWB26GR	Green	Steel Wastebasket Open Top	42	97591085851
FGWB29RSS	Stainless Steel	Concept Collection™ Open-Top Wastebasket	39	97591106228
FGWB30RAL	Almond	Steel Wastebasket Open Top	42	97591042151
FGWB30RGR	Green	Steel Wastebasket Open Top	42	97591086360
FGWB96RAL	Almond	Steel Wastebasket Open Top	42	97591042168
FGWB96RBK	Black	Steel Wastebasket Open Top	42	97591087183
FGWHB14EBK	Black	Hide-a-Bag Open-Top Wastebasket, Black	39	97591109038
FGWHB14SS	Stainless Steel	Hide-a-Bag Open-Top Wastebasket, Stainless	39	97591109045
FGWMB20BK	Black	Concept Collection™ Open-Top Wastebasket	39	97591080061
FGWMB30RBK	Black	Concept Collection™ Open-Top Wastebasket	39	97591011324
FGWU		Weather Urn Top	70	
FGWU		Weather Urn Top	70	
FGWU1		Weather Urn Tops	70	
FGWU3		Weather Urn Tops	70	
FGY16R		Mechanical Portion Control Scale	235	77177035357
FGY32R		Mechanical Portion Control Scale	235	77177035333
FGYG180R		Mechanical Portion Control Scale	235	77177035210
FGYG425R		Mechanical Portion Control Scale	235	77177035418
FGYG450R		Mechanical Portion Control Scale	235	77177035524
M1564200		Wheel for FG564200, FG564261	186	86876173819
M1566000		Wheel for FG566061	186	86876173970

COMPONENT PART	COMPONENT DESCRIPTION	FITS	PAGE # (OF 'FITS' SKU)
1790072	Glutton® 1-Stream Recycling Insert, Green	1792373	41
1791803	SRP Endcaps with 2 Screws, Black	FGQ55000YL00	81
1791803	SRP Endcaps with 2 Screws, Black	FGQ56000YL00	81
1791803	SRP Endcaps with 2 Screws, Black	FGQ58000YL00	283
1791803	SRP Endcaps with 2 Screws, Black	FGQ59000YL00	283
FG1005L40000	3.5" Casters with Hardware	FG130500BLA	165
FG1005L40000	3.5" Casters with Hardware	FG130500BLU	165
FG1005L40000	3.5" Casters with Hardware	FG130500RED	165
FG1005L40000	3.5" Casters with Hardware	FG130500YEL	165
FG1005L40000	3.5" Casters with Hardware	FG130573BLU	165
FG1005L40000	3.5" Casters with Hardware	FG130600BLA	165
FG1011L10000	12" Wheel with Hardware	FG101100BLA	164
FG1011L20000	4" Caster with Hardware	FG101100BLA	164
FG1013L10000	12" Wheel with Hardware	FG101300BLA	164
FG1013L20000	4" Caster with Hardware	FG101300BLA	164
FG1013L20000	4" Caster with Hardware	FG9T1400BLA	164
FG1014L30000	12" Wheel with Hardware	FG131400BLA	165
FG1025L40000	4" Swivel Caster with Hardware	FG102500BLA	165
FG1025L40000	4" Swivel Caster with Hardware	FG102600BLA	165
FG1025L40000	4" Swivel Caster with Hardware	FG103500BLA	165
FG1025L40000	4" Swivel Caster with Hardware	FG103600BLA	165
FG1025L40000	4" Swivel Caster with Hardware	FG104500BLA	165
FG1025L40000	4" Swivel Caster with Hardware	FG104600BLA	165
FG1025LSBLA	Frame Assembly for Tilt Truck, Black	FG102500BLA	165
FG1025LSRED	Frame Assembly for Tilt Truck, Red	FG102500BLA	165
FG1026LSBLA	Frame Assembly for Tilt Truck, Black	FG102600BLA	165
FG1026LSRED	Frame Assembly for Tilt Truck, Red	FG102600BLA	165
FG1026L60000	12" Wheel with Hardware	FG103500BLA	165
FG1026L60000	12" Wheel with Hardware	FG103600BLA	165
FG1026L60000	12" Wheel with Hardware	FG104500BLA	165
FG1026L60000	12" Wheel with Hardware	FG104600BLA	165
FG1035LSBLA	Frame Assembly for Tilt Truck, Black	FG103500BLA	165
FG1035LSRED	Frame Assembly for Tilt Truck, Red	FG103500BLA	165
FG1045LSBLA	Frame Assembly for Tilt Truck, Black	FG104500BLA	165
FG1045LSRED	Frame Assembly for Tilt Truck, Red	FG104500BLA	165
FG1046LSRED	Frame Assembly for Tilt Truck, Red	FG104600BLA	165
FG1054L40000	6" Swivel Caster with Hardware	FG105943BLA	167
FG1054L40000	6" Swivel Caster with Hardware	FG107443BLA	167
FG1054L50000	6" Rigid Caster with Hardware	FG107443BLA	167
FG1304L2RED	Frame Assembly for Tilt Truck, Red	FG130400BLA	165
FG1304L30000	4" Swivel Threaded Caster	FG130400BLA	165
FG1305L2BLA	Frame Assembly for Tilt Truck, Black	FG130500BLA	165
FG1305L2BLA	Frame Assembly for Tilt Truck, Black	FG130500DBLUE	165
FG1305L2BLA	Frame Assembly for Tilt Truck, Black	FG130500RED	165
FG1305L2BLA	Frame Assembly for Tilt Truck, Black	FG130500YEL	165

COMPONENT PART	COMPONENT DESCRIPTION	FITS	PAGE # (OF 'FITS' SKU)
FG1305L2BLA	Frame Assembly for Tilt Truck, Black	FG130600BLA	165
FG1305L2RED	Frame Assembly for Tilt Truck, Red	FG130500BLA	165
FG1305L2RED	Frame Assembly for Tilt Truck, Red	FG130500DBLUE	165
FG1305L2RED	Frame Assembly for Tilt Truck, Red	FG130500RED	165
FG1305L2RED	Frame Assembly for Tilt Truck, Red	FG130500YEL	165
FG1305L2RED	Frame Assembly for Tilt Truck, Red	FG130600BLA	165
FG1305L4BLA	1/2 & 1 cu yd Tilt Truck Handle, Black	FG130500BLA	165
FG1305L4BLA	1/2 & 1 cu yd Tilt Truck Handle, Black	FG130500DBLUE	165
FG1305L4BLA	1/2 & 1 cu yd Tilt Truck Handle, Black	FG130500RED	165
FG1305L4BLA	1/2 & 1 cu yd Tilt Truck Handle, Black	FG130542BLA	166
FG1305L4BLA	1/2 & 1 cu yd Tilt Truck Handle, Black	FG130573BLUE	165
FG1305L4BLA	1/2 & 1 cu yd Tilt Truck Handle, Black	FG130600BLA	165
FG1305L4BLA	1/2 & 1 cu yd Tilt Truck Handle, Black	FG130641BLA	166
FG1305L4BLA	1/2 & 1 cu yd Tilt Truck Handle, Black	FG131400BLA	165
FG1305L4BLA	1/2 & 1 cu yd Tilt Truck Handle, Black	FG131500BLA	165
FG1305L4BLA	1/2 & 1 cu yd Tilt Truck Handle, Black	FG131500DBLUE	165
FG1305L4BLA	1/2 & 1 cu yd Tilt Truck Handle, Black	FG131500RED	165
FG1305L4BLA	1/2 & 1 cu yd Tilt Truck Handle, Black	FG131500YEL	165
FG1305L4BLA	1/2 & 1 cu yd Tilt Truck Handle, Black	FG131600BLA	165
FG1305L4RED	1/2 & 1 cu yd Tilt Truck Handle, Red	FG130500BLA	165
FG1305L4RED	1/2 & 1 cu yd Tilt Truck Handle, Red	FG130500DBLUE	165
FG1305L4RED	1/2 & 1 cu yd Tilt Truck Handle, Red	FG130500RED	165
FG1305L4RED	1/2 & 1 cu yd Tilt Truck Handle, Red	FG130542BLA	166
FG1305L4RED	1/2 & 1 cu yd Tilt Truck Handle, Red	FG130573BLUE	165
FG1305L4RED	1/2 & 1 cu yd Tilt Truck Handle, Red	FG130600BLA	165
FG1305L4RED	1/2 & 1 cu yd Tilt Truck Handle, Red	FG130641BLA	166
FG1305L4RED	1/2 & 1 cu yd Tilt Truck Handle, Red	FG131400BLA	165
FG1305L4RED	1/2 & 1 cu yd Tilt Truck Handle, Red	FG131500BLA	165
FG1305L4RED	1/2 & 1 cu yd Tilt Truck Handle, Red	FG131500DBLUE	165
FG1305L4RED	1/2 & 1 cu yd Tilt Truck Handle, Red	FG131500RED	165
FG1305L4RED	1/2 & 1 cu yd Tilt Truck Handle, Red	FG131500YEL	165
FG1305L4RED	1/2 & 1 cu yd Tilt Truck Handle, Red	FG131600BLA	165
FG1314L2BLA	Frame Assembly for Tilt Truck, Black	FG131400BLA	165
FG1314L30000	5" Swivel Threaded Caster	FG131400BLA	165
FG1315L2BLA	Frame Assembly for Tilt Truck, Black	FG131500BLA	165
FG1315L2BLA	Frame Assembly for Tilt Truck, Black	FG131500DBLUE	165
FG1315L2BLA	Frame Assembly for Tilt Truck, Black	FG131500RED	165

COMPONENT PART	COMPONENT DESCRIPTION	FITS	PAGE # (OF 'FITS' SKU)
FG1315L2BLA	Frame Assembly for Tilt Truck, Black	FG131600BLA	165
FG1315L2RED	Frame Assembly for Tilt Truck, Red	FG131500BLA	165
FG1315L2RED	Frame Assembly for Tilt Truck, Red	FG131500DBLUE	165
FG1315L2RED	Frame Assembly for Tilt Truck, Red	FG131500RED	165
FG1315L2RED	Frame Assembly for Tilt Truck, Red	FG131600BLA	165
FG1315L30000	12" Wheel for 1 cu yd Tilt Truck	FG131500BLA	165
FG1315L30000	12" Wheel for 1 cu yd Tilt Truck	FG131500DBLUE	165
FG1315L30000	12" Wheel for 1 cu yd Tilt Truck	FG131500RED	165
FG1315L30000	12" Wheel for 1 cu yd Tilt Truck	FG131500YEL	165
FG1315L30000	12" Wheel for 1 cu yd Tilt Truck	FG9T1500BLA	164
FG1316L4RED	Hitch For Towable Trainable Tile Truck, Red	FG131641BLA	166
FG1316L4RED	Hitch For Towable Trainable Tile Truck, Red	FG472741BLA	168
FG2523L10000	Step Stool Caster	FG252300BEIG	284
FG2523L10000	Step Stool Caster	FG252300BLA	284
FG2523L3BLA	Step Stool Step Pad, Black	FG252300BEIG	284
FG2531L4BLA	Lobby Pro® Dust Pan Wheels, Black	FG253100BLA	129
FG2532L1BLA	Lobby Pro® Dust Pan Cover, Black	FG253200BLA	129
FG2532L2BLA	Lobby Pro® Handle, Black	FG253200BLA	129
FG2532L3BLA	Lobby Pro® Pan, Black	FG253300BLA	129
FG256RL2DGRN	Glutton® Square Insert, Dark Green	1792339	41
FG256RL2DGRN	Glutton® Square Insert, Dark Green	1792340	41
FG256RL2DGRN	Glutton® Square Insert, Dark Green	1792371	41
FG256RL2DGRN	Glutton® Square Insert, Dark Green	1792372	41
FG256RL2DGRN	Glutton® Square Insert, Dark Green	1792373	41
FG256RL2DGRN	Glutton® Square Insert, Dark Green	1792374	41
FG256RL3DGRN	Glutton® Paper Insert, Dark Green	1792339	41
FG256RL3DGRN	Glutton® Paper Insert, Dark Green	1792340	41
FG256RL3DGRN	Glutton® Paper Insert, Dark Green	1792372	41
FG256RL3DGRN	Glutton® Paper Insert, Dark Green	1792373	41
FG256RL4DGRN	Glutton® Circle Insert, Dark Green	1792339	41
FG256RL4DGRN	Glutton® Circle Insert, Dark Green	1792340	41
FG256RL4DGRN	Glutton® Circle Insert, Dark Green	1792371	41
FG256RL4DGRN	Glutton® Circle Insert, Dark Green	1792372	41
FG256RL4DGRN	Glutton® Circle Insert, Dark Green	1792373	41
FG256RL4DGRN	Glutton® Circle Insert, Dark Green	1792374	41
FG256RL5DGRN	Glutton® Triangle Insert, Dark Green	1792339	41
FG256RL5DGRN	Glutton® Triangle Insert, Dark Green	1792340	41
FG256RL5DGRN	Glutton® Triangle Insert, Dark Green	1792371	41
FG256RL5DGRN	Glutton® Triangle Insert, Dark Green	1792372	41

UTILITY AND RECYCLING REFUSE

DECORATIVE REFUSE

CLEANING

MATERIAL HANDLING

WASHROOM

FOODSERVICE

ACCESSORIES & INDEX



COMPONENT PART	COMPONENT DESCRIPTION	FITS	PAGE # (OF 'FITS' SKU)
FG256RL5DGRN	Glutton® Triangle Insert, Dark Green	1792373	41
FG256RL5DGRN	Glutton® Triangle Insert, Dark Green	1792374	41
FG2570L4BEIG	Replacement GroundsKeeper® Receptacle, Beige	FG257088BEIG	284
FG2570L4BEIG	Replacement GroundsKeeper® Receptacle, Beige	FG257088BLA	284
FG2570L4BEIG	Replacement GroundsKeeper® Receptacle, Beige	FG9W3000BLA	284
FG2570L4BEIG	Replacement GroundsKeeper® Receptacle, Beige	FG9W3000SSTON	284
FG2570L4BLA	Replacement GroundsKeeper® Receptacle, Black	FG257088BEIG	284
FG2570L4BLA	Replacement GroundsKeeper® Receptacle, Black	FG257088BLA	284
FG2570L4BLA	Replacement GroundsKeeper® Receptacle, Black	FG257088BRN	284
FG2570L4BLA	Replacement GroundsKeeper® Receptacle, Black	FG9W3000BLA	284
FG2570L4BLA	Replacement GroundsKeeper® Receptacle, Black	FG9W3000SSTON	284
FG2570L4BRN	Replacement GroundsKeeper® Receptacle, Brown	FG257088BEIG	284
FG2570L4BRN	Replacement GroundsKeeper® Receptacle, Brown	FG257088BLA	284
FG2570L4BRN	Replacement GroundsKeeper® Receptacle, Brown	FG9W3000BLA	284
FG2570L4BRN	Replacement GroundsKeeper® Receptacle, Brown	FG9W3000SSTON	284
FG2586L1BLA	Smoking Urn Metal Liner, Black	FG258600BLA	80
FG2650L10000	3" Plastic Dolly Caster	FG265000BLA	94
FG2664L1BEIG	Untouchable® Square Swing Top Replaceable Doors, Beige	FG266400BEIG	113
FG2664L1BEIG	Untouchable® Square Swing Top Replaceable Doors, Beige	FG266400GRAY	113
FG2664L1GRAY	Untouchable® Square Swing Top Replaceable Doors, Gray	FG266400BEIG	113
FG2779L1BEIG	Untouchable® Round Swing Top Replaceable Door, Beige	FG267200BEIG	113
FG3316L2WHT	Replacement Cutting Board, White	FG331600BLA	319
FG3421L60000	3" Caster Kit (4)	FG342100BLA	233
FG3421L60000	3" Caster Kit (4)	FG9T6571BEIG	233
FG3424L60000	4" Swivel Caster with Insert	FG335588PLAT	233
FG3424L60000	4" Swivel Caster with Insert	FG342488BLA	233
FG3424L60000	4" Swivel Caster with Insert	FG342488OWHT	233
FG3424L60000	4" Swivel Caster with Insert	FG342488PLAT	233
FG3424L60000	4" Swivel Caster with Insert	FG342488RED	233
FG3424L60000	4" Swivel Caster with Insert	FG345700BLA	233
FG3424L60000	4" Swivel Caster with Insert	FG409100BLA	234
FG3424L60000	4" Swivel Caster with Insert	FG409100BLA	234
FG3424L60000	4" Swivel Caster with Insert	FG409100GRAY	234
FG3424L60000	4" Swivel Caster with Insert	FG409100GRAY	234
FG3424L60000	4" Swivel Caster with Insert	FG409100OWHT	234
FG3424L60000	4" Swivel Caster with Insert	FG409100OWHT	234
FG3424L60000	4" Swivel Caster with Insert	FG409300BLA	234
FG3424L60000	4" Swivel Caster with Insert	FG409300OWHT	234
FG3424L60000	4" Swivel Caster with Insert	FG409400GRAY	234
FG3424L60000	4" Swivel Caster with Insert	FG409400GRAY	234
FG3424L60000	4" Swivel Caster with Insert	FG409500BLA	234
FG3424L60000	4" Swivel Caster with Insert	FG9T6800BLA	232
FG3424L60000	4" Swivel Caster with Insert	FG9T7200BLA	193
FG3424L60000	4" Swivel Caster with Insert	FG9T7300BLA	192
FG3424L60000	4" Swivel Caster with Insert	FG9T7400BLA	192
FG3424L60000	4" Swivel Caster with Insert	FG9T7800BLA	195
FG3530L10000	3" Swivel Caster with Stem and Hardware	FG264000BLA	94
FG3530L10000	3" Swivel Caster with Stem and Hardware	FG353000BLA	94

COMPONENT PART	COMPONENT DESCRIPTION	FITS	PAGE # (OF 'FITS' SKU)
FG3559L30000	Axle for BRUTE® Rollout Containers	1829410	99
FG3559L30000	Axle for BRUTE® Rollout Containers	1829411	99
FG3559L30000	Axle for BRUTE® Rollout Containers	FG9W2700BLUE	99
FG3559L30000	Axle for BRUTE® Rollout Containers	FG9W2700GRAY	99
FG3559L30000	Axle for BRUTE® Rollout Containers	FG9W2773BLUE	100
FG3964L30000	Plaza® Container Latch Kit	FG396400BEIG	75
FG3964L30000	Plaza® Container Latch Kit	FG396400BLA	75
FG3964L30000	Plaza® Container Latch Kit	FG396500BEIG	75
FG3964L50000	Plaza® Container Hardware Kit	FG396400BEIG	75
FG3964L50000	Plaza® Container Hardware Kit	FG396400BLA	75
FG3964L50000	Plaza® Container Hardware Kit	FG396400DGRN	75
FG3964L50000	Plaza® Container Hardware Kit	FG396500BEIG	75
FG3964L60000	Plaza® Container Lock & Key	FG396300BEIG	75
FG3964L60000	Plaza® Container Lock & Key	FG396300BLA	75
FG3964L60000	Plaza® Container Lock & Key	FG396400BEIG	75
FG3964L60000	Plaza® Container Lock & Key	FG396400BLA	75
FG3964L60000	Plaza® Container Lock & Key	FG396400DGRN	75
FG3964L60000	Plaza® Container Lock & Key	FG396500BEIG	75
FG3964L60000	Plaza® Container Lock & Key	FG396900DGRN	117
FG3964L60000	Plaza® Container Lock & Key	FG9P9000BEIG	75
FG3964L60000	Plaza® Container Lock & Key	FG9P9000BLA	75
FG3964L60000	Plaza® Container Lock & Key	FG9P9000DGRN	75
FG3965L10000	Plaza® Container Ash Tray Kit	FG396500BEIG	75
FG3965L10000	Plaza® Container Ash Tray Kit	FG9P9100BLA	75
FG3970L40000	Landmark Series® Lock & Keys	FG397000BLA	73
FG3970L40000	Landmark Series® Lock & Keys	FG397000DWOOD	73
FG3970L40000	Landmark Series® Lock & Keys	FG397500BLA	76
FG3970L40000	Landmark Series® Lock & Keys	FG397500DWOOD	76
FG3970L40000	Landmark Series® Lock & Keys	FG397500SBLE	76
FG3972L20000	Hardware Kit	FG397000BLA	73
FG3972L20000	Hardware Kit	FG397000DWOOD	73
FG3972L20000	Hardware Kit	FG397001BLA	73
FG3972L20000	Hardware Kit	FG397001DWOOD	73
FG3972L20000	Hardware Kit	FG397001SBLE	73
FG3972L20000	Hardware Kit	FG397088BLA	73
FG3972L20000	Hardware Kit	FG397100DWOOD	73
FG3972L20000	Hardware Kit	FG397100SBLE	73
FG3972L20000	Hardware Kit	FG397200SBLE	73
FG3972L20000	Hardware Kit	FG397500BLA	76
FG3972L20000	Hardware Kit	FG397500DWOOD	76
FG3972L20000	Hardware Kit	FG397500SBLE	76
FG3972L20000	Hardware Kit	FG397501BLA	76
FG3972L20000	Hardware Kit	FG397501DWOOD	76
FG3972L20000	Hardware Kit	FG397501SBLE	76
FG3975L1BLA	Landmark Series® Dome Top Replacement, Black	FG397000BLA	73
FG3975L1BLA	Landmark Series® Dome Top Replacement, Black	FG397000DWOOD	73
FG3975L1BLA	Landmark Series® Dome Top Replacement, Black	FG397500BLA	76
FG3975L1BLA	Landmark Series® Dome Top Replacement, Black	FG397500DWOOD	76
FG3975L1BLA	Landmark Series® Dome Top Replacement, Black	FG397500SBLE	76
FG3975L1DWOOD	Landmark Series® Dome Top Replacement, Driftwood	FG397000BLA	73
FG3975L1DWOOD	Landmark Series® Dome Top Replacement, Driftwood	FG397000DWOOD	73
FG3975L1DWOOD	Landmark Series® Dome Top Replacement, Driftwood	FG397500BLA	76
FG3975L1DWOOD	Landmark Series® Dome Top Replacement, Driftwood	FG397500DWOOD	76
FG3975L1DWOOD	Landmark Series® Dome Top Replacement, Driftwood	FG397500SBLE	76
FG3975L1SBLE	Landmark Series® Dome Top Replacement, Sable	FG397000BLA	73

COMPONENT PART	COMPONENT DESCRIPTION	FITS	PAGE # (OF 'FITS' SKU)
FG3975L1SBLE	Landmark Series® Dome Top Replacement, Sable	FG397000DWOOD	73
FG3975L1SBLE	Landmark Series® Dome Top Replacement, Sable	FG397500BLA	76
FG3975L1SBLE	Landmark Series® Dome Top Replacement, Sable	FG397500DWOOD	76
FG3975L1SBLE	Landmark Series® Dome Top Replacement, Sable	FG397500SBLE	76
FG3975L3DWOOD	Landmark Series® Stationary/ Moving Collar, Driftwood	FG397000BLA	73
FG3975L3DWOOD	Landmark Series® Stationary/ Moving Collar, Driftwood	FG397000DWOOD	73
FG3975L3DWOOD	Landmark Series® Stationary/ Moving Collar, Driftwood	FG397500BLA	76
FG3975L3DWOOD	Landmark Series® Stationary/ Moving Collar, Driftwood	FG397500DWOOD	76
FG3975L3DWOOD	Landmark Series® Stationary/ Moving Collar, Driftwood	FG397500SBLE	76
FG3975L3SBLE	Landmark Series® Stationary/ Moving Collar, Sable	FG397000BLA	73
FG3975L3SBLE	Landmark Series® Stationary/ Moving Collar, Sable	FG397000DWOOD	73
FG3975L3SBLE	Landmark Series® Stationary/ Moving Collar, Sable	FG397500BLA	76
FG3975L3SBLE	Landmark Series® Stationary/ Moving Collar, Sable	FG397500DWOOD	76
FG3975L3SBLE	Landmark Series® Stationary/ Moving Collar, Sable	FG397500SBLE	76
FG3975L6DWOOD	Landmark Series® Deco Leg	FG397500BLA	76
FG3975L6DWOOD	Landmark Series® Deco Leg	FG397500DWOOD	76
FG4094L1BLA	Door Kit with Lock for Xtra™ Cart, Black	FG409400GRAY	234
FG4094L1BLA	Door Kit with Lock for Xtra™ Cart, Black	FG409500BLA	234
FG4094L1LGRAY	Door Kit with Lock for Xtra™ Cart, Gray	FG409400GRAY	234
FG4094L1LGRAY	Door Kit with Lock for Xtra™ Cart, Gray	FG409500BLA	234
FG4401L10000	Caterer's Trolley Wheel Kit	FG440186BLA	318
FG4401L10000	Caterer's Trolley Wheel Kit	FG9F1600CGRAY	317
FG4402L10000	5" Rubber Swivel Caster	FG131500BLA	240
FG4402L10000	5" Rubber Swivel Caster	FG131500DBLUE	240
FG4402L10000	5" Rubber Swivel Caster	FG131500RED	240
FG4402L10000	5" Rubber Swivel Caster	FG131500YEL	240
FG4402L10000	5" Rubber Swivel Caster	FG440300BLA	323
FG4402L40000	8" Pneumatic Rigid Caster	FG443610BLA	218
FG4402L40000	8" Pneumatic Rigid Caster	FG446610BLA	218
FG4403L10000	Hardware Kit	FG440300	323
FG4403L10000	Hardware Kit	FG440600	218
FG4403L10000	Hardware Kit	FG443600	218
FG4403L10000	Hardware Kit	FG443610	218
FG4403L10000	Hardware Kit	FG444100	218
FG4403L10000	Hardware Kit	FG446200	220
FG4403L10000	Hardware Kit	FG446300	220
FG4403L10000	Hardware Kit	FG446400	220
FG4403L10000	Hardware Kit	FG446600	218
FG4403L10000	Hardware Kit	FG446700	220
FG4403L10000	Hardware Kit	FG446800	220
FG4403L10000	Hardware Kit	FG446900	220
FG4403L10000	Hardware Kit	FG447100	218
FG4403L10000	Hardware Kit	FG448600	223
FG4406L60000	6" Poly Swivel and Fixed Caster Replacement Kit	FG440600BLA	218
FG4436L80000	8" TPR Swivel and Fixed Caster Replacement Kit	FG443600BLA	218
FG4436L80000	8" TPR Swivel and Fixed Caster Replacement Kit	FG446600BLA	218
FG4436L80000	8" TPR Swivel and Fixed Caster Replacement Kit	FG448600BLA	223
FG4436M10000	8" Pneumatic Swivel & Fixed Caster Replacement Kit	FG443610BLA	218

COMPONENT PART	COMPONENT DESCRIPTION	FITS	PAGE # (OF 'FITS' SKU)
FG4436M10000	8" Pneumatic Swivel & Fixed Caster Replacement Kit	FG446610BLA	218
FG4441L10000	8" Poly Swivel and Fixed Caster Replacement Kit	FG444100BLA	218
FG4441L10000	8" Poly Swivel and Fixed Caster Replacement Kit	FG446300BLA	220
FG4441L10000	8" Poly Swivel and Fixed Caster Replacement Kit	FG446800BLA	220
FG4441L10000	8" Poly Swivel and Fixed Caster Replacement Kit	FG447100BLA	218
FG4500L50000	Hardware Kit	FG452010BEIG	230
FG4500L50000	Hardware Kit	FG452010BLA	230
FG4500M20000	Hardware Kit	FG450088BEIG	230
FG4500M20000	Hardware Kit	FG450088BLA	230
FG4500M20000	Hardware Kit	FG452010BEIG	230
FG4500M20000	Hardware Kit	FG452010BLA	230
FG4500M20000	Hardware Kit	FG452088BEIG	230
FG4500M20000	Hardware Kit	FG452088BLA	230
FG4500M20000	Hardware Kit	FG452500BEIG	230
FG4500M20000	Hardware Kit	FG452500BLA	230
FG4500M20000	Hardware Kit	FG454600BLA	230
FG4500M20000	Hardware Kit	FG454610BEIG	230
FG4500M20000	Hardware Kit	FG454610BLA	230
FG4501L10000	5" Rigid Caster	FG430000BLA	320
FG4501L10000	5" Rigid Caster	FG430000BLA	320
FG4501L10000	5" Rigid Caster	FG440100BLA	323
FG4501L10000	5" Rigid Caster	FG440100BLA	323
FG4501L10000	5" Rigid Caster	FG450088BEIG	230
FG4501L10000	5" Rigid Caster	FG450088BLA	230
FG4501L10000	5" Rigid Caster	FG450088BEIG	230
FG4501L10000	5" Rigid Caster	FG450088BLA	230
FG4501L10000	5" Rigid Caster	FG450500BEIG	230
FG4501L10000	5" Rigid Caster	FG450500BEIG	230
FG4501L10000	5" Rigid Caster	FG450500BLA	230
FG4501L10000	5" Rigid Caster	FG450500BLA	230
FG4501L10000	5" Rigid Caster	FG452500BEIG	230
FG4501L10000	5" Rigid Caster	FG452500BLA	230
FG4501L10000	5" Rigid Caster	FG618000BLA	227
FG4501L20000	5" Swivel Caster	FG440100BLA	323
FG4501L20000	5" Swivel Caster	FG450088BEIG	230
FG4501L20000	5" Swivel Caster	FG450088BLA	230
FG4501L20000	5" Swivel Caster	FG450500BEIG	230
FG4501L20000	5" Swivel Caster	FG450500BLA	230
FG4501L20000	5" Swivel Caster	FG452088BEIG	230
FG4501L20000	5" Swivel Caster	FG452088BLA	230
FG4501L20000	5" Swivel Caster	FG452500BEIG	230
FG4501L20000	5" Swivel Caster	FG452500BLA	230
FG4505L30000	Caster Kit for Flat Shelf Carts	FG450089BEIG	230
FG4505L30000	Caster Kit for Flat Shelf Carts	FG450089BLA	230
FG4505L30000	Caster Kit for Flat Shelf Carts	FG450500BEIG	230
FG4505L30000	Caster Kit for Flat Shelf Carts	FG450500BLA	230
FG4505L30000	Caster Kit for Flat Shelf Carts	FG450589BEIG	230
FG4505L30000	Caster Kit for Flat Shelf Carts	FG450589BLA	230
FG4505L30000	Caster Kit for Flat Shelf Carts	FG452089BEIG	230
FG4505L30000	Caster Kit for Flat Shelf Carts	FG452089BLA	230
FG4505L30000	Caster Kit for Flat Shelf Carts	FG452500BEIG	230
FG4505L30000	Caster Kit for Flat Shelf Carts	FG452500BLA	230
FG4505L30000	Caster Kit for Flat Shelf Carts	FG452589BEIG	230
FG4505L30000	Caster Kit for Flat Shelf Carts	FG452589BLA	230
FG4510L30000	Hardware Kit	FG450088BEIG	230
FG4510L30000	Hardware Kit	FG450088BLA	230
FG4510L30000	Hardware Kit	FG452088BLA	230
FG4510L30000	Hardware Kit	FG454600BEIG	230
FG4510L30000	Hardware Kit	FG454600BLA	230
FG4512L3RED	Left Door (Small) for TradeMaster® Cart	FG451288BLA	226
FG4512L4RED	Right Door (Small) for TradeMaster® Cart	FG451288BLA	226

UTILITY AND RECYCLING REFUSE

DECORATIVE REFUSE

CLEANING

MATERIAL HANDLING

WASHROOM

FOODSERVICE

ACCESSORIES & INDEX



COMPONENT PART	COMPONENT DESCRIPTION	FITS	PAGE # (OF 'FITS' SKU)
FG6189L30000	Vacuum Cleaner Holder Kit	FG619000BLA	200
FG6189L30000	Vacuum Cleaner Holder Kit	FG619100BLA	200
FG6189L30000	Vacuum Cleaner Holder Kit	FG619200BLA	200
FG6191L10000	Lock with Key Set	FG619100BLA	200
FG6191L10000	Lock with Key Set	FG619200BLA	200
FG6191L10000	Lock with Key Set	FG619700BLA	201
FG6191L10000	Lock with Key Set	FG9T1900BLA	200
FG7570L20000	3" Plastic Caster with Metal Axle	FG748000YEL	148
FG7570L20000	3" Plastic Caster with Metal Axle	FG757088YEL	149
FG7570L20000	3" Plastic Caster with Metal Axle	FG757688YEL	148
FG7570L20000	3" Plastic Caster with Metal Axle	FG757788BRN	146
FG7570L20000	3" Plastic Caster with Metal Axle	FG757788YEL	146
FG7570L20000	3" Plastic Caster with Metal Axle	FG758888BLUE	146
FG7570L20000	3" Plastic Caster with Metal Axle	FG758888GRN	146
FG7570L20000	3" Plastic Caster with Metal Axle	FG758888RED	146
FG7570L20000	3" Plastic Caster with Metal Axle	FG759088YEL	146
FG7570L20000	3" Plastic Caster with Metal Axle	FGQ93000BLUE	
FG7575L70000	Pan Head Screws (4)	FG757579YEL	149
FG7575L8BLA	WaveBrake® Gear and Rack Replacement	FG757588BLUE	149
FG7575L8BLA	WaveBrake® Gear and Rack Replacement	FG757588BRN	149
FG7575L8BLA	WaveBrake® Gear and Rack Replacement	FG757688YEL	148
FG7575L8BLA	WaveBrake® Gear and Rack Replacement	FG757788BRN	146
FG7575L8BLA	WaveBrake® Gear and Rack Replacement	FG757788YEL	146
FG7575L8BLA	WaveBrake® Gear and Rack Replacement	FG757888BLUE	146
FG7575L8BLA	WaveBrake® Gear and Rack Replacement	FG757888GRN	146
FG7575L8BLA	WaveBrake® Gear and Rack Replacement	FG757888RED	146
FG7806L8BLA	3 Point Strap For High Chair	FG780508BLA	314
FG7806L8BLA	3 Point Strap For High Chair	FG780508DGRN	314
FG7806L8BLA	3 Point Strap For High Chair	FG780608BLA	314
FG7806L8BLA	3 Point Strap For High Chair	FG780608DGRN	314
FG7806L8BLA	3 Point Strap For High Chair	FG780608PLAT	314
FG7806L8BLA	3 Point Strap For High Chair	FG781408BLA	314
FG7806L8BLA	3 Point Strap For High Chair	FG781408DGRN	314
FG7806L8BLA	3 Point Strap For High Chair	FG781408PLAT	314
FG7818L20000	Safety Strap Kit	FG781888PLAT	315
FG7818L40000	Baby Changing Station Horizontal Belt Kit	FG781888PLAT	315
FG7931L30000	6" Rigid Casters (2)	FG440300BLA	323
FG8170L1BEIG	Repleaceable Marshal Top with Hardware, Beige	FG817088BEIG	72
FG8170L1BEIG	Repleaceable Marshal Top with Hardware, Beige	FG817088BLA	72
FG8170L1BEIG	Repleaceable Marshal Top with Hardware, Beige	FG817088BRN	72
FG9054L2BLA	UBO Strap Replacement (2)	FG905800BLA	72
FG9054L2WGRAN	UBO Strap Replacement (2)	FG905886WGRAN	72
FG9171L4BLA	Base Ring	FG917188BEIG	74
FG9171L4BLA	Base Ring	FG917388BEIG	74
FG9171L4BLA	Base Ring	FG917388BLA	74
FG9171L4BLA	Base Ring	FG917500BEIG	74
FG9171L4BLA	Base Ring	FG917500BLA	74
FG9171L4BLA	Base Ring	FG917600BEIG	74
FG9171L4BLA	Base Ring	FG917600BLA	74
FG9511L2YEL	Middle Panel (2)	FG951100YEL	211

COMPONENT PART	COMPONENT DESCRIPTION	FITS	PAGE # (OF 'FITS' SKU)
FG9T06L10000	16" Pneumatic Tire	FG130641BLA	241
FG9T06L10000	16" Pneumatic Tire	FG131641BLA	241
FG9T13L30000	10" Wheel	FG9T1300BLA	239
FG9T13L30000	10" Wheel	FG9T1700BLA	240
FG9T14L10000	10" Wheel	FG9T1400BLA	239
FG9T15L10000	5" Swivel Caster	FG9T1500BLA	239
FG9T15L10000	5" Swivel Caster	FG9T1500BLA	239
FG9T15L10000	5" Swivel Caster	FG9T1600BLA	239
FG9T15L10000	5" Swivel Caster	FG9T1600BLA	239
FG9T17L10000	4" Swivel Caster	FG9T1700BLA	240
FG9T18L10000	4" Swivel Caster	FG9T1800BLA	240
FG9T28L3BLA	10ft Electrical Power Strip	FG9T3500BLA	235
FG9T57L2RED	Light Bulb Strap	FG9T5800BLA	228
FG9T57L5BLA	Strap For Ladder Cart	FG9T5800BLA	228
FG9T66L10000	5" Caster Kit	FG9T6600BLA	230
FG9T66L10000	5" Caster Kit	FG9T6700BLA	230
FG9T73L4BLA	Bottom Base	FG9T7200BLA	193
FG9T73L4BLA	Bottom Base	FG9T7300BLA	192
FG9T73L4BLA	Bottom Base	FG9T7400BLA	192
FG9T73L4BLA	Bottom Base	FG9T7500BLA	192
FG9T73L4BLA	Bottom Base	FG9T7800BLA	195
FG9T73L4BLA	Bottom Base	FG9T7900BLA	193
FG9T73L4BLA	Bottom Base	FG9T7900BLA	193
FG9T73L5BLA	Handle	FG9T7200BLA	193
FG9T73L5BLA	Handle	FG9T7300BLA	192
FG9T73L5BLA	Handle	FG9T7400BLA	192
FG9T73L5BLA	Handle	FG9T7500BLA	192
FG9T73L5BLA	Handle	FG9T7800BLA	195
FG9T73L5BLA	Handle	FG9T7900BLA	193
FG9T73L5BLA	Handle	FG9T7900BLA	193
FG9T73L60000	Aluminum Uprights Kit	FG9T7200BLA	193
FG9T73L60000	Aluminum Uprights Kit	FG9T7300BLA	192
FG9T73L60000	Aluminum Uprights Kit	FG9T7400BLA	192
FG9T73L60000	Aluminum Uprights Kit	FG9T7500BLA	192
FG9T73L60000	Aluminum Uprights Kit	FG9T7800BLA	195
FG9T73L60000	Aluminum Uprights Kit	FG9T7900BLA	193
FG9T73L60000	Aluminum Uprights Kit	FG9T7900BLA	193
FG9T73L8BLA	Folding Bag/Bucket Platform	FG9T7300BLA	192
FG9T73L8BLA	Folding Bag/Bucket Platform	FG9T7400BLA	192
FG9T73L8BLA	Folding Bag/Bucket Platform	FG9T7500BLA	192
FG9T73L8BLA	Folding Bag/Bucket Platform	FG9T7800BLA	195
FG9T73L8BLA	Folding Bag/Bucket Platform	FG9T7900BLA	193
FG9T73L8BLA	Folding Bag/Bucket Platform	FG9T9200BLA	194
FG9T73L9GRAY	Wheel & Axle Parts	FG9T7200BLA	193
FG9T73L9GRAY	Wheel & Axle Parts	FG9T7300BLA	192
FG9T73L9GRAY	Wheel & Axle Parts	FG9T7800BLA	195
FG9T73M20000	Lock And Key	FG9T7500BLA	192
FG9T73M20000	Lock And Key	FG9T7800BLA	195
FG9T73M4BLA	Tool Grip Rack and Caps	FG9T7200BLA	193
FG9T73M4BLA	Tool Grip Rack and Caps	FG9T7300BLA	192
FG9T73M4BLA	Tool Grip Rack and Caps	FG9T7400BLA	192
FG9T73M4BLA	Tool Grip Rack and Caps	FG9T7500BLA	192
FG9T73M4BLA	Tool Grip Rack and Caps	FG9T7800BLA	195
FG9T73M5BLA	Rubber Tool Grip	FG9T7200BLA	193
FG9T73M5BLA	Rubber Tool Grip	FG9T7300BLA	192
FG9T73M5BLA	Rubber Tool Grip	FG9T7400BLA	192
FG9T73M5BLA	Rubber Tool Grip	FG9T7500BLA	192
FG9T73M5BLA	Rubber Tool Grip	FG9T7800BLA	195
FG9T73M6BLA	Handle Tool Grip Cap	FG9T7200BLA	193
FG9T73M6BLA	Handle Tool Grip Cap	FG9T7300BLA	192
FG9T73M6BLA	Handle Tool Grip Cap	FG9T7400BLA	192
FG9T73M6BLA	Handle Tool Grip Cap	FG9T7500BLA	192
FG9T73M6BLA	Handle Tool Grip Cap	FG9T7800BLA	195
FG9T73M6BLA	Handle Tool Grip Cap	FG9T7900BLA	193
FG9T73M6BLA	Handle Tool Grip Cap	FG9T7900BLA	193
FG9W04L3BLA	Squeegee for Window Wash	FG9W0400BLA	77
FG9W21L10000	Wheel Set (2)	FG9W2100GRAY	99
FG9W21L2BLA	Replacement Rollout Axle Carriage	FG9W1188GRAY	100
FG9W21L2BLA	Replacement Rollout Axle Carriage	FG9W1900RED	101

UTILITY AND RECYCLING REFUSE

DECORATIVE REFUSE

CLEANING

MATERIAL HANDLING

WASHROOM

FOODSERVICE

ACCESSORIES & INDEX



COMPONENT PART	COMPONENT DESCRIPTION	FITS	PAGE # (OF 'FITS' SKU)
FG9W21L2BLA	Replacement Rollout Axle Carriage	FG9W2000RED	
FG9W21L2BLA	Replacement Rollout Axle Carriage	FG9W2100GRAY	99
FG9W21L2BLA	Replacement Rollout Axle Carriage	FG9W2200GRAY	99
FG9W27L10000	Replacement Wheels/Push Caps (2)	FG9W2700BLUE	99
FG9W27L10000	Replacement Wheels/Push Caps (2)	FG9W2700GRAY	99
FG9W27L10000	Replacement Wheels/Push Caps (2)	FG9W2700YEL	99
FG9W27L10000	Replacement Wheels/Push Caps (2)	FG9W2773BLUE	100
FG9W27L2BLA	Replacement Lid/Handle	FG9W2700BLUE	99
FG9W27L2BLA	Replacement Lid/Handle	FG9W2700GRAY	99
FG9W27L2BLA	Replacement Lid/Handle	FG9W2700YEL	99
FG9W27L2BLA	Replacement Lid/Handle	FG9W2773BLUE	100
FG9W31L1BLA	Funnel Top Domed Cap	FG9W3100SSBLA	82
FG9W31L1BLA	Funnel Top Domed Cap	FG9W3200SSBLA	82
FG9W31L1BLA	Funnel Top Domed Cap	FG9W3300BLA	82
FG9W34L1AGBRNZ	Domed Cap	FG9W3400AGBRNZ	82
FG9W34L1AGBRNZ	Domed Cap	FG9W3400ATPWTR	82
FG9W34L1AGBRNZ	Domed Cap	FG9W3400BLA	82
FG9W71L1GRAY	5" Caster Kit	FG9W7100BLA	
FG9W71L2BLA	12" Wheel Kit	FG9W7100BLA	
FG9W71L5RED	Door Latch, Red	FG9W7100BLA	
FG9W71L6BLA	Doors With Latch, Black	FG9W7100BLA	
FG9W71L8BLA	Hinge Kit	FG9W7100BLA	
FG9W87L1YEL	BRUTE® Rim Caddy Bag Strap, Yellow	FG9W8700YEL	95
FGQ966L10000	PULSE™ Caddy Connect	FGQ966000000	135
FGQ969L10000	PULSE™ Red Cap	1835529	137
FGQ969L10000	PULSE™ Red Cap	FGQ966000000	135
FGQ979L20000	FLOW™ Clean Connect	FGQ98900YL00	142

UTILITY AND
RECYCLING REFUSE

DECORATIVE REFUSE

CLEANING

MATERIAL HANDLING

WASHROOM

FOODSERVICE

ACCESSORIES
& INDEX



© 2019 Rubbermaid Commercial Products LLC
8900 Northpointe Executive Drive, Huntersville, NC 28078
Visit rubbermaidcommercial.com for more information.

RCP1566 REV 06/19



PROSMAN



www.prosman.com.mx

